

Springer Series in Computational Neuroscience

Axel Hutt *Editor*

Sleep and Anesthesia

Neural Correlates in Theory
and Experiment

 Springer

Springer Series in Computational Neuroscience

Volume 15

Series Editors

Alain Destexhe
CNRS
Gif-sur-Yvette
France

Romain Brette
École Normale Supérieure
Paris
France

For other titles published in this series, go to
www.springer.com/series/8164

Axel Hutt

Editor

Sleep and Anesthesia

Neural Correlates in Theory
and Experiment

 Springer

Editor

Axel Hutt
Equipe Cortex
INRIA CR Nancy
rue du Jardin Botanique 615
Villers-lès-Nancy CX 54602
France
axel.hutt@loria.fr

ISBN 978-1-4614-0172-8

e-ISBN 978-1-4614-0173-5

DOI 10.1007/978-1-4614-0173-5

Springer New York Dordrecht Heidelberg London

Library of Congress Control Number: 2011932794

© Springer Science+Business Media, LLC 2011

All rights reserved. This work may not be translated or copied in whole or in part without the written permission of the publisher (Springer Science+Business Media, LLC, 233 Spring Street, New York, NY 10013, USA), except for brief excerpts in connection with reviews or scholarly analysis. Use in connection with any form of information storage and retrieval, electronic adaptation, computer software, or by similar or dissimilar methodology now known or hereafter developed is forbidden.

The use in this publication of trade names, trademarks, service marks, and similar terms, even if they are not identified as such, is not to be taken as an expression of opinion as to whether or not they are subject to proprietary rights.

Cover design: After Ramón y Cajal

Organization of Computational Neuroscience: www.cnsorg.org

Printed on acid-free paper

Springer is part of Springer Science+Business Media (www.springer.com)

Foreword: Computing the Mind

After millennia of philosophical debate, neuroscience now tackles the problem of conscious experience. Cognitive neuroscience investigates the neural correlates of perception, action, and cognition in the conscious state. At the same time, anesthesia and sleep are the exclusive models for the investigation of the reversible transitions between conscious and unconscious states. Anesthesia is particularly useful in that it allows a controlled manipulation of the state of consciousness in a graded manner. While certain system parameters in the brain may change rather abruptly, changes in others are rather graded. The interplay of these processes creates an interesting dynamics that is characteristic to each anesthetic agent. The wide variety of known anesthetic agents with respect to their chemical structure and pharmacological profile allows the fine dissection of their specific molecular, synaptic neuronal effects that mediate the agents' local and global functional and behavioral effects. While we know a lot about the interaction of anesthetic agents with molecular and receptor targets, their actions at systems level trails in understanding. Since the early 1980s, metabolic and functional brain imaging has contributed significantly to the understanding of regional changes in the brain in both sleep and anesthesia. However the regional targets of drug effects underlying the observed images have been more difficult to identify. The brain is so highly interconnected that extrapolation of the underlying mechanism from empirical observations is nearly prohibitive. Theoretical models of causal interactions and computational approaches have been invoked to help overcome this difficulty.

Bridging molecular events that occur under anesthesia or sleep, systems level events, and observable behavior is obviously important for a full understanding of the underlying mechanisms. There has been few attempts to explicitly model large-scale interactions in the brain and to examine state-dependent changes in complexity and dynamics with respect to specific functional systems. In this regard, empirical investigations by functional brain imaging and quantitative electrophysiology are leading the progress ahead of systems modeling. Continued progress from modeling homogeneous systems to structured systems with identified neurofunctional modules and networks is necessary.

A gentle warning toward modeling efforts is in order. In order to describe reality more and more faithfully, computational models of the brain are getting more

and more complex. It becomes relatively easy to simulate a particular behavior, especially when modeling is guided by preconceived notions of what the result has to be. Without very tight experimental validation of all elements in the model, the modeling effort easily become circular. For example, we may think that we know from experimental studies how anesthetics alter the EEG, and we are able to simulate such EEG changes in a generic model of the cortical neuronal network, and then conclude that the model explains how anesthetics work. From this point of view, our experimental techniques lag behind our modeling armamentary; which highlights a serious need for advancing our measurement techniques. There is an appeal in keeping the models as simple as possible while reproducing a principal behavior of question, commensurate with the experimental data available to verify the predictions against.

As another cautionary example, many of the computational studies of EEG dynamics to date model anesthetic action or sleep as a reduction in high-frequency components in the beta–gamma range. But the notion that anesthetic agents attenuate these oscillations near the critical concentration that produces unconsciousness is not at all certain. In fact, experimental studies suggest that robust increases in gamma power occur near the transition point of conscious and unconscious states. Moreover, the results are different in humans, primates and small mammals. Yet all creatures can be anesthetized by the same drugs. This means that our current models are not flexible enough to account for the effect of various anesthetic agents, conditions and species. Yet to understand the specific neural correlates of unconsciousness, defined as minimal necessary conditions, we have to find the common ingredient, the final common pathway or functional change. This requirement continues to present a formidable challenge for future research. A synthesis of knowledge across all relevant levels of complexity and variability has not been achieved. However, the works presented in the current book collectively make a serious attempt toward this goal.

There is another, more fundamental issue that points to future perspectives. Most of the modeling work has been focused on particular features of brain dynamics. For example, in case of the EEG, the variables of interest that describe the dynamics include changes in spectrum, bispectrum, synchrony, coherence, state transition and fluctuation, etc. However, we are interested in the neural correlates of consciousness and its removal in unconsciousness. Can we say that a computer that generates particular waking EEG pattern is conscious? At this point of development, obviously not. Perhaps the dynamics has to be implemented in the wetware of the brain. But then something really important is missing from the model. Even if we interpret our results as a description, not simulation, of dynamics in the wetware of the brain, how do we know that this dynamics is sufficient for conscious experience? A zombie or a very smart computer may have the same dynamics, may be behaviorally awake, but not conscious. It may just process implicit (subconscious) information, in spite of the reproduced familiar functional patterns. But we do not yet know what would make this pattern or dynamics conscious as opposed to unconscious. We are facing

the famous explanatory gap between the objective and subjective realms.¹ Can we bridge this gap?

One possibility to make progress is to try to incorporate the missing “extra ingredient” that goes beyond brain dynamics. Short of assuming something extra-physical or transcendental, a possible postulate is information, particularly, integrated information. One then may ask the question: if a certain brain dynamics is present, does it entail processing of information? A modest first step is an attempt to measure the information capacity in a given brain state. This can be done in many different ways and at many levels from regional, columnar, neuronal, synaptic, receptor, molecular, and quantum levels. Clearly, the higher the resolution the higher the information capacity, but the unit of information in the brain is currently unclear. A second step is to realize that what really counts is integrated information.² A high number of parallel information channels transmits a large amount information but does not process it. It has large information capacity but lacks integration. Information processing involves the transformation, manipulation, storage and retrieval of information, together with plasticity of the functional architecture performing these operations. Moreover, integrated information is produced by a system with causal, generative architecture. The resulting dynamics of integrated information is thus thought to give rise to the stream of consciousness.

If consciousness is tied to integrated information, this implies that consciousness can be graded in its content and complexity. As the theory stands, the state of consciousness is determined by the total amount of integrated information alone. It has been postulated that in general anesthesia or dreamless sleep, when there is no subjective experience, information integration is reduced in a graded manner to a level incompatible with conscious perception and purposeful behavior.³ On the other hand, personal experience suggests that we normally lose consciousness abruptly, which may seem to conflict with the theorized graded nature of consciousness. However, such personal impression may in part be a result of amnesia under both anesthetic and sleep conditions. Also, numerous mathematical modeling studies, e.g. by Steyn-Ross and colleagues,⁴ suggested that rapid state transitions of neural dynamics can occur upon graded changes in model parameters relevant to anesthesia and sleep. Thus, even if consciousness might exist at many levels, the process of transition across these levels may be accelerated by physiological regulation, as in sleep-wake transitions, and pharmacological interventions, as in general anesthesia. This calls for an investigation of spontaneous transitions of the state of consciousness near the critical state while exogenous stimuli are controlled and neural parameters are recorded.

¹Chalmers DJ (1996) *The Conscious Mind: In Search of a Fundamental Theory*. Oxford University Press.

²Tononi G (2004) An information integration theory of consciousness. *BMC Neurosci* 5:42.

³Alkire MT, Hudetz AG and Tononi G (2008) Consciousness and anesthesia. *Science* 322(5903):876–880.

⁴Cf. Chap. 8 in this book.

Whether specific brain structures or cortical regions are more critical than others to support the degree of information integration necessary for consciousness is an area of active research. It is most likely that certain enabling systems, such as the ascending activating system, are necessary for information integration in the thalamocortical system. In addition, certain cortical regions may serve as hubs of information exchange and may thus be more critical targets of anesthesia than others. Moreover, different brain regions may play the primary role in removing vs. restoring the conscious state.

Finally, an important distinction to be made is the difference between wakefulness and consciousness because even coordinated movement and behavior does not imply the presence of conscious control, e.g., sleepwalking. It is correct when from gross movement or spontaneous speech the anesthesiologist concludes the patient is “waking up” but this may not be conscious awakening. Thus, the neural correlates of wakefulness and consciousness have to be considered separately. Our current models do not fully account for this difference. The same is true to falling asleep. A further distinction to be made is between losing consciousness (induction) and regaining consciousness (emergence), as these processes may, at least in part, be mediated by different mechanisms. To describe transitions in and out of consciousness during anesthesia or dreamless sleep, one should consider the neural correlates of induction, unconsciousness, and emergence separately.

Milwaukee, USA

Anthony G. Hudetz

Preface

Natural sleep and the accompanying loss of consciousness is part of everybody's life. Similarly, general anaesthesia is part of the daily routine in hospital surgery whose aim is, *inter alia*, to induce hypnosis in patients. The two phenomena share some common features, however differ in other aspects. For instance, it has been shown that the final state in deep sleep and anaesthetic-induced unconsciousness are remarkably similar. However a sleeper may be woken up by shaking or noise whereas an anaesthetized person cannot be brought back to consciousness by external stimuli.

Notwithstanding the importance of sleep for all mammals and many other species and the successful administration of general anaesthesia in surgery, the physiological mechanisms of sleep and anaesthesia are far from being understood. The current book aims to elucidate the similarities and differences of sleep and anaesthesia and gives an overview over corresponding experimental and theoretical techniques. The idea for the book came up after two workshops on the same topic that I had organized during the Computational Neuroscience Conferences 2007 in Toronto and 2009 in Berlin. Many of the contributors to this book have participated in these workshops and stimulated discussions triggered the idea to summarize the different experimental and theoretical approaches. Moreover, interestingly not few contributors to this book working on either sleep or anaesthesia have switched between the two topics in the last years illustrating the strong link between the two research topics.

Typical experiments apply invasive electrophysiology, encephalography and high-resolution imaging technique to extract neural correlates during sleep or anaesthesia. Theoretical models aim to explain the experimentally observed activity and attempt to extract the corresponding underlying neural mechanisms frequently by mathematical models. Since both approaches fertilize each other, the book brings together both experimental and theoretical studies reflecting the current status of research and demonstrating their strong link. The first chapter introduces to the physiological basis of sleep and anaesthesia mostly based on experiments and discusses similarities and differences in physiology. The subsequent chapter then introduces into a unifying theoretical model which explains elements of both sleep and anaes-

thetia. More detailed investigations on either sleep or anaesthesia follow in the subsequent two separate sections.

The book gives an overview of the major approaches and concepts in experiments and theory and hence is ideal for graduate students in anesthesiology and sleep science. It also serves theoretical neuroscientists who are new to anesthesia and sleep and would like to gain an overview of the recent theoretical achievements and hypothesis.

I like to thank the staff of Springer–New York, especially Ann Avouris, for tireless assistance and support to make this book happen.

Nancy, France

Axel Hutt

Contents

1	Sleep and Anesthesia: A Consideration of States, Traits, and Mechanisms	1
	D. Pal and G.A. Mashour	
2	Modelling Sleep and General Anaesthesia	21
	J.W. Sleigh, L. Voss, M.L. Steyn-Ross, D.A. Steyn-Ross, and M.T. Wilson	
Part I Sleep		
3	Quantitative Modeling of Sleep Dynamics	45
	P.A. Robinson, A.J.K. Phillips, B.D. Fulcher, M. Puckeridge, J.A. Roberts, and C.J. Rennie	
4	The Fine Structure of Slow-Wave Sleep Oscillations: from Single Neurons to Large Networks	69
	A. Destexhe and D. Contreras	
5	A Population Network Model of Neuronal and Neurotransmitter Interactions Regulating Sleep–Wake Behavior in Rodent Species . .	107
	C.G. Diniz Behn and V. Booth	
6	Neural Correlates of Human NREM Sleep Oscillations	127
	A. Foret, A. Shaffii-Le Bourdieu, V. Muto, L. Mascetti, L. Matarazzo, C. Kussé, and P. Maquet	
Part II Anesthesia		
7	A Mesoscopic Modelling Approach to Anaesthetic Action on Brain Electrical Activity	139
	D.T.J. Liley, B.L. Foster, and I. Bojak	
8	Progress in Modeling EEG Effects of General Anesthesia: Biphasic Response and Hysteresis	167
	D.A. Steyn-Ross, M.L. Steyn-Ross, J.W. Sleigh, and M.T. Wilson	

9 EEG Modeling in Anesthesia: A New Insight into Mean-Field Approach for Delta Activity Generation 195
B. Molaee-Ardekani, M.B. Shamsollahi, and L. Senhadji

10 A Neural Population Model of the Bi-phasic EEG-Power Spectrum During General Anaesthesia 227
A. Hutt

11 In-vivo Electrophysiology of Anesthetic Action 243
F. von Dincklage and B. Rehberg

Index 257

Contributors

Ingo Bojak School of Psychology (CN-CR), University of Birmingham, Edgbaston, Birmingham B15 2TT, UK, i.bojak@bham.ac.uk

Victoria Booth Department of Mathematics and Department of Anesthesiology, University of Michigan, Ann Arbor, MI 48109, USA, vbooth@umich.edu

Diego Contreras Department of Neuroscience, University of Pennsylvania, Philadelphia, USA

Alain Destexhe Unité de Neurosciences, Information et Complexité (UNIC), CNRS, 1 Avenue de la Terrasse (Bat. 33), 91190 Gif-sur-Yvette, France, Destexhe@unic.cnrs-gif.fr

Falk von Dincklage Department of Anesthesiology, Charité, Universitätsmedizin Berlin, Berlin, Germany, falk.von-dincklage@charite.de

Cecilia G. Diniz Behn Department of Mathematics, University of Michigan, Ann Arbor, MI 48109, USA

Ariane Foret Cyclotron Research Centre, University of Liège, 8, Allée du 6 Août, 4000 Liège, Belgium, aforet@ulg.ac.be

Brett L. Foster Department of Neurology and Neurological Sciences, Stanford University, Stanford, CA 94305, USA, blfoster@stanford.edu

Ben D. Fulcher Department of Physics, Clarendon Laboratory, Oxford University, Parks Rd., Oxford, OX1 3PU, UK, b.fulcher1@physics.ox.ac.uk

Axel Hutt Team CORTEX, INRIA Grand Est – Nancy, 615 rue du Jardin Botanique, 54602 Villers-les-Nancy, France, axel.hutt@inria.fr

Caroline Kussé Cyclotron Research Centre, University of Liège, 8, Allée du 6 Août, 4000 Liège, Belgium, Caroline.Kusse@gmail.com

David T.J. Liley Brain and Psychological Sciences Research Centre (BPsyC), Swinburne University of Technology, P.O. Box 218, Hawthorn, VIC 3122, Australia, dliley@swin.edu.au

Pierre Maquet Cyclotron Research Centre, University of Liège, 8, Allée du 6 Août, 4000 Liège, Belgium, pmaquet@ulg.ac.be

Laura Mascetti Cyclotron Research Centre, University of Liège, 8, Allée du 6 Août, 4000 Liège, Belgium, lmascetti@student.ulg.ac.be

George A. Mashour Department of Anesthesiology, University of Michigan Medical School, Ann Arbor, MI, USA, gmashour@umich.edu; University of Michigan Medical School, 1H247 University Hospital, SPC-5048, 1500 East Medical Center Drive, Ann Arbor, MI 48109-5048, USA

Luca Matarazzo Cyclotron Research Centre, University of Liège, 8, Allée du 6 Août, 4000 Liège, Belgium, lmatarazzo@ulg.ac.be

Behnam Molaee-Ardekani LTSI, University of Rennes 1, Inserm U642, Rennes 35000, France, molaee-ardekani@ieee.org

Vincenzo Muto Cyclotron Research Centre, University of Liège, 8, Allée du 6 Août, 4000 Liège, Belgium, vincenzomuto@msn.com

Dinesh Pal Department of Anesthesiology, University of Michigan Medical School, Ann Arbor, MI, USA

Andrew J.K. Phillips Division of Sleep Medicine, Brigham Women's Hospital, Harvard Medical School, 221 Longwood Ave, Suite 438, Boston, MA 02115, USA, ajphillips@partners.org

Max Puckeridge School of Physics, The University of Sydney, Sydney, NSW 2006, Australia, mpuc8976@physics.usyd.edu.au

Benno Rehberg Department of Anesthesiology, Charité, Universitätsmedizin Berlin, Berlin, Germany, Benno.Rehberg-Klug@hcuge.ch; Service d'Anesthésiologie, Hôpitaux Universitaires de Genève, Rue Gabrielle-Perret-Gentil 4, 1211 Genève 14, Switzerland

Chris J. Rennie School of Physics, The University of Sydney, Sydney, NSW 2006, Australia, chris_rennie@wmi.usyd.edu.au; Department of Medical Physics, Westmead Hospital, Westmead, NSW 2145, Australia; Brain Dynamics Center, Sydney Medical School – Western, University of Sydney, Westmead, NSW 2145, Australia

James A. Roberts School of Physics, The University of Sydney, Sydney, NSW 2006, Australia, jamesr@physics.usyd.edu.au; Brain Dynamics Center, Sydney Medical School – Western, University of Sydney, Westmead, NSW 2145, Australia

Peter A. Robinson School of Physics, The University of Sydney, Sydney, NSW 2006, Australia, robinson@physics.usyd.edu.au; Brain Dynamics Center, Sydney Medical School – Western, University of Sydney, Westmead, NSW 2145, Australia;

Center for Integrated Research and Understanding of Sleep, 431 Glebe Point Rd, Glebe, NSW 2037, Australia

Lofti Senhadji LTSI, University of Rennes 1, Inserm U642, Rennes 35000, France, lotfi.senhadji@univ-rennes1.fr

Anahita Shaffii-Le Bourdieu Cyclotron Research Centre, University of Liège, 8, Allée du 6 Août, 4000 Liège, Belgium

Mohammad B. Shamsollahi BiSIPL, Department of Electrical Engineering, Sharif University of Technology, Tehran, Iran, mbshams@sharif.edu

Jamie W. Sleigh Department of Anaesthesia, Waikato Clinical School, University of Auckland, Hamilton, New Zealand, sleighj@waikatodhb.govt.nz; Waikato Clinical School, University of Auckland, Waikato Hospital, Hamilton 3204, New Zealand

Alistair D. Steyn-Ross Department of Engineering, University of Waikato, P.B. 3105, Hamilton 3240, New Zealand, asr@waikato.ac.nz; School of Electronic Engineering, University of Waikato, Hamilton, New Zealand

Moira L. Steyn-Ross Department of Engineering, University of Waikato, P.B. 3105, Hamilton 3240, New Zealand, msr@waikato.ac.nz; School of Electronic Engineering, University of Waikato, Hamilton, New Zealand

Logan Voss Department of Anaesthesia, Waikato Clinical School, University of Auckland, Hamilton, New Zealand

Marcus T. Wilson Department of Engineering, University of Waikato, P.B. 3105, Hamilton 3240, New Zealand, m.wilson@waikato.ac.nz; School of Electronic Engineering, University of Waikato, Hamilton, New Zealand

Chapter 1

Sleep and Anesthesia: A Consideration of States, Traits, and Mechanisms

D. Pal and G.A. Mashour

1.1 Introduction

Sleep and anesthesia are distinct states of consciousness that share numerous traits. Like anesthesia, sleep is characterized by the loss of consciousness, behavioral immobility and little recall of environmental events (Pace-Schott and Hobson 2002; Tung and Mendelson 2004). However, unlike anesthesia, sleep is a spontaneous and endogenous process, shows homeostatic and circadian regulation, can be reversed with external stimuli and does not eliminate the sensitivity to pain (Pace-Schott and Hobson 2002; Tung and Mendelson 2004). As opposed to the historical viewpoint of sleep as a passive process consisting of the mere cessation of waking, it is now well established that sleep is actively generated from the interaction of distinct brain nuclei (Steriade and McCarley 2005). There is now experimental evidence supporting the earlier hypothesis (Lydic and Biebuyck 1994) that the effects of anesthesia may also be mediated through the subcortical brain nuclei that control sleep–wake states (Franks 2008; Lydic and Baghdoyan 2005). In this chapter, we will elaborate on the phenomenology and mechanism of sleep and anesthesia, discussing the similarities as well as differences.

1.2 Sleep—A Physiological Altered State of Consciousness

Sleep can be defined as a naturally occurring physiological altered state of consciousness. A consensus definition of consciousness eludes the scientific community, although most of the definitions would include brain arousal and subjective

G.A. Mashour (✉)

University of Michigan Medical School, 1H247 University Hospital, SPC-5048, 1500 East Medical Center Drive, Ann Arbor, MI 48109-5048, USA

e-mail: gmashour@umich.edu

experience as two critical components. In common parlance, ‘conscious’ connotes awake or aroused and is often used interchangeably with the term ‘aware.’ Scientifically, ‘aware’ implies the realization of external and internal cues that together define the world around us and is not the same as being awake or aroused. The dissociation of arousal and awareness is evidenced by patients in vegetative states, who exhibit periodic electroencephalographic arousal in the presumed absence of awareness. A distinction between ‘arousal’ and ‘awareness’ is important because our understanding of sleep–wake processes is derived primarily from animal experimentation that relies solely on the ‘arousal’ component that can be objectively assessed, but does not take into consideration the subjective ‘awareness’ component of consciousness.

Humans have been fascinated with the phenomena of sleep–wake states since the advent of civilization. Some of the oldest references alluding to sleep–wake phenomena can be found in ancient Hindu philosophical texts (Mandukya Upanishads, 16–11 BC). However, because of the lack of objective experimental tools, it was not until the twentieth century that any focused experimental approach could be applied to study sleep–wake states (Gottesmann 2001). The introduction of electrophysiological techniques, in particular electroencephalography, to study sleep–wake states brought the much needed measure of objectivity to an otherwise highly speculative field. The advent of electroencephalography spurred intense efforts to describe brain activity during sleep–wake states, which culminated in the serendipitous discovery of the state of rapid eye movement (REM) sleep (Aserinsky and Kleitman 1953; see Gottesmann 2001 for an excellent review). It was known that the wake state is marked by low-voltage high-frequency electroencephalogram (EEG) that changes to high-voltage low-frequency at the onset of behavioral sleep (Gottesmann 2001). Aserinsky and Kleitman (1953) first reported the occurrence of low-voltage EEG during behavioral sleep, which otherwise could be observed during the wake state. The low-voltage EEG episodes were accompanied by bursts of rapid eye movements, leading Aserinsky and Kleitman (1953) to coin the term REM sleep. Shortly afterwards, a similar state in cats was demonstrated by Dement (1958). Around the same time Jouvet and colleagues (1959) reported that low-voltage EEG episodes during sleep are accompanied by complete atonia of the neck muscles, thus unraveling a hallmark and unique feature of the state of REM sleep. It was also found that during this state, cats exhibited an increased arousal threshold, which was paradoxical because the electroencephalographic recordings showed an active EEG pattern as was observed during the wake state (Jouvet 2004). This led Jouvet (2004) to name the state of REM sleep as ‘paradoxical’ sleep or ‘rhombencephalic sleep’ because of the rhombencephalic or hindbrain/brainstem origin. The discovery of REM sleep was a paradigm shift in the conceptual understanding of sleep because it became obvious that sleep is not a homogeneous state. Because of the distinct REM sleep phase, the rest of the high-voltage low-frequency sleep period came to be known as non-REM (NREM) sleep.

Besides the changes in EEG, there are distinct physiological changes associated with different sleep states. During NREM sleep, brain metabolism, cerebral blood flow, heart rate and blood pressure decrease while the onset of REM sleep

causes a marked increase in all of these physiological processes (Rechtschaffen and Siegel 2000). Brain temperature, which decreases during NREM sleep, increases with the onset of REM sleep (Rechtschaffen and Siegel 2000). The neural activity and hence the neurochemical milieu of the brain shows specific changes associated with different sleep–wake states. The monoaminergic neurons [locus coeruleus (LC)—noradrenergic, dorsal raphe (DR)—serotonergic, and tuberomammillary nucleus (TMN)—histaminergic] discharge at the highest rate during wakefulness, slow down at the onset of NREM sleep and reach the lowest point of activity during REM sleep (Aston-Jones and Bloom 1981; Lin 2000; Lydic et al. 1987; Pace-Schott and Hobson 2002; Steriade and McCarley 2005). The cholinergic neurons in laterodorsal/pedunculopontine tegmentum (LDT/PPT) and basal forebrain (BF) show increased discharge with electroencephalographic arousal as during wakefulness and REM sleep (Jones 2008; Thakkar et al. 1998). A state-dependent modulation of GABAergic tone has been reported from multiple sleep–wake-related areas across the brain (Hassani et al. 2010; Pal and Mallick 2010; Steriade and McCarley 2005; Szymusiak et al. 2007). The changes in regional neuronal activity have been broadly confirmed through neuroimaging studies, which showed (i) a selective deactivation of brainstem, thalamus and BF/hypothalamic region during NREM sleep, and (ii) activation of pontine tegmentum, thalamus and BF during REM sleep (Dang-Vu et al. 2007).

Although the universality of sleep is a matter of intense debate (Mignot 2008; Siegel 2008; Zimmerman et al. 2008), all mammals (terrestrial and marine) as well as birds studied so far show NREM and REM sleep (Siegel 2008). Further, it is to be noted that although characterization of sleep–wake states based on electrophysiological parameters has been successful in humans as well as in laboratory animals, there seems to be a compelling argument to include behavioral criteria to define sleep in species in which electrophysiological recording is not feasible either because of the lack of brain structures comparable to mammals or because of the ecological niche (Siegel 2008; Zimmerman et al. 2008). Our current understanding of sleep–wake phenomena is based on the data from laboratory animals (mostly from cats, rats and mice) and clinical studies. However, unlike human sleep, there is no consensus on the characterization of sleep states in animals, leading to a varied description of sleep states by different laboratories. In addition, interspecies differences in sleep architecture and underlying processes have been shown from the behavioral to cellular level, thus making it imperative to exercise caution when extrapolating the results to humans (Capece et al. 1999; Siegel 2008).

1.2.1 Brain Mechanisms Underlying Wakefulness and NREM Sleep Generation/Regulation

Role of forebrain in sleep–wake generation/regulation The first clear assertion of sleep as an active phenomenon and the existence of sleep and wake regulatory centers can be attributed to Constantin von Economo (reviewed in Triarhou 2006).

He observed that some of the patients afflicted with encephalitica lethargica, the disease that now bears his name, showed extreme lethargy and somnolence whereas other patients in the chronic phase showed insomnia. On the basis of postmortem neuropathological observations, he concluded that the area encompassing posterior hypothalamus/rostral midbrain is involved in wake regulation whereas the anterior hypothalamic region regulates sleep. His clinical observations were later confirmed by experimental evidence that showed the presence of a sleep-promoting structure in the anterior hypothalamus (preoptic area—POA) and a wake-promoting structure in the posterior hypothalamus (Steriade and McCarley 2005; Szymusiak et al. 2007).

Loss/gain of function studies as well as physiological data from neuronal recordings have provided considerable insights into the functioning of the subdivisions of the hypothalamic region in sleep–wake regulation (Szymusiak et al. 2007). Thus, the median preoptic (MnPO) and ventrolateral preoptic (VLPO) subdivisions of the anterior hypothalamic/POA have GABAergic neurons that show increased discharge rate during NREM sleep and are sleep-active neurons (Szymusiak et al. 2007). TMN in posterior hypothalamus (PH) and perifornical area in the lateral hypothalamus (LH) have histaminergic and orexinergic neurons, respectively, both of which are the ‘wake-ON’ type of neurons (Szymusiak et al. 2007). LH also contains GABAergic neurons intermingled with orexinergic neurons and neurons positive for melanin concentrating hormones (MCH). A recent report showed that in contrast to the orexinergic neurons, which discharge at highest rate during wakefulness, the GABAergic and MCH containing neurons in LH are inactive during wake state and instead fire during sleep (Hassani et al. 2009, 2010; Jones 2008). Therefore, within LH there are two opposing influences on sleep–wake states—orexinergic neurons promote wake/arousal and GABA and MCH positive neurons promote sleep. Cholinergic neurons in the BF are active during wakefulness and REM sleep (Jones 2008), thus contributing to cortical activation. Co-distributed with cholinergic neurons in the BF are GABAergic neurons, which are active during sleep (Jones 2008). To summarize, the forebrain has arousal promoting neurons in (i) LH (orexinergic), (ii) PH (histaminergic) and (iii) BF (cholinergic) whereas sleep related neurons are (i) GABAergic neurons located in VLPO, MnPO, LH and BF, and (ii) MCH neurons in LH (Hassani et al. 2009, 2010; Jones 2008; Lin 2000; Szymusiak et al. 2007).

Role of brainstem in sleep–wake generation/regulation The forebrain is capable of maintaining states resembling sleep and wakefulness in isolation from the rest of the brain (Villablanca 2004). However, normal sleep–wake states are a result of the interaction between forebrain and brainstem processes. There are reciprocal connections between forebrain and brainstem sleep–wake-related neurons (Franks 2008; Jones 2008; Szymusiak et al. 2007; Villablanca 2004). The pioneering studies done in the laboratory of Horace Magoun unequivocally demonstrated the role of rostral brainstem/midbrain in arousal and EEG activation. Electrical stimulation of the midbrain reticular formation (MRF) produced EEG activation (Moruzzi and Magoun 1949) whereas lesions in the midbrain tegmentum caused behavioral stupor and a continuous synchronized (high-voltage low-frequency) EEG (Lindsley

et al. 1949). Neuronal recordings showed the presence of wake-related neurons in MRF (Manohar et al. 1972) and electrical stimulation of MRF excited the wake-ON neurons in LC (Thankachan et al. 2001). Inactivation of MRF and the anterior pontine region by intracarotid injection of thiopental replaced the low-voltage high-frequency EEG with high-voltage low-frequency EEG (Magni et al. 1959). Similar inactivation of the posterior pontine region and medulla oblongata by intravertebral injections resulted in EEG activation, thus indicating the presence of a hypnogenic influence in the caudal brainstem (Magni et al. 1959). Stimulation of the medullary nucleus of the solitary tract (NTS) in caudal brainstem produced EEG synchronization (Magnes et al. 1961) while microinjection of morphine into NTS caused a dose-dependent increase in NREM sleep (Reinoso-Barbero and de Andres 1995). Stimulation of caudal brainstem in free moving, normally behaving cats produced an excitatory effect on the REM-ON neurons in PPT (Mallick et al. 2004). Similar mild electrical stimulation of prepositus hypoglossi in rats increased sleep (Kaur et al. 2001). Further, a recent study has shown the presence of neurons active during REM sleep in dorsal paragigantocellular nucleus (Goutagny et al. 2008). Collectively, these studies demonstrate the role of midbrain in arousal and caudal brainstem in sleep-promoting activity.

1.2.2 Brain Mechanisms Underlying REM Sleep Generation/Regulation

Noradrenergic and cholinergic regulation of REM sleep Brainstem transections along the neuraxis showed that the ponto-medullary region plays a critical role in the generation of REM sleep (Jouvet 1962; Siegel et al. 1984; Vanni-Mercier et al. 1989). Extracellular recordings from different brainstem sites provided the crucial insights into the neural circuitry involved in REM sleep regulation. Initial studies showed the presence of neurons in pontine reticular formation (PRF) that (i) increase discharge before the onset of REM sleep and continue for the duration of the state, known as REM-ON neurons, and (ii) decrease discharge before the onset of REM sleep and remain suppressed for the duration of the state, known as REM-OFF neurons (Chu and Bloom 1974; Hobson et al. 1975; McGinty and Harper 1976; Vertes 1977). Refinement of the histological techniques over the decades allowed the identification of these REM sleep related neurons. Thus, the monoaminergic REM-OFF neurons in the pontine region—noradrenergic neurons in LC and serotonergic neurons in DR—show a state-dependent discharge with maximum activity during wakefulness, which progressively decreases through NREM sleep to almost cessation during REM sleep (Aston-Jones and Bloom 1981; Lydic et al. 1987). The cholinergic neurons in LDT/PPT in the pontine region can be categorized into two sub-populations: (i) REM-ON neurons that start firing just before the onset of REM sleep, and (ii) wake-ON/REM-ON neurons that fire during both wake and REM sleep states (Thakkar et al. 1998). Stimulation of LC, the site of REM-OFF neurons, decreases REM sleep (Singh and Mallick 1996)

whereas stimulation of LDT/PPT increases REM sleep (Datta and Siwek 1997; Thakkar et al. 1996). LC and LDT/PPT receive orexinergic projections from wake-active perifornical hypothalamic neurons (Peyron et al. 1998). Disinhibition of perifornical hypothalamic neurons excites LC noradrenergic neurons (Lu et al. 2007) and bath application of orexin depolarizes PPT cholinergic neurons (Kim et al. 2009). Infusion of orexin, an excitatory neuropeptide, into LC and LDT increased waking and decreased REM sleep (Bourgin et al. 2000; Xi et al. 2001).

LC and LDT/PPT share reciprocal anatomical connections and the neurochemical interplay between the monoaminergic and cholinergic neurons plays a fundamental role in the generation and maintenance of REM sleep (Hobson et al. 1975; Steriade and McCarley 2005). Pharmacological blockade of cholinergic transmission in LC decreases REM sleep (Mallick et al. 2001) whereas blocking noradrenergic transmission in PPT increases REM sleep (Pal and Mallick 2006). Cholinergic efferents from LDT/PPT innervate PRF, which is also known as the REM sleep induction zone (Reinoso-Suárez et al. 2001). Stimulation of PPT increases acetylcholine (ACh) release in PRF (Lydic and Baghdoyan 1993) and ACh levels increase in PRF during spontaneous REM sleep (Lydic and Baghdoyan 2005). Microinjection of cholinergic agonists into PRF increases REM sleep (Baghdoyan et al. 1984), which can be blocked by systemic co-administration of a cholinergic antagonist (Baghdoyan et al. 1989). Therefore, ACh plays an executive role whereas noradrenaline plays a permissive role in REM sleep generation.

Role of GABA in REM sleep generation An increasing number of studies indicate that GABA plays a central role in the generation of REM sleep, possibly through the modulation of pontine REM-OFF and REM-ON neurons (Pal and Mallick 2011). GABAergic neurons in LC and LDT/PPT are active during recovery REM sleep following REM sleep deprivation (Maloney et al. 1999). GABA concentration increases in LC during REM sleep (Nitz and Siegel 1997). Enhancement of GABAergic transmission in LC through GABA microinjection (Mallick et al. 2001) or stimulation of prepositus hypoglossi, which increases GABA concentration in LC, increases REM sleep (Kaur et al. 2001). Microinjection of GABA antagonist into LC decreases REM sleep (Mallick et al. 2001) whereas iontophoretic application of GABA into LC inhibits the putative noradrenergic REM-OFF neurons (Gervasoni et al. 1998). LC receives GABAergic projections from the extended VLPO area and these neurons have been shown to be active during REM sleep (Lu et al. 2002). Microinjection of GABA-A antagonist into PPT decreases REM sleep (Pal and Mallick 2004; Torterolo et al. 2002) whereas GABA-A agonist injection into PPT increases REM sleep (Pal and Mallick 2009; Torterolo et al. 2002). Pharmacological stimulation of GABAergic substantia nigra pars reticulata, which should increase GABA levels in PPT, increased the time spent in REM sleep (Pal and Mallick 2009). Therefore, GABA in LC and PPT promotes REM sleep (Mallick et al. 2001; Nitz and Siegel 1997; Pal and Mallick 2004, 2009; Torterolo et al. 2002). In addition, there is strong evidence that GABA from ventrolateral periaqueductal gray and dorsal paragigantocellular nucleus plays a critical role in REM sleep regulation, possibly through the modulation of the pontine monoaminergic and cholinergic neurons

(Goutagny et al. 2008; Sastre et al. 1996; Vanini et al. 2007). Interestingly, a recent study showed that the GABA levels in mPRF are lowest during REM sleep as compared to wake state (Vanini et al. 2011). This is in contrast to LC and LDT/PPT where the GABA level/tone is high during REM sleep (Nitz and Siegel 1997; Maloney et al. 1999). Therefore, the GABAergic modulation of sleep–wake states is site dependent.

1.3 Anesthesia—A Pharmacological Induced Altered State of Consciousness

Sleep is a ubiquitous metaphor for the state of general anesthesia because it serves as our experiential basis of unconsciousness and has the reassuring association with restoration. Sleep, like anesthesia, is characterized by the loss of consciousness. The decrease in global cerebral metabolism during NREM sleep is similar to that observed under anesthesia (Boveroux et al. 2008). Furthermore, regionally specific metabolic decreases in the polymodal cortices (the fronto-parietal network) during NREM sleep is comparable to that occurring under intravenous (IV) and inhalational anesthesia (Boveroux et al. 2008). Most general anesthetics produce high-voltage low-frequency EEG, which is also a characteristic feature of NREM sleep. Halothane and propofol cause spindles in EEG, which show a remarkable similarity to the spindles occurring during NREM sleep (Ferenets et al. 2006; Keifer et al. 1996). In spite of the apparent similarities in the behavioral and electroencephalographic traits, sleep and anesthesia have notable differences. Sleep is a naturally occurring altered state of consciousness whereas anesthesia is exogenously induced. As opposed to anesthesia, sleep does not eliminate the sensitivity to pain, is homeostatically regulated and is tightly coupled with hormonal release. Unlike sleep, the neurophysiology of general anesthesia is not characterized by cycles of cortical deactivation and activation, but rather a stable pattern once steady-state drug levels have been achieved. Furthermore, electrophysiological correlates of deeper anesthesia such as burst suppression are not observed during natural sleep.

There is a growing body of literature supporting the thought that loss of consciousness associated with anesthesia results in part from the activity at the subcortical nuclei involved in sleep–wake regulation (Franks 2008; Lydic and Baghdoyan 2005; Lydic and Biebuyck 1994). Anesthetics can induce loss of consciousness by inactivating the arousal-related centers or by activating the sleep or EEG synchrony areas. The arousal network is comprised of (i) monoaminergic neurons in LC, DR, TMN, (ii) cholinergic neurons in LDT/PPT and BF, and (iii) orexinergic neurons in LH-perifornical area (Franks 2008; Jones 2008; Lydic and Baghdoyan 2005; Steriade and McCarley 2005). The sleep or EEG synchrony-inducing neurons are located in anterior hypothalamic-POA, BF and NTS (Magnes et al. 1961; Mallick et al. 1983; Szymusiak et al. 2007). Redundancy is a common feature of the central nervous system, which is also true for sleep–wake/arousal pathways. The redundancy of the sleep–wake structures was highlighted by a recent report

that the daily wake levels were unaltered after the ablation of three arousal-related neuronal populations—cholinergic BF, noradrenergic LC and histaminergic TMN (Blanco-Centurion et al. 2007). Therefore, it is unlikely that any one group of neurons will be sufficient to generate arousal or sleep states. By corollary, it can be argued that a functional network rather than a single locus may underlie the state of anesthesia. Although more is known about the neuronal structures involved in sleep–wake regulation (Franks 2008; Jones 2008; Lydic and Baghdoyan 2005; Steriade and McCarley 2005), our understanding of the mechanism underlying the anesthetic-induced loss of consciousness is rapidly growing.

1.3.1 GABAergic Processes and Anesthetic Mechanisms

GABA-A agonist injection into the septohippocampal system potentiates the effect of general anesthetics by reducing the dose required for the induction of loss of righting reflex (Ma et al. 2002). Infusion of muscimol, a GABA-A agonist, into TMN produced a dose-dependent sedation as measured by the loss of righting reflex (Nelson et al. 2002). By contrast, GABA antagonism in TMN decreases the efficacy of systemically administered propofol and pentobarbital as reflected by a decrease in the duration of loss of righting reflex (Nelson et al. 2002). Devor and Zalkind (2001) reported that infusion of pentobarbital into mesopontine tegmentum induced a short latency, short lasting anesthesia-like state, which is similar to the state of anesthesia induced by systemic pentobarbital injection. The pentobarbital microinjection into mesopontine tegmentum caused a marked decrease in the neuronal activity (as measured by c-fos assay) throughout the cerebral cortex as well as subcortical structures, an effect replicated by intraperitoneal pentobarbital administration (Abulafia et al. 2009). Interestingly, lidocaine injection into the same site did not induce an anesthesia-like state, which indicates that the pentobarbital-induced loss of consciousness is not mediated through the local inactivation of this area (Devor and Zalkind 2001). It has been demonstrated that carbachol (cholinergic agonist) injections in and around mesopontine tegmentum induces REM sleep in rats (Bourgin et al. 1995), indicating similar neuroanatomic loci underlying sleep and anesthesia. Further, a number of studies have demonstrated the effect of GABA-active sedative/anesthetics on sleep architecture and sleep–wake-related areas. Systemic administration of pentobarbital and propofol (i) increased c-fos expression in VLPO, which is a part of the sleep-promoting network, and (ii) decreased c-fos expression in TMN, which is a part of the arousal promoting network (Nelson et al. 2002). Barbiturates (pentobarbital) and benzodiazepines administered systemically at sub-anesthetic doses increase the intermediate stage of sleep at the expense of REM sleep (Gottesmann et al. 1998). Infusion of pentobarbital (Mendelson 1996), triazolam (Mendelson and Martin 1992) and propofol (Tung et al. 2001a) into medial preoptic area decreased sleep latency and increased NREM sleep. GABA in medial pontine reticular formation (mPRF) increases arousal (Xi et al. 1999) whereas GABA levels in mPRF decrease during isoflurane anesthesia (Vanini et al. 2008).

Increasing GABA transmission in mPRF increased the isoflurane induction time (i.e., reduced efficacy) whereas decreasing GABA transmission in the same site decreased isoflurane induction time (Vanini et al. 2008). Keifer et al. (1996) reported that halothane decreases the release of ACh in mPRF. Infusion of GABA antagonist into mPRF increases ACh release, possibly by blocking the pre-synaptic GABAergic receptors on the cholinergic terminals (Vazquez and Baghdoyan 2004). In a recent study, Vanini et al. (2011) showed a significant increase in PRF GABA levels during wake state as compared to REM sleep. These studies reinforce the idea that a neuronal network rather than a single locus underlies a behavioral trait, which is also an outcome of the interaction among multiple neurotransmitter systems.

1.3.2 Cholinergic Processes and Anesthetic Mechanisms

A vast body of literature supports cholinergic generation of arousal states (Jones 2008; Lydic and Baghdoyan 2005). Cholinergic neurons in (i) LDT/PPT through efferents to intralaminar and midline thalamic nuclei, and (ii) BF through efferents to cortex, promote behavioral and electroencephalographic arousal (Jones 2008; Lydic and Baghdoyan 2005; Steriade and McCarley 2005). ACh levels in cortex, thalamus and mPRF are highest during waking and REM sleep, the states characterized by cortical activation (Jones 2008; Lydic and Baghdoyan 2005; Lydic et al. 1991; Steriade and McCarley 2005). Therefore, it is evident that ACh suppresses the high-voltage low-frequency EEG and the spindles associated with NREM sleep. Halothane decreases ACh release in mPRF (Keifer et al. 1994, 1996) and in addition causes EEG spindles that are similar to the spindles observed during NREM sleep (Keifer et al. 1994). Microinjection of cholinergic agonist carbachol into mPRF before halothane administration significantly reduced the number of EEG spindles (Keifer et al. 1996). Ketamine has also been shown to decrease ACh release in mPRF (Lydic and Baghdoyan 2002) whereas intraperitoneal propofol decreases the cortical and hippocampal ACh levels in a dose-dependent manner (Kikuchi et al. 1998). 192IgG-Saporin lesion of cholinergic neurons in BF, which should putatively decrease the cortical and hippocampal ACh levels, enhanced the potency of propofol anesthesia (Laalou et al. 2008). Infusion of nicotine into the centromedian thalamus, which receives afferents from LDT/PPT, restored mobility and righting in sevoflurane-anesthetized rats (Alkire et al. 2007).

Cholinergic involvement in anesthetic mechanisms is further demonstrated by a study showing that the dose required to induce loss of consciousness is increased following prior IV administration of a cholinesterase inhibitor, physostigmine (Fassoulaki et al. 1997). IV administration of physostigmine following propofol-induced anesthesia reversed the anesthetic-induced loss of consciousness (Meuret et al. 2000) and significantly reduced the recovery time following IV ketamine administration (Toro-Matos et al. 1980). The arousing effect of physostigmine could be reversed with the prior administration of scopolamine, a cholinergic antagonist

(Meuret et al. 2000). Physostigmine has also been shown to antagonize the hypnotic effects of sevoflurane (Plourde et al. 2003). Therefore, a decrease in the central cholinergic tone is conducive to the state of anesthesia.

1.3.3 Monoaminergic Processes and Anesthetic Mechanisms

Noradrenergic and histaminergic systems are causally and positively related to behavioral and EEG indices of arousal (Aston-Jones and Bloom 1981; Berridge and Foote 1996; Bovet et al. 1958; Lin 2000). The activity of histaminergic neurons has been shown to be linked to vigilance and the degree of alertness (Takahashi et al. 2006). Inhalational anesthetics hyperpolarize neurons in LC and DR (Sirois et al. 2000; Washburn et al. 2002). Infusion of an alpha-2 agonist, dexmedetomidine, into LC produces hypnosis that could be prevented through simultaneous infusion of alpha-2 antagonist atipamezole (Correa-Sales et al. 1992). The sedation produced by the action of dexmedetomidine on LC is through the disinhibition of VLPO neurons, which are thought to play an executive role in the generation of NREM sleep (Nelson et al. 2003). Activation of adrenergic alpha-1 receptors decreases whereas antagonism of alpha-1 receptors increases barbiturate anesthesia time (Mason and Angel 1983; Matsumoto et al. 1997). Pretreatment with a beta-adrenergic blocker also increased barbiturate anesthesia time in a dose-dependent manner (Mason and Angel 1983). Halothane decreased the histamine release in anterior hypothalamus, which is also reported to occur during sleep (Mammoto et al. 1997; Strecker et al. 2002). Intracerebroventricular (ICV) administration of histamine decreased pentobarbital-related hypnosis and hypothermia (Kalivas 1982). A recent study by Luo and Leung (2009) showed that the infusion of histamine into BF during isoflurane anesthesia in rats caused a decrease in burst suppression, which could be blocked by a prior infusion of H1 antagonist into BF. Further, histamine significantly reduced the time to recovery whereas H1 antagonist into BF significantly increased the time to recovery (Luo and Leung 2009). Collectively, these studies indicate that the activation and inactivation of monoaminergic nuclei, respectively, inhibit and enhance the efficacy of anesthetics.

1.3.4 Orexinergic Processes and Anesthetic Mechanisms

Orexinergic neurons in LH-perifornical area send dense projections to the arousal-related nuclei LC, DR, TMN, PPT and LDT (Peyron et al. 1998). ICV or local infusion of orexins into LC increases wakefulness (Bourgin et al. 2000). Interestingly, ICV application of orexin (i) decreased ketamine-induced noradrenaline release in medial prefrontal cortex, a target site of LC neurons (Tose et al. 2009), and (ii) reduced the time under anesthesia induced by ketamine (Tose et al. 2009) and barbiturates (Kushikata et al. 2003). Similar results have been reported with the use

of inhalational anesthesia. ICV orexin in isoflurane-anesthetized rats reduced burst suppression and produced EEG activation (Yasuda et al. 2003). Infusion of orexin-A into BF of isoflurane-anesthetized rats caused electroencephalographic arousal and a significant increase in the cortical ACh release (Dong et al. 2006). In sevoflurane-anesthetized rats, infusion of orexin-A into BF caused not only electroencephalographic arousal but also significantly decreased emergence time from anesthesia (Dong et al. 2009).

Orexinergic neurons in C57BL/6J mice show decreased c-fos expression, a marker for neural activity, under isoflurane and sevoflurane anesthesia (Kelz et al. 2008). Systemic administration of orexin-A antagonist delayed the emergence from the inhalational anesthesia (Kelz et al. 2008). Delayed emergence from sevoflurane and isoflurane was also observed in orexin/ataxin-3 narcoleptic mice, which have a deficient orexinergic system (Kelz et al. 2008). Studies from different laboratories have indicated the pre-eminence of orexin-A over orexin-B in the mediation of anesthetic effects (Dong et al. 2006, 2009; Kelz et al. 2008; Kushikata et al. 2003; Tose et al. 2009). Orexin-A directly depolarizes the PPT neurons (Kim et al. 2009), which innervate PRF (Reinoso-Suárez et al. 2001). Microdialysis delivery of orexin-A into PRF increases local ACh release (Bernard et al. 2003), whereas halothane and ketamine decrease the ACh release in PRF (Keifer et al. 1994, 1996; Lydic and Baghdoyan 2002). Therefore, it is evident that inactivation of orexinergic system is associated with the hypnotic component of general anesthesia. Furthermore, the orexinergic system interacts with noradrenergic and cholinergic systems to maintain arousal states and possibly emergence from certain anesthetics.

1.3.5 Adenosinergic Processes and Anesthetic Mechanisms

Adenosine, a purine nucleoside, is a product of serial dephosphorylation of adenosine triphosphate. Adenosine receptors are expressed in high concentration in brain, where adenosine acts as a neuromodulator through extracellular and intracellular signaling pathways (Dunwiddie and Masino 2001). A role for adenosine in neuroprotection, epilepsy, vasodilation, and analgesia has been demonstrated (Dunwiddie and Masino 2001). Adenosine has hypnogenic properties and has been shown to play a role in sleep-wake homeostasis (reviewed in McCarley 2007). Adenosine concentration in BF has been reported to increase during sleep deprivation (McCarley 2007). Systemic and ICV application of adenosine agonist in rat increases delta power and the changes produced in EEG power spectra were comparable to that observed after sleep deprivation (Benington et al. 1995). In addition to a role in the modulation of sleep-wake states, adenosine is also known to impact the effects of anesthetics. Sleep deprivation decreases the time to loss of righting reflex and increases post-anesthetic recovery time (Tung et al. 2002). However, pretreatment of sleep-deprived rats with systemic and/or local administration of adenosine antagonist into BF increased the time to loss of righting reflex and decreased the

post-anesthetic recovery time, demonstrating a role for adenosine in increased sensitivity to anesthetics after sleep deprivation (Tung et al. 2005). Intraperitoneal administration of adenosine shortened the induction time and enhanced the potency of thiopental, propofol and midazolam (Kaputlu et al. 1998). Perioperative administration of adenosine decreased the requirement for isoflurane anesthesia and postoperative analgesics (Segerdahl et al. 1995) whereas theophylline, an adenosine antagonist, partially reversed the effects of isoflurane in dogs as indicated by increased cerebral metabolic rate for oxygen and the appearance of higher frequencies in EEG (Roald et al. 1990). Dialysis delivery of adenosine A1 receptor agonist into mPRF of cats produced a significant delay in the post-halothane recovery and a decrease in the ACh release in mPRF (Tanase et al. 2003). The effect of adenosine agonist on post-halothane recovery period and ACh release in mPRF could be reversed with co-administration of an adenosine antagonist (Tanase et al. 2003). IV administration of adenosine caused significant reduction in minimum alveolar concentration (MAC) for halothane in dogs (Seitz et al. 1990). Although the effects of IV adenosine in dogs could be blocked by concurrent administration of the adenosine antagonist aminophylline (Seitz et al. 1990), aminophylline alone has not been shown to affect halothane MAC in dogs (Nicholls et al. 1986). Similar results were obtained in human volunteers in whom aminophylline administration alone did not affect desflurane MAC (Turan et al. 2010). However, in the same study it was reported that aminophylline increased the time to loss of consciousness and decreased the time to regain consciousness in human subjects anesthetized with propofol (Turan et al. 2010).

1.4 Functional Relationship of Sleep and Anesthesia

Both sleep and anesthesia are marked by a significant decrease in global cerebral metabolism and immobility. Further, the anesthetic state is a period of physiological and behavioral quiescence, which may provide a sleep-like experience. Tung and colleagues (2001b) found that prolonged IV administration of propofol in rats did not cause sleep rebound during the post-propofol recovery period, indicating that no sleep debt had accrued during the time under anesthesia. Under normal conditions, sleep deprivation is followed by a period of increased sleep or rebound in sleep, thereby compensating for the lost sleep time. Administration of propofol for 6 h in previously sleep-deprived rats demonstrated no difference in sleep during the post-anesthesia period as compared to natural recovery, thereby suggesting that the period under propofol anesthesia may serve a restorative purpose akin to sleep (Tung et al. 2004). In contrast to the propofol study (Tung et al. 2004), we recently showed that 4 h of isoflurane treatment following 24 h of selective REM sleep deprivation did not allow the recovery of REM sleep (Mashour et al. 2010). However, as has been reported earlier for total sleep deprivation (Tung et al. 2002), selective REM sleep restriction reduced the anesthetic requirement to achieve the same behavioral and electrophysiologic endpoint (Mashour et al. 2010). Thus, propofol allows the

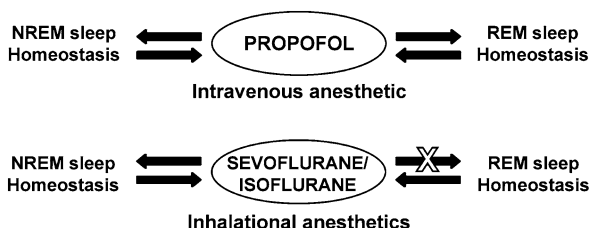

Fig. 1.1 Schematic showing the relationship between different anesthetics and sleep homeostasis. Propofol has a balanced reciprocal relationship with sleep homeostasis: it allows the recovery from sleep deprivation and sleep deprivation enhances its efficacy (Tung et al. 2004). Sevoflurane shows state-specific effects: it allows the recovery of NREM sleep but does not allow the recovery of REM sleep from total sleep deprivation (Pal et al. 2011). Like propofol, sleep deprivation enhances the potency of sevoflurane (Pal et al. 2011). Isoflurane does not allow the recovery of REM sleep from REM sleep deprivation while REM sleep deprivation enhances the efficacy of isoflurane (Mashour et al. 2010; Tung et al. 2004)

homeostatic recovery of both NREM and REM sleep, whereas isoflurane does not allow the recovery of REM sleep (Mashour et al. 2010; Tung et al. 2004).

However, in both studies (Mashour et al. 2010; Tung et al. 2004) the anesthetics were titrated to a level that allowed the continuous presence of high-voltage low-frequency waves as are observed during NREM sleep. Thus, it is not entirely possible to preclude the possibility of NREM sleep expression during anaesthesia. In order to overcome this confound, we conducted a recent study in which the effects of sevoflurane, titrated to approximately 50% burst suppression ratio, were investigated on sleep homeostasis (Pal et al. 2011). Rats were chronically instrumented and sleep-wake states were recorded under three conditions: (1) 36 h ad libitum sleep, (2) 12 h sleep deprivation followed by 24 h ad libitum sleep, and (3) 12 h sleep deprivation, followed by 6 h sevoflurane exposure, followed by 18 h ad libitum sleep. Sevoflurane exposure to sleep-deprived rats eliminated the homeostatic increase in NREM sleep and produced a significant decrease in the NREM sleep delta power during the post-anesthetic period, indicating a complete recovery from the effects of sleep deprivation. However, sevoflurane exposure did not affect the time course of REM sleep recovery. Therefore, unlike propofol, sevoflurane anaesthesia has differential effects on NREM and REM sleep homeostasis. Further, the effect of sevoflurane on REM sleep recovery is similar to that reported for isoflurane, thereby confirming the previous hypothesis that the relationship between sleep and anaesthesia is likely to be agent- and state-specific (Mashour et al. 2010). Consistent with the previous results from isoflurane and propofol studies (Mashour et al. 2010; Tung et al. 2002), sleep deprivation decreased the time to loss of righting reflex induced with sevoflurane (Pal et al. 2011). The relationship between these anesthetics and sleep homeostasis is summarized in Fig. 1.1. The study of sleep homeostasis and anaesthesia may provide a ‘composite picture’ of the effects of general anesthetics on sleep-wake systems. Agent- and state-specific differences may have clinical relevance in the perioperative care of surgical patients that have sleep disorders or that have been sleep deprived.

1.5 Conclusion

Sleep and anesthesia are distinct states that share important traits. The shared behavioral and electroencephalographic phenotypes of sleep and anesthesia likely relate to the neurochemical interfaces at subcortical arousal and sleep-promoting centers. It remains to be elucidated whether the induction of anesthesia is accomplished via the ‘bottom-up’ mechanisms of sleep, or through more direct cortical effects (Velly et al. 2007). Further study of sleep neurobiology will likely continue to be a fruitful line of investigation to better understand anesthetic mechanisms. Finally, the interfaces of sleep homeostasis and general anesthesia may be of increasing clinical importance, especially given the rising incidence of obstructive sleep apnea and other disorders that result in sleep deprivation.

Acknowledgements Supported by departmental and institutional funds.

References

- Abulafia R, Zalkind V, Devor M (2009) Cerebral activity during the anesthesia-like state induced by mesopontine microinjection of pentobarbital. *J Neurosci* 29(21):7053–7064
- Alkire MT, McReynolds JR, Hahn EL, Trivedi AN (2007) Thalamic microinjection of nicotine reverses sevoflurane-induced loss of righting reflex in the rat. *Anesthesiology* 107(2):264–272
- Aserinsky E, Kleitman N (1953) Regularly occurring periods of eye motility, and concomitant phenomena, during sleep. *Science* 118(3062):273–274
- Aston-Jones G, Bloom FE (1981) Activity of norepinephrine containing locus coeruleus neurons in behaving rats anticipates fluctuations in the sleep–waking cycle. *J Neurosci* 1(8):876–886
- Baghdoyan HA, Monaco AP, Rodrigo-Angulo ML, Assens F, McCarley RW, Hobson JA (1984) Microinjection of neostigmine into the pontine reticular formation of cats enhances desynchronized sleep signs. *J Pharmacol Exp Ther* 231(1):173–180
- Baghdoyan HA, Lydic R, Callaway CW, Hobson JA (1989) The carbachol-induced enhancement of desynchronized sleep signs is dose dependent and antagonized by centrally administered atropine. *Neuropsychopharmacology* 2(1):67–79
- Benington JH, Kodali SK, Heller HC (1995) Stimulation of $\alpha 1$ adenosine receptors mimics the electroencephalographic effects of sleep deprivation. *Brain Res* 692(1–2):79–85
- Bernard R, Lydic R, Baghdoyan HA (2003) Hypocretin-1 causes g protein activation and increases ac h release in rat pons. *Eur J Neurosci* 18(7):1775–1785
- Berridge CW, Foote SL (1996) Enhancement of behavioral and electroencephalographic indices of waking following stimulation of noradrenergic beta-receptors within the medial septal region of the basal forebrain. *J Neurosci* 16(21):6999–7009
- Blanco-Centurion C, Gerashchenko D, Shiromani PJ (2007) Effects of saporin-induced lesions of three arousal populations on daily levels of sleep and wake. *J Neurosci* 27(51):14,041–14,048
- Bourgin P, Escourrou P, Gaultier C, Adrien J (1995) Induction of rapid eye movement sleep by carbachol infusion into the pontine reticular formation in the rat. *Neuroreport* 6(3):532–536
- Bourgin P, Huitrón-Résendiz S, Spier AD, Fabre V, Morte B, Criado JR, Sutcliffe JG, Henriksen SJ, de Lecea L (2000) Hypocretin-1 modulates rapid eye movement sleep through activation of locus coeruleus neurons. *J Neurosci* 20(20):7760–7765
- Boveroux P, Bonhomme V, Boly M, Vanhauzenhuysse A, Maquet P, Laureys S (2008) Brain function in physiologically, pharmacologically, and pathologically altered states of consciousness. *Int Anesthesiol Clin* 46(3):131–146
- Bovet D, Kohn R, Marotta M, Silvestrini B (1958) Some effects of histamine in the normal and haemophilus pertussis vaccinated rat. *Br J Pharmacol Chemother* 13(1):74–83

- Capece ML, Baghdoyan HA, Lydic R (1999) New directions for the study of cholinergic REM sleep generation: Specify pre- and postsynaptic mechanisms. In: Mallick BN, Inoue S (eds) *Rapid eye movement sleep*. Narosa Publishing House, New Delhi
- Chu NS, Bloom FE (1974) Activity patterns of catecholamine-containing pontine neurons in the dorsolateral tegmentum of unrestrained cats. *J Neurobiol* 5(6):527–544
- Correa-Sales C, Rabin BC, Maze M (1992) A hypnotic response to dexmedetomidine, an alpha 2 agonist, is mediated in the locus coeruleus in rats. *Anesthesiology* 76(6):948–952
- Dang-Vu TT, Desseilles M, Petit D, Mazza S, Montplaisir J, Maquet P (2007) Neuroimaging in sleep medicine. *Sleep Medicine* 8(4):349–372
- Datta S, Siwek DF (1997) Excitation of the brain stem pedunculopontine tegmentum cholinergic cells induces wakefulness and REM sleep. *J Neurophysiol* 77(6):2975–2988
- Dement W (1958) The occurrence of low voltage, fast electroencephalogram patterns during behavioral sleep in the cat. *Electroencephalogr Clin Neurophysiol* 10(2):291–296
- Devor M, Zalkind V (2001) Reversible analgesia, atonia, and loss of consciousness on bilateral intracerebral microinjection of pentobarbital. *Pain* 94(1):101–112
- Dong HL, Fukuda S, Murata E, Zhu Z, Higuchi T (2006) Orexins increase cortical acetylcholine release and electroencephalographic activation through orexin-1 receptor in the rat basal forebrain during isoflurane anesthesia. *Anesthesiology* 104(5):1023–1032
- Dong H, Niu J, Su B, Zhu Z, Lv Y, Li Y, Xiong L (2009) Activation of orexin signal in basal forebrain facilitates the emergence from sevoflurane anesthesia in rat. *Neuropeptides* 43(3):179–185
- Dunwiddie TV, Masino SA (2001) The role and regulation of adenosine in the central nervous system. *Annu Rev Neurosci* 24:31–55
- Fassoulaki A, Sarantopoulos C, Derveniotis C (1997) Physostigmine increases the dose of propofol required to induce anaesthesia. *Can J Anaesth* 44(11):1148–1151
- Ferenets R, Lipping T, Suominen P, Turunen J, Puumala P, Jantti V, Himanen SL, Huotari AM (2006) Comparison of the properties of EEG spindles in sleep and propofol anesthesia. *Conf Proc IEEE Eng Med Biol Soc* 1:6356–6359
- Franks NP (2008) General anaesthesia: from molecular targets to neuronal pathways of sleep and arousal. *Nat Rev Neurosci* 9(5):370–385
- Gervasoni D, Darracq L, Fort P, Souliere F, Chouvet G, Luppi PH (1998) Electro-physiological evidence that noradrenergic neurons of the rat locus coeruleus are tonically inhibited by GABA during sleep. *Eur J Neurosci* 10(3):964–970
- Gottesmann C (2001) The golden age of rapid eye movement sleep discoveries. 1. lucretius-1964. *Prog Neurobiol* 65(3):211–287
- Gottesmann C, Gandolfo G, Arnau C, Gauthier P (1998) The intermediate stage and paradoxical sleep in the rat: influence of three generations of hypnotics. *Eur J Neurosci* 10(2):409–414
- Goutagny R, Luppi PH, Salvat D, Lapray D, Gervasoni D, Fort P (2008) Role of the dorsal paraventricular reticular nucleus in paradoxical (rapid eye movement) sleep generation: a combined electrophysiological and anatomical study in the rat. *Neuroscience* 152(3):849–857
- Hassani OK, Lee MG, Jones BE (2009) Melanin-concentrating hormone neurons discharge in a reciprocal manner to orexin neurons across the sleep–wake cycle. *Proc Natl Acad Sci USA* 106(7):2418–2422
- Hassani OK, Henry P, Lee MG, Jones BE (2010) GABAergic neurons intermingled with orexin and mch neurons in the lateral hypothalamus discharge maximally during sleep. *Eur J Neurosci* 32(3):448–457
- Hobson JA, McCarley RW, Wyzinski PW (1975) Sleep cycle oscillation: reciprocal discharge by two brain stem neuronal groups. *Science* 189(4196):55–58
- Jones BE (2008) Modulation of cortical activation and behavioral arousal by cholinergic and orexinergic systems. *Ann NY Acad Sci* 1129:1129–1134
- Jouvet M (1962) Recherches sur les structures nerveuses et les mecanismes responsables des differentes phases du sommeil physiologique. *Arch Ital Biol* 100:125–206
- Jouvet M (2004) How sleep was dissociated into two states: telencephalic and rhombencephalic sleep? *Arch Ital Biol* 142(4):317–326

- Jouvet M, Michel F, Courjon J (1959) Electric activity of the rhinencephalon during sleep in cats. *Comptes Rendus Séances Soc Biol Fil* 153(1):101–105
- Kalivas PW (1982) Histamine-induced arousal in the conscious and pentobarbital-pretreated rat. *J Pharmacol Exp Ther* 222(1):37–42
- Kaputlu I, Sadan G, Ozdem S (1998) Exogenous adenosine potentiates hypnosis induced by intravenous anaesthetics. *Anesthesia* 53(5):496–500
- Kaur S, Saxena RN, Mallick BN (2001) GABAergic neurons in prepositus hypoglossi regulate REM sleep by its action on locus coeruleus in freely moving rats. *Synapse* 42(3):141–150
- Keifer JC, Baghdoyan HA, Becker L, Lydic R (1994) Halothane decreases pontine acetylcholine release and increases EEG spindles. *Neuroreport* 5(5):577–580
- Keifer JC, Baghdoyan HA, Lydic R (1996) Pontine cholinergic mechanisms modulate the cortical electroencephalographic spindles of halothane anesthesia. *Anesthesiology* 84(4):945–954
- Kelz MB, Sun Y, Chen J, Meng QC, Moore JT, Veasey SC, Dixon S, Thornton M, Funato H, Yanagisawa M (2008) An essential role for orexins in emergence from general anesthesia. *Proc Natl Acad Sci USA* 105(4):1309–1314
- Kikuchi T, Wang Y, Sato K, Okumura F (1998) In vivo effects of propofol on acetylcholine release from the frontal cortex, hippocampus and striatum studied by intracerebral microdialysis in freely moving rats. *Br J Anaesth* 80(5):644–648
- Kim J, Nakajima K, Oomura Y, Wayner MJ, Sasaki K (2009) Electrophysiological effects of orexins/hypocretins on pedunculopontine tegmental neurons in rats: an in vitro study. *Peptides* 30(2):191–209
- Kushikata T, Hirota K, Yoshida H, Kudo M, Lambert DG, Smart D, Jerman JC, Matsuki A (2003) Orexinergic neurons and barbiturate anesthesia. *Neuroscience* 121(4):855–863
- Laalou FZ, de Vasconcelos AP, Oberling P, Jeltsch H, Cassel JC, Pain L (2008) Involvement of the basal cholinergic forebrain in the mediation of general (propofol) anesthesia. *Anesthesiology* 108(5):888–896
- Lin JS (2000) Brain structures and mechanisms involved in the control of cortical activation and wakefulness, with emphasis on the posterior hypothalamus and histaminergic neurons. *Sleep Med Rev* 4(5):471–503
- Lindsley DB, Bowden J, Magoun HW (1949) Effect upon the EEG of acute injury to the brain stem activating system. *Electroencephalogr Clin Neurophysiol* 1(4):475–486
- Lu J, Bjorkum AA, Xu M, Gaus SE, Shiromani PJ, Saper CB (2002) Selective activation of the extended ventrolateral preoptic nucleus during rapid eye movement sleep. *J Neurosci* 22(11):4568–4576
- Lu JW, Fenik VB, Branconi JL, Rukhadze I, Mann GL, Kubin L (2007) Disinhibition of perifornical hypothalamic neurones activates noradrenergic neurones and blocks pontine carbachol-induced REM sleep-like episodes in rats. *J Physiol* 582(2):553–567
- Luo T, Leung LS (2009) Basal forebrain histaminergic transmission modulates electroencephalographic activity and emergence from isoflurane anesthesia. *Anesthesiology* 111(4):725–733
- Lydic R, Baghdoyan HA (1993) Pedunculopontine stimulation alters respiration and increases ach release in the pontine reticular formation. *Am J Physiol* 264:R544–554
- Lydic R, Baghdoyan HA (2002) Ketamine and mk-801 decrease acetylcholine release in the pontine reticular formation, slow breathing, and disrupt sleep. *Sleep* 25(6):617–622
- Lydic R, Baghdoyan HA (2005) Sleep, anesthesiology, and the neurobiology of arousal state control. *Anesthesiology* 103(6):1268–1295
- Lydic R, Biebuyck JF (1994) Sleep neurobiology: relevance for mechanistic studies of anaesthesia. *Br J Anaesth* 72(5):506–508
- Lydic R, McCarley RW, Hobson JA (1987) Serotonin neurons and sleep. I long term recordings of dorsal raphe discharge frequency and pgo waves. *Arch Ital Biol* 125(4):317–343
- Lydic R, Baghdoyan HA, Lorinc Z (1991) Microdialysis of cat pons reveals enhanced acetylcholine release during state-dependent respiratory depression. *Am J Physiol* 261:R766–770
- Ma J, Shen B, Stewart LS, Herrick IA, Leung LS (2002) The septohippocampal system participates in general anesthesia. *J Neurosci* 22(2):RC200
- Magnes J, Moruzzi G, Pompeiano O (1961) Synchronization of EEG produced by low-frequency electrical stimulation of the region of the solitary tract. *Arch Ital Biol* 99:33–67

- Magni F, Moruzzi G, Rossi CF, Zanchetti A (1959) EEG arousal following inactivation of the lower brain stem by selective injection of barbiturate into the vertebral circulation. *Arch Ital Biol* 923:33–46
- Mallick BN, Chhina GS, Sundaram KR, Singh B, Kumar VM (1983) Activity of preoptic neurons during synchronization and desynchronization. *Exp Neurol* 81(3):586–597
- Mallick BN, Kaur S, Saxena RN (2001) Interactions between cholinergic and GABAergic neurotransmitters in and around the locus coeruleus for the induction and maintenance of rapid eye movement sleep in rats. *Neuroscience* 104(2):467–485
- Mallick BN, Thankachan S, Islam F (2004) Influence of hypnogenic brain areas on wakefulness- and rapid-eye-movement sleep-related neurons in the brainstem of freely moving cats. *J Neurosci Res* 75(1):133–142
- Maloney KJ, Mainville L, Jones BE (1999) Differential c-fos expression in cholinergic, monoaminergic, and GABAergic cell groups of the pontomesencephalic tegmentum after paradoxical sleep deprivation and recovery. *J Neurosci* 19(8):3057–3072
- Mammoto T, Yamamoto Y, Kagawa K, Hayashi Y, Mashimo T, Yoshiya I, Yamatodani A (1997) Interactions between neuronal histamine and halothane anesthesia in rats. *J Neurochem* 69(1):406–411
- Manohar S, Noda H, Adey WR (1972) Behavior of mesencephalic reticular neurons in sleep and wakefulness. *Exp Neurol* 34(1):140–157
- Mashour GA, Lipinski W, Matlen L, Walker AJ, Turner A, Schoen W, Lee U, Poe GR (2010) Isoflurane anesthesia does not satisfy the homeostatic need for rapid eye movement sleep. *Anesth Analg* 110(5):1283–1289
- Mason ST, Angel A (1983) Anaesthesia: the role of adrenergic mechanisms. *Eur J Pharmacol* 91(1):29–39
- Matsumoto K, Kohno SI, Ojima K, Watanabe H (1997) Flumazenil but not FG7142 reverses the decrease in pentobarbital sleep caused by activation of central noradrenergic systems in mice. *Brain Res* 754(1–2):325–328
- McCarley RW (2007) Neurobiology of REM and NREM sleep. *Sleep Medicine* 8(4):302–330
- McGinty DJ, Harper RM (1976) Dorsal raphe neurons: Depression of firing during sleep in cats. *Brain Res* 101(3):569–575
- Mendelson WB (1996) Sleep induction by microinjection of pentobarbital into the medial preoptic area in rats. *Life Sci* 59(22):1821–1828
- Mendelson WB, Martin JV (1992) Characterization of the hypnotic effects of triazolam microinjections into the medial preoptic area. *Life Sci* 50(15):1117–1128
- Meuret P, Backman SB, Bonhomme V, Plourde G, Fiset P (2000) Physostigmine reverses propofol-induced unconsciousness and attenuation of the auditory steady state response and bispectral index in human volunteers. *Anesthesiology* 93(3):708–717
- Mignot E (2008) Why we sleep: the temporal organization of recovery. *PLoS Biol* 6(4):e106
- Moruzzi G, Magoun HW (1949) Brainstem reticular formation and activation of the EEG. *Electroencephalogr Clin Neurophysiol* 1(4):455–473
- Nelson LE, Guo TZ, Lu J, Saper CB, Franks NP, Maze M (2002) The sedative component of anesthesia is mediated by GABA(A) receptors in an endogenous sleep pathway. *Nat Neurosci* 5(10):979–984
- Nelson LE, Lu J, Guo T, Saper CB, Franks NP, Maze M (2003) The alpha2-adrenoceptor agonist dexmedetomidine converges on an endogenous sleep-promoting pathway to exert its sedative effects. *Anesthesiology* 98(2):428–436
- Nicholls EA, Louie GL, Prokocimer PG, Maze M (1986) Halothane anesthetic requirements are not affected by aminophylline treatment in rats and dogs. *Anesthesiology* 65(6):637–641
- Nitz D, Siegel JM (1997) GABA release in the locus coeruleus as a function of the sleep/wake state. *Neuroscience* 78(3):795–801
- Pace-Schott EF, Hobson JA (2002) The neurobiology of sleep: genetics, cellular physiology and subcortical networks. *Nat Rev Neurosci* 3(8):591–605
- Pal D, Mallick BN (2004) GABA in pedunculo pontine tegmentum regulates spontaneous rapid eye movement sleep by acting on GABAA receptors in freely moving rats. *Neurosci Lett* 365(3):200–204

- Pal D, Mallick BN (2006) Role of noradrenergic and GABAergic inputs in pedunculopontine tegmentum for regulation of rapid eye movement sleep in rats. *Neuropharmacology* 51(1):1–11
- Pal D, Mallick BN (2009) GABA in pedunculopontine tegmentum increases rapid eye movement sleep in freely moving rats: possible role of GABAergic inputs from substantia nigra pars reticulata. *Neuroscience* 164(2):404–414
- Pal D, Mallick BN (2010) GABA-ergic modulation of pontine cholinergic and noradrenergic neurons for rapid eye movement sleep generation. In: Monti JM, Pandiperumal SR, Mohler H (eds) *GABA and sleep: molecular, functional and clinical aspects*. Springer, Basel AG
- Pal D, Lipinski WJ, Walker AJ, Turner AM, Mashour GA (2011) State-specific effects of sevoflurane anesthesia on sleep homeostasis: Selective recovery of slow wave but not rapid eye movement sleep. *Anesthesiology* 114(2):302–310
- Peyron C, Tighe DK, van den Pol AN, de Lecea L, Heller HC, Sutcliffe JG, Kilduff TS (1998) Neurons containing hypocretin (orexin) project to multiple neuronal systems. *J Neurosci* 18(23):9996–10,015
- Plourde G, Chartrand D, Fiset P, Font S, Backman SB (2003) Antagonism of sevoflurane anesthesia by physostigmine: effects on the auditory steady-state response and bispectral index. *Br J Anaesth* 91(4):583–586
- Rechtschaffen A, Siegel JM (2000) Sleep and dreaming. In: Kandell E, Schwartz JH, Jessell T (eds) *Principles of neural science*. McGraw-Hill, New York
- Reinoso-Barbero F, de Andres I (1995) Effects of opioid microinjections in the nucleus of the solitary tract on the sleep–wakefulness cycle states in cats. *Anesthesiology* 82(1):144–152
- Reinoso-Suárez F, de Andres I, Rodrigo-Angulo ML, Garzón M (2001) Brain structures and mechanisms involved in the generation of REM sleep. *Sleep Med Rev* 5(1):63–77
- Roald OK, Forsman M, Steen PA (1990) Partial reversal of the cerebral effects of isoflurane in the dog by theophylline. *Acta Anaesthesiol Scand* 34(7):548–551
- Sastre JP, Buda C, Kitahama K, Jouvet M (1996) Importance of the ventrolateral region of the periaqueductal gray and adjacent tegmentum in the control of paradoxical sleep as studied by muscimol microinjections in the cat. *Neuroscience* 74(2):415–426
- Segerdahl M, Ekblom A, Sandelin K, Wickman M, Sollevi A (1995) Perioperative adenosine infusion reduces the requirements for isoflurane and postoperative analgesics. *Anesth Analg* 80(6):1145–1149
- Seitz PA, ter Riet M, Rush W, Merrell WJ (1990) Adenosine decreases the minimum alveolar concentration of halothane in dogs. *Anesthesiology* 73(5):990–994
- Siegel JM (2008) Do all animals sleep? *Trends Neurosci* 31(4):208–213
- Siegel JM, Nienhuis R, Tomaszewski KS (1984) REM sleep signs rostral to chronic transections at the pontomedullary junction. *Neurosci Lett* 45(3):241–246
- Singh S, Mallick BN (1996) Mild electrical stimulation of pontine tegmentum around locus coeruleus reduces rapid eye movement sleep in rats. *Neurosci Res* 24(3):227–235
- Sirois JE, Lei Q, Talley EM, Lynch 3rd C, Bayliss DA (2000) The TASK-1 two-pore domain K^+ channel is a molecular substrate for neuronal effects of inhalation anesthetics. *J Neurosci* 20(17):6347–6354
- Steriade M, McCarley RW (2005) *Brain stem control of wakefulness and sleep*, 2nd edn. Plenum, New York
- Strecker R, Nalwalk J, Dauphin LJ, Thakkar MM, Chen Y, Ramesh V, Hough LB, McCarley RW (2002) Extracellular histamine levels in the feline preoptic/anterior hypothalamic area during natural sleep–wakefulness and prolonged wakefulness: an in vivo microdialysis study. *Neuroscience* 113(3):663–670
- Szymusiak R, Gvilia I, McGinty D (2007) Hypothalamic control of sleep. *Sleep Medicine* 8(4):291–301
- Takahashi K, Lin JS, Sakai K (2006) Neuronal activity of histaminergic tuberomammillary neurons during wake-sleep states in the mouse. *J Neurosci* 26(40):10,292–10,298
- Tanase D, Baghdoyan HA, Lydic R (2003) Dialysis delivery of an adenosine A1 receptor agonist to the pontine reticular formation decreases acetylcholine release and increases anesthesia recovery time. *Anesthesiology* 98(4):912–920

- Thakkar M, Portas C, McCarley RW (1996) Chronic low-amplitude electrical stimulation of the laterodorsal tegmental nucleus of freely moving cats increases REM sleep. *Brain Res* 723(1–2):223–227
- Thakkar MM, Strecker RE, McCarley RW (1998) Behavioral state control through differential serotonergic inhibition in the mesopontine cholinergic nuclei: a simultaneous unit recording and microdialysis study. *J Neurosci* 18(14):5490–5497
- Thankachan S, Islam F, Mallick BN (2001) Role of wake inducing brain stem area on rapid eye movement sleep regulation in freely moving cats. *Brain Res Bull* 55(1):43–49
- Toro-Matos A, Rendon-Platas AM, Avila-Valdez E, Villarreal-Guzman RA (1980) Physostigmine antagonizes ketamine. *Anesth Analg* 59(10):764–767
- Tortorolo P, Morales FH, Chase MH (2002) GABAergic mechanisms in the pedunculopontine tegmental nucleus of the cat promote active (REM) sleep. *Brain Res* 944(1–2):1–9
- Tose R, Kushikata T, Yoshida H, Kudo M, Furukawa K, Ueno S, Hirota K (2009) Orexin decreases ketamine-induced anesthesia time in the rat: the relevance to brain noradrenergic neuronal activity. *Anesth Analg* 108(2):491–495
- Triarhou LC (2006) The percipient observations of Constantin von Economo on encephalitis lethargica and sleep disruption and their lasting impact on contemporary sleep research. *Brain Res Bull* 69(3):244–258
- Tung A, Mendelson WB (2004) Anesthesia and sleep. *Sleep Med Rev* 8(3):213–225
- Tung A, Bluhm B, Mendelson WB (2001a) The hypnotic effect of propofol in the medial preoptic area of the rat. *Life Sci* 69(7):855–862
- Tung A, Lynch JP, Mendelson WB (2001b) Prolonged sedation with propofol in the rat does not result in sleep deprivation. *Anesth Analg* 92(5):1232–1236
- Tung A, Szafran MJ, Bluhm B, Mendelson WB (2002) Sleep deprivation potentiates the onset and duration of loss of righting reflex induced by propofol and isoflurane. *Anesthesiology* 94(4):906–911
- Tung A, Bergmann BM, Herrera S, Cao D, Mendelson WB (2004) Recovery from sleep deprivation occurs during propofol anesthesia. *Anesthesiology* 100(6):1419–1426
- Tung A, Herrera S, Szafran MJ, Kasza K, Mendelson WB (2005) Effect of sleep deprivation on righting reflex in the rat is partially reversed by administration of adenosine A1 and A2 receptor antagonists. *Anesthesiology* 102(6):1158–1164
- Turan A, Kasuya Y, Govinda R, Obal D, Rauch S, Dalton JE, Akca O, Sessler DI (2010) The effect of aminophylline on loss of consciousness, bispectral index, propofol requirement, and minimum alveolar concentration of desflurane in volunteers. *Anesth Analg* 110(2):449–454
- Vanni-Mercier G, Sakai K, Lin JS, Jouvett M (1989) Mapping of cholinergic brainstem structures responsible for the generation of paradoxical sleep in the cat. *Arch Ital Biol* 127(3):133–164
- Vanini G, Tortorolo P, McGregor R, Chase MH, Morales FR (2007) GABAergic processes in the mesencephalic tegmentum modulate the occurrence of active (rapid eye movement) sleep in guinea pigs. *Neuroscience* 145(3):1157–1167
- Vanini G, Watson CJ, Lydic R, Baghdoyan HA (2008) Gamma-aminobutyric acid-mediated neurotransmission in the pontine reticular formation modulates hypnosis, immobility, and breathing during isoflurane anesthesia. *Anesthesiology* 109(6):978–988
- Vanini G, Wathen BL, Lydic R, Baghdoyan HA (2011) Endogenous GABA levels in pontine reticular formation are greater during wakefulness than during rapid eye movement sleep. *J Neurosci* 31(7):2649–2656
- Vazquez J, Baghdoyan HA (2004) GABA receptors inhibit acetylcholine release in cat pontine reticular formation: Implications for REM sleep regulation. *J Neurophysiol* 92(4):2198–2206
- Velly LJ, Rey MF, Bruder NJ, Gouvitsos FA, Witjas T, Regis JM, Peragut JC, Gouin FM (2007) Differential dynamic of action on cortical and subcortical structures of anesthetic agents during induction of anesthesia. *Anesthesiology* 107(2):202–212
- Vertes RP (1977) Selective firing of rat pontine gigantocellular neurons during movement and REM sleep. *Brain Res* 128(1):146–152
- Villablanca JR (2004) Counterpointing the functional role of the forebrain and of the brainstem in the control of the sleep–waking system. *J Sleep Res* 13(3):179–208

- Washburn CP, Sirois JE, Talley EM, Guyenet PG, Bayliss DA (2002) Serotonergic raphe neurons express TASK channel transcripts and a TASK-like pH- and halothane-sensitive K⁺ conductance. *J Neurosci* 22(4):1256–1265
- Xi MC, Morales FR, Chase MH (1999) Evidence that wakefulness and REM sleep are controlled by a GABAergic pontine mechanism. *J Neurophysiol* 82(4):2015–2019
- Xi MC, Morales FR, Chase MH (2001) Effects on sleep and wakefulness of the injection of hypocretin-1 (orexin-A) into the laterodorsal tegmental nucleus of the cat. *Brain Res* 901(1–2):259–264
- Yasuda Y, Takeda A, Fukuda S, Suzuki H, Ishimoto M, Mori Y, Eguchi H, Saitoh R, Fujihara H, Honda K, Higuchi T (2003) Orexin elicits arousal electroencephalography without sympathetic cardiovascular activation in isoflurane-anesthetized rats. *Anesth Analg* 97(6):1663–1666
- Zimmerman JE, Naidoo N, Raizen DM, Pack AI (2008) Conservation of sleep: insights from non-mammalian model systems. *Trends Neurosci* 31(7):371–376

Chapter 2

Modelling Sleep and General Anaesthesia

J.W. Sleigh, L. Voss, M.L. Steyn-Ross, D.A. Steyn-Ross, and M.T. Wilson

2.1 Introduction

There is active controversy concerning the ideas about the relationship between the states of natural sleep and general anaesthesia (Hudetz 2008; Lu et al. 2008; Zecharia et al. 2009). Because, by definition, general anaesthetic drugs act to diminish the conscious state of the central nervous system—they are said to bias the central nervous system to enter natural sleep-like modes of operation (Franks 2008; Lancel 1999; Lin et al. 1989). This is manifest in the many similarities between the electroencephalogram (EEG) of natural sleep and the EEG when the patient is receiving modest doses of general anaesthetic. Further evidence to support this idea is found in a number of studies in which a sedated state may be induced (or reversed) by microinjection of various anaesthetic (and anti-anaesthetic) substances into some discrete areas of the brain-stem and midbrain which have been shown to be critical in the co-ordination of natural sleep-wake transitions (Hudetz et al. 2003; Nelson et al. 2002; Alkire et al. 2007, 2009; Sukhotinsky et al. 2007). These sub-cortical arousal structures facilitate wakefulness by providing ongoing depolarizing neuromodulatory input to the cortex. It is hard to imagine a more evolutionarily important behavior for an animal than the ability to achieve the state of wakefulness. Therefore, it is not surprising that there exist many overlapping brain-stem systems that can activate the cerebral cortex—acting via a number of different chemical substances such as glutamate, acetylcholine, amines, and orexin. Presumably this huge redundancy makes the animal relatively insensitive to natural neuromodulator toxins. However, there is a problem. The sleep state seems, also, to be essential for the survival of animals with adaptive nervous systems. Therefore,

J.W. Sleigh (✉)

Department of Anaesthesia, Waikato Clinical School, University of Auckland, Hamilton, New Zealand

e-mail: sleighj@waikatodhb.govt.nz

in tandem with the robust systems required to maintain wakefulness, the animal must also be able to reliably achieve sleep. In mammals the ability to be ‘properly awake’ or ‘properly asleep’ seems to have been achieved by the evolutionary development of neuronal mechanisms that interact over a variety of different scales of size. If we want to model the processes of sleep and anaesthesia, the challenge is to include the processes that are occurring at many different spatial scales. The global behavioral states of wakefulness and sleep reflect large-scale alterations in activity encompassing virtually the entire cerebral cortex. At the scale of traditional anatomic ‘brain-centers’ (millimetre-to-centimetre size) we could envisage the cerebral cortex as being strongly influenced by distant brain-stem servo-controlling systems based on mutual inhibition. These models typically have sets of equations that hope to capture the dynamics of the interacting groups of brain-stem neurons (Behn et al. 2007; Rempe et al. 2010; Fulcher et al. 2008; Phillips and Robinson 2008); and thus replicate observed activity in various wake-ON, sleep-ON, wake-OFF, and sleep-OFF neuronal populations (Leung and Mason 1999; Lin et al. 1988; Saint-Mleux et al. 2004; Saito et al. 1977). However, the complexity of the thalamo-cortical response to the brain-stem neuromodulator input cannot be ignored; and should be included in the modelling process. At the smaller cellular and molecular scale (sub-millimeter), there is also a strong tendency for thalamo-cortical neuronal populations to abruptly jump between active and silent modes of operation—without externally derived driving. This bistability is probably driven by both intrinsic neuronal ion currents, and synaptic effects (Fuentelba et al. 2005; Hill and Tononi 2005; Compte et al. 2003; Contreras et al. 1996; Steriade et al. 2001; Steriade and Amzica 1998). The modelling of sleep has thus developed in two somewhat divergent directions, reflecting these diversity of scales. On one hand are the ideas that the brain-stem control is pre-eminent, and the cortical responses are just subservient to the brain-stem neuromodulator outputs (Clearwater et al. 2008; Phillips and Robinson 2008). The opposing body of work, does not look at how the neuromodulator milieu is generated, but assumes that it is simply an externally imposed parameter; and instead looks in great detail at the cortical (and sometimes thalamic) responses to the change in neuromodulator environment (Wilson et al. 2005, 2006). As yet there does not seem to be a single comprehensive model of both brain-stem and neocortical interactions. The diagram in Fig. 2.1 summarizes the components that would be included in such a model.

At higher concentrations of anaesthetic drugs, the similarities between general anaesthesia and natural sleep are less obvious. In particular, the ability for painful (nociceptive) stimuli to activate awakening is markedly suppressed by general anaesthetic drugs. With further increases in anaesthetic dosage, the EEG tends toward a burst-suppression pattern—which is not found in natural sleep states; and the animal becomes behaviorally impervious to all nociceptive arousal. It is unclear exactly how general anaesthetic drugs cause this suppression of responsiveness in the animal. In this chapter we will address this question using a neocortical mean-field model. We explicitly concentrate on modelling cerebro-cortical dynamics. Brain-stem neuromodulation is limited to exogenously imposed variations in cortical neuronal resting membrane potential, with no attempt to quantify the complex multimodal brain-stem feedback mechanisms. With this cortico-centric model

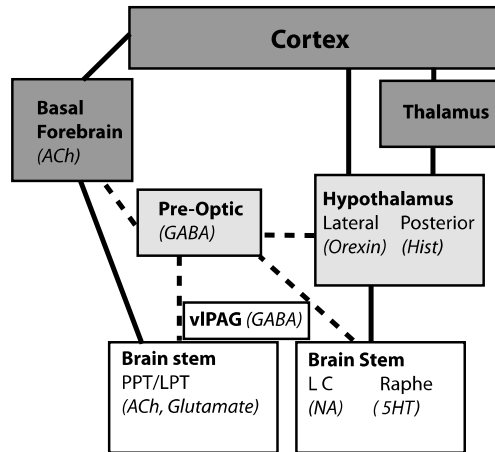

Fig. 2.1 Diagram of various components of sleep processes in the brain. For clarity the circadian and limbic inputs have not been included. The *non-italic lettering* indicates the various anatomical brain regions and nuclei (vIPAG = ventro-lateral peri-aqueductal gray matter, PPT = pedunculo-pontine-tegmentum, LPT = lateral pontine tegmentum, LC = locus ceruleus). The *black lines* indicate excitatory interactions, and the *dashed lines* indicate inhibitory interactions. The *italic lettering* indicates the various neuromodulators (ACh = acetylcholine, Hist = histamine, NA = Noradrenaline, 5HT = serotonin, GABA = gamma-amino-butyric acid)

we propose that the gamma-amino-butyric-acid (GABA)-ergic effect of common general anaesthetic drugs is a sufficient explanation of both:

1. the ability of general anaesthetic drugs to precipitate the central nervous system into a sleep-like state, and is also
2. the mechanism by which general anaesthetic drugs obtund nociceptive arousal.

2.2 Mechanisms of Natural Sleep

Sleep is a phenomenon that is ubiquitous in the animal kingdom. It is essential for survival; even though—from a superficial evolutionary viewpoint—the act of becoming unresponsive to the outside world for a considerable period each day would not appear to be very advantageous. The investigation of the control mechanisms in mammalian sleep has been very intense in recent years and we would refer the reader to a number of excellent reviews (Rosenwasser 2009; McCarley 2007; McCarley and Chokroverty 2007; Saper et al. 2005; Fuller et al. 2006, 2007), and also the Chap. 1 in this volume. In brief, there is an interlinked system of mutually inhibitory neuronal populations—located in the brain stem and basal forebrain—that will tend to cause the state of the animal to be either awake or asleep. This has been described as being analogous to a ‘flip-flop’ electrical circuit. These neuronal populations are made up of relatively few cells (perhaps only a few thousand), but

have a very wide projection, and so are able to influence huge areas of the neocortex. The systems are set up so that an intermediate state is not inherently stable—the animal does not remain in a half-asleep state.

Traditionally sleep has been described as being under the control of two processes: (i) homeostatic and (ii) circadian. Sleep is then further classified into rapid-eye-movement (REM) or paradoxical sleep; and non-REM (NREM) or slow-wave sleep states. REM sleep is associated with relatively high levels of activity in cholinergic and glutamatergic neurons, whereas NREM sleep is predominantly a GABAergic state (Fuller et al. 2007; Goutagny et al. 2008; Luppí et al. 2006). The amount of sleep varies widely between different species of mammals. A mathematical model of the brain-stem control of circadian and ultradian sleep rhythms of V. Booth et al. can be found in Chap. 5. The various states of sleep and wakefulness have been defined mainly by using stereotypical heuristic EEG patterns. These changes in EEG pattern are usually quite clear. Questions arise as to what is the real biological significance to the animal of these EEG changes, and also how they can be quantified. An accurate mathematically based model of sleep would go a long way toward answering both these questions.

There is increasing evidence that ‘sleep’ is a phenomenon that can occur in quite small localized populations of neurons (Krueger et al. 2008). As a homeostatic response to periods of prolonged neuronal activity, neurons show a propensity to enter a state where they undergo fluctuations of hyperpolarized quiescence and depolarized activity that are indistinguishable from those seen in classical slow-wave sleep. The reason for this phenomenon is not known with certainty, but probably involves some synaptic re-organization which is required for more efficient information handling (Tononi 2009; Tononi and Cirelli 2006; Vyazovskiy et al. 2008). This process has been modeled (Roy et al. 2008; Riedner et al. 2007). There is therefore a tension between the requirements for local populations of neurons to engage in a period of sleep for their efficient operation, and the requirements for the whole mammal to function as safely as possible in a dangerous world. The solution appears to be utilization of the primitive brain-stem systems as controllers of mammalian sleep. The process of falling asleep involves the interaction of many large-scale brain systems. It can be easily imagined that the roles of these systems are to:

- Minimize the tendency for small parts of the brain to fall asleep, while the rest of the brain is awake. In aquatic mammals half the brain sleeps at any one time. Presumably this occurs because some responsiveness is required for the continued swimming and breathing necessary for survival in dolphins and whales (Siegel 2009). In land mammals, it seems that there is a preference for the whole brain to sleep synchronously. This is probably because higher forms of mammalian consciousness require co-ordination and synchrony within neuronal assemblies that span widely separated parts of the brain (Harris 2005; Massimini et al. 2009). Thus the maintenance of function within these spatially disparate assemblies would require that these large portions of the brain enter the sleep state at the same time. This requirement for total-brain sleep would suggest that localized unsynchronized sleep episodes are not sufficient for the large-scale

synaptic re-modelling required for effective mammalian cognition. Also spatially synchronous EEG activity is a notable feature of slow-wave sleep (Destexhe et al. 1999).

- Co-ordinate the sleep phase with the part of the day that the animal is least active. Thus predominantly visual animals (like man) tend to sleep at night, and predominantly smell-oriented animals (like rats) tend to sleep in the day.

2.2.1 The Neurobiology of Falling Asleep and Waking up

The sensation of sleepiness can arise from at least two sources; (1) either directly from circadian inputs (the suprachiasmatic nucleus of the hypothalamus (Fuller et al. 2006; Saper et al. 2005)), or (2) from other less well-specified, homeostatically derived, neuromodulator somnogens (such as adenosine) (Krueger 2008; Basheer et al. 2007; Arrigoni et al. 2006). These chemicals can be generated as the result of prolonged neuronal activity, or from other pathological origins—such as is found in the drowsiness of septic encephalopathy. In the awake state, the gamma-amino-butyric-acid(GABA)-ergic neurons of the ventro-lateral preoptic nucleus (VLPO) of the hypothalamus (Winsky-Sommerer 2009) are suppressed by many excitatory arousal substances (amines, glutamate, acetylcholine, orexin). If the somnogen levels—or the suprachiasmatic circadian input—are sufficient to reduce the effect of these arousal neuromodulators, the sleep-active GABAergic neurons in the VLPO become active and these cells then further suppress the activity in the excitatory arousal systems. Thus a positive feedback is set up leading to rapid and almost complete suppression of activity in the arousal systems (Lin et al. 1988; Luppi et al. 2004; Moreno-Balandran et al. 2008; Ohno and Sakurai 2008; Saito et al. 1977; Verret et al. 2006; Villablanca 2004). Removal of the tonic neuromodulator-induced depolarization of the cortico-thalamic circuits allows these circuits to enter hyperpolarized silent ‘DOWN’ states that are characteristic of slow-wave, or NREM sleep (Steriade et al. 2001). The EEG signature of these modes of operation are sleep spindles, delta waves, and the slow oscillation (Steriade and Amzica 1998; Amzica and Steriade 1998). These patterns are associated with inability to form the spatially dispersed large synchronous networks (Massimini et al. 2005; Sakurai 2007) that are presumably the prerequisite of the wakeful state. At the scale of individual neurons, the hyperpolarized state causes sequential activation of a variety of slow intrinsic currents, which are primarily responsible for the various aforementioned EEG oscillations observed in NREM sleep (Crunelli and Hughes 2010). It is well established that GABAergic drugs act to decrease sleep latency, inhibit REM sleep, and increase stage 2 type NREM sleep (Lancel 1999). Figure 2.2 shows a summary diagram of the changes in activity amongst the various neuromodulators in the Awake, REM, and NREM states.

The reverse process is involved in waking up. The GABAergic neurons (principally in the VLPO, but also in the thalamus and elsewhere) are, for some reason,

Fig. 2.2 A diagram of changes in neuromodulators in different states of sleep and wakefulness. The *vertical axes* are arbitrary units (REM = rapid-eye-movement sleep, NREM = non-rapid-eye-movement sleep, ACh = acetylcholine, Hist = histamine, GABA = gamma-amino-butyric acid, NA = noradrenaline). The main Awake–Sleep differentiators are orexin and noradrenaline, whereas acetylcholine and histamine differentiate active (= REM and Awake) from inactive (NREM) states

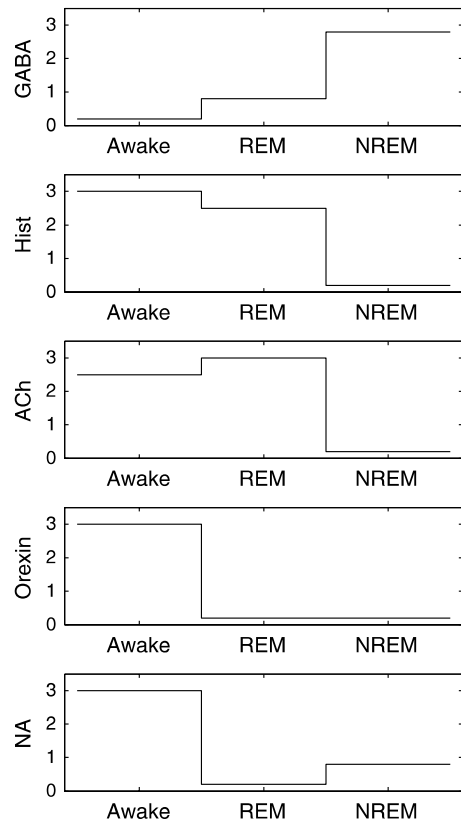

switched off. This removal of suppression of the brain-stem nuclei allows the activation of the, previously quiescent, excitatory aminergic, glutamatergic, cholinergic, and orexinergic systems. Acting via various receptors, these neuromodulators cause closure of potassium channels and neural depolarization. Thus this brain-stem reticular activation induces a depolarized active ‘UP’ state in the cortex; which in turn, allows the formation of spatially dispersed large synchronous networks, and hence the wakeful state (Massimini et al. 2009; Tononi and Sporns 2003). The obvious question is: ‘What could cause the VLPO to switch off?’ In the natural course of the day, this is primarily a question about the influences of the homeostatic and circadian processes. At the end of a good night’s sleep, the hyperpolarizing somnogen and circadian input has diminished to such an extent that the balance shifts in favor of the aminergic activating systems; which then inhibit the VLPO and initiate a positive feedback of arousal that is the inverse of that described above when the person falls asleep (Rempe et al. 2010; Riedner et al. 2007; Wilson et al. 2005). It is tempting to speculate that the increase in REM activity later in the night is acting as a ‘ping’ to test the progress of the sleep-induced synaptic remodelling. Unlike in the awake state, in REM sleep the brain aminergic and orexinergic systems are quiescent, and the cortex is partially activated with acetyl-

choline only. There is a good case to be made for the orexin system as performing the up-stream ‘executive function’ controlling wakefulness.

Perhaps the more intriguing question is: ‘What is happening when the person wakes in response to a strange noise in the house?’ This implies that the natural sub-conscious circadian and homeostatic rhythms have been overruled by a particular circumstance, which may be of specific importance to the person. The neurobiological details in this situation are not well understood at present, but there is clearly some degree of unconscious cognitive control of arousal during natural sleep in adults (Lovejoy and Krauzlis 2010). For example an unusual noise like a telephone ringing will be recognized and result in the adult waking (although anyone who has had children can tell you that a deeply asleep child is much more difficult to waken). It would seem that the arousal signal has originated from some sort of low-grade attention process that clearly functions quite well during natural sleep. This ‘top-down’ input—probably originating in the amygdala (Alkire et al. 2008)—is then able to switch off the GABAergic VLPO suppression of the aminergic and orexinergic arousal systems. At its heart, the final common pathway of natural waking is the activation of various arousal systems to alter intrinsic currents within the neurons to make them more depolarized and excitable. In contrast the defining feature of general anaesthesia is the complete inability to waken—even in response to the most severe painful stimulus imaginable. As is further elaborated below, general anaesthesia has at least two pharmacological effects to impair arousal:

1. The person is not able to turn the arousal-suppressing VLPO switch to the ‘off’ position; and thus set in train the downstream aminergic cortical activation processes (Plourde et al. 2006).
2. The anaesthesia also directly prevents the effector-organ of wakefulness (the neocortex) from responding to these aminergic depolarizing inputs with a suitable increase in spike-rate.

2.3 Mechanisms of General Anaesthesia

Surprisingly, general anaesthesia—like sleep—is also a phenomenon that is ubiquitous in the animal kingdom. Why this should be so is unknown, but it would seem likely that general anaesthesia is—in part—a chemical hijacking of natural sleep mechanisms (Franks 2008; Pang et al. 2009). At the molecular level this would involve interactions with evolutionarily conserved protein ion channels and pumps that are necessary for homeostatic control of nervous system activity. It is noteworthy that—while drugs which antagonize the excitatory neuromodulators, e.g. antihistamines, clonidine, antimuscarinics, will augment sleepiness—they are not, on their own, capable of inducing a state of proper anaesthesia. It seems that the ability to directly open the chloride channels is a prerequisite for a sedative drug to be an anaesthetic drug. There are clearly both similarities and differences between the two states:

- Similarities between sleep and general anaesthesia
 - Behavioral effects (unconsciousness/unawareness)

- EEG patterns (spindles, K-complexes, delta waves) (Ferenets et al. 2006; Koskinen et al. 2001)
- fMRI distribution metabolism (Peltier et al. 2005)
- Demonstration of general anaesthetic drug action on specific sleep nuclei (Kerssens et al. 2005; Nelson et al. 2002)
- some functional effect—restfulness/sleep rebound studies (Nelson et al. 2004).
- Differences between general anaesthesia and sleep
 - Unrousability
 - EEG burst suppression
 - Circadian rhythm disturbance
 - Side effects of general anaesthesia—nausea, etc.

As is described in the rest of this book, modelling of sleep and anaesthesia can be done at a variety of different levels. In the following sections we will explicitly concentrate on modelling the neocortical dynamics. We have used a mean-field method, but other neuron-by-neuron models have been published (Esser et al. 2009; Hill and Tononi 2005; Compte et al. 2003). The recently published paper by Esser and co-workers came to very similar conclusions about the neurophysiological mechanism of unconsciousness as those we have obtained from our model in this chapter. They compared various possible intrinsic neuronal current effects, with an increase in effective inhibitory post-synaptic potential (IPSP). They found that the increase in IPSP is the most likely mechanism to cause ‘gating’ of propagation of information flow between different neocortical regions in NREM. They suggested that this occurs during natural sleep as a result of the reduction in cholinergic tone. Acetylcholine acts via M1 and M2 receptors to inhibit GABA release in the supra-granular cortical layers (Salgado et al. 2007). As is described below, the critical point of difference between natural sleep and general anaesthesia is that activation of the cholinergic arousal systems on waking from natural sleep causes the IPSP to return to normal amplitude. In contrast, if the patient has an appreciable concentration of general anaesthetic drug present, the IPSP cannot be reduced in amplitude; because the drug is directly holding the chloride channels open—and hence the cortical ‘gating’ is held closed.

2.3.1 Mean-Field Modelling of General Anaesthesia and Sleep

In recent years variations of a mean-field model have been used with some success to model the cortical effects of both sleep and general anaesthesia (Steyn-Ross et al. 1999; Bojak and Liley 2005; Liley and Bojak 2005; Robinson et al. 2003; Sleight and Galletly 1997; Steyn-Ross et al. 2001; Steyn-Ross et al. 2004; Wilson et al. 2006; Wright and Liley 1995). The usual output from these models is the change in time of the mean soma potential—which can be related to the EEG signal. Since the EEG (or local field potential) is the most commonly observed experimental output, the output from the theoretical model can be directly compared to experimental results. In the following description, however, we will be using

the mean firing rate as the primary model output. The reason for choosing this is that the firing rate is clearly related to anaesthetic blockade of arousal (Antkowiak 1999). If the brain cannot achieve an active state, it does not have the information flux capacity to be complex enough to be conscious. The technical details of this model have been previously published (Sleigh et al. 2009; Wilson et al. 2006; Sleigh et al. 2010), but are described briefly below. The model has been parameterized using information about cortical anatomy, but the ideas could apply more generally to any suitably large interacting populations of inhibitory and excitatory neurons. We term the computer instantiation of this set of equations as the ‘pseudo-cortex’.

2.3.1.1 Mathematical Description of the Mean-Field Model

The model consists of a set of partial differential equations that describe the time evolution of the mean soma potential in a homogeneous, isotropic 2-dimensional sheet of macrocolumns. The macrocolumns contain a population of excitatory pyramidal neurons (denoted with subscript e), and a population inhibitory interneurons (subscript i). The two populations interact by means of ‘fast’ chemical synapses; that simulate AMPA and GABAA kinetics. We do not explicitly model the effects of gap junctions, glia, slow synaptic currents (NMDA or GABAB), or slower modulation of synaptic receptor trafficking. We have used the convention of $a \rightarrow b$ indicating that the direction of transmission in the synaptic connections is from the presynaptic nerve a , to post-synaptic nerve b . The model cortex is driven by a subcortical random white noise input (superscript sc), which is independent of the neocortical membrane potential. The time evolutions of the mean neuronal soma membrane potential (V_a) in each population of neurons, in response to synaptic input ($\rho_a \Psi_{ab} \Phi_{ab}$) are given by the following set of equations:

$$\tau_e \frac{\partial V_e}{\partial t} = V_e^{\text{rest}} - V_e + \delta V_e^{\text{rest}} + \rho_e \Psi_{ee} \Phi_{ee} + \rho_i \Psi_{ie} \Phi_{ie} \quad (2.1)$$

$$\tau_i \frac{\partial V_i}{\partial t} = V_i^{\text{rest}} - V_i + \rho_e \Psi_{ei} \Phi_{ei} + \rho_i \Psi_{ii} \Phi_{ii} \quad (2.2)$$

where τ_a are the neuron soma time constants, ρ_a are the strength of the post-synaptic potentials (they are multipliers of the total area under the post-synaptic potentials), Ψ_{ab} are the weighting functions that allow for the effects of reversal potentials and are described by the equation:

$$\Psi_{ab} = \frac{V_a^{\text{rev}} - V_b}{V_a^{\text{rev}} - V_a^{\text{rest}}}. \quad (2.3)$$

V^{rev} are the reversal potentials for chloride or sodium (as appropriate), and V^{rest} is the resting soma potential. (For clarity in later sections we have put the ‘rest’ as a subscript instead of a superscript). The Φ_{ab} are the synaptic input spike-rate densities which are described by the following equations (2.4) to (2.7). These are a set of second-order differential equations which describe the post-synaptic (dendritic) impact of a delta-function spike of activity at the synapse. The shape of the

post-synaptic potential is given by the solution (Green's function) to the differential equation, and is a so-called 'alpha-function'.

$$\left(\frac{\partial^2}{\partial t^2} + 2\gamma_{ee}\frac{\partial}{\partial t} + \gamma_{ee}^2\right)\Phi_{ee} = \gamma_{ee}^2(N_{ee}^\alpha\phi_{ee} + N_{ee}^\beta Q_e + \phi_{ee}^{sc}) \quad (2.4)$$

$$\left(\frac{\partial^2}{\partial t^2} + 2\gamma_{ei}\frac{\partial}{\partial t} + \gamma_{ei}^2\right)\Phi_{ei} = \gamma_{ei}^2(N_{ei}^\alpha\phi_{ei} + N_{ei}^\beta Q_e + \phi_{ei}^{sc}) \quad (2.5)$$

$$\left(\frac{\partial^2}{\partial t^2} + 2\gamma_{ie}\frac{\partial}{\partial t} + \gamma_{ie}^2\right)\Phi_{ie} = \gamma_{ie}^2(N_{ie}^\beta Q_i + \phi_{ie}^{sc}) \quad (2.6)$$

$$\left(\frac{\partial^2}{\partial t^2} + 2\gamma_{ii}\frac{\partial}{\partial t} + \gamma_{ii}^2\right)\Phi_{ii} = \gamma_{ii}^2(N_{ii}^\beta Q_i + \phi_{ii}^{sc}) \quad (2.7)$$

where γ_{ab} are the synaptic rate constants, N^α are the typical number of long-range connections between macrocolumns, and N^β the number of local intra-macrocolumn connections. It should be noted that these equations are describing the average impact of the excitatory and inhibitory dendritic input onto the soma of the neuron; and thus would include dendritic modulation and summation of pure synaptic input. The mean axonal velocity is given by v , and the characteristic length (the length at which the connectivity between neuronal populations decays to $1/e$) is $1/\Lambda_{ea}$. These spatial interactions amongst the macrocolumns are described by the two equations (2.8) and (2.9):

$$\left(\frac{\partial^2}{\partial t^2} + 2v\Lambda_{ee}\frac{\partial}{\partial t} + v^2\Lambda_{ee}^2 - v^2\nabla^2\right)\phi_{ee} = v^2\Lambda_{ee}^2 Q_e \quad (2.8)$$

$$\left(\frac{\partial^2}{\partial t^2} + 2v\Lambda_{ei}\frac{\partial}{\partial t} + v^2\Lambda_{ei}^2 - v^2\nabla^2\right)\phi_{ei} = v^2\Lambda_{ei}^2 Q_e. \quad (2.9)$$

The relationship between the mean neuronal population firing rate and the mean soma potential is given by sigmoidal functions (see (2.10) and (2.11)). An alternative interpretation is the probability of a neuron firing at a particular membrane potential.

$$Q_e(V_e) = \frac{Q_e^{\max}}{1 + \exp(-\pi(V_e - \theta_e)/\sqrt{3}\sigma_e)} \quad (2.10)$$

$$Q_i(V_i) = \frac{Q_i^{\max}}{1 + \exp(-\pi(V_i - \theta_i)/\sqrt{3}\sigma_i)} \quad (2.11)$$

where θ_a describes the inflection point membrane potential, and σ_a the standard deviation of the threshold potential. This parameter is a composite indicator of both: (i) the degree of homogeneity within the population of neurons, and (ii) whether the neurons show 'bursting' vs. 'regular-spiking' responses to injected current. The parameters and ranges used in our simulations are shown below in Table 2.1. The parameter values are a composite, derived from numerous different published papers in which the real neurophysiological values for individual neurons have been measured. The parameters are not freely adjusted post-hoc. Real nervous systems seem to tolerate quite a lot of variation in parameter values. A good argument could be made that the real nervous system will homeostatically adjust its connectivity

Table 2.1 Parameters for model cortex

Symbol	Description	Value
τ_e, τ_i	membrane time constant	15, 15 ms
$Q_{e,i}$	maximum firing rates	30, 60 Hz
$\Theta_{e,i}$	sigmoidal thresholds	-58, -58 mV
$\sigma_{e,i}$	standard deviation of thresholds	3, 5 mV
$\rho_{e,i}$	gain per synapse at resting voltage	0.001, -0.001 mV s
$V_{e,i}^{\text{rev}}$	cell reversal potential	0, -70 mV
$V_{e,i}^{\text{rest}}$	cell resting potential	-64, -64 mV
$N_{e,a}^{\alpha}$	long-range e to e or i connectivity	2500, 1000
N_{ea}^{β}	short-range e to e or i connectivity	1000
$N_{i,a}^{\beta}$	short-range i to e or i connectivity	500, 250
ϕ_{ea}^{sc}	mean e to e or i subcortical flux	80/s
γ_{ea}	baseline excitatory synaptic rate constant	100/s
γ_{ia}	baseline inhibitory synaptic rate constant	50/s
$L_{x,y}$	spatial length of cortex	25 cm
a_{mac}	area of macrocolumn	0.5 mm ²
Λ_{ea}	Inverse length connection scale	14/cm
v	mean axonal conduction speed	140 cm/s

(via synaptic up- and down-regulation) and excitability (via intrinsic ion channel expression) to maximize flexibility in its responses and activity regimes—and thus its ability to generate information.

2.3.2 Modelling Nociceptive Arousal

The neurobiological effects of a surgical stimulus are surprisingly poorly understood, but can be plausibly modeled as pain-induced activation of the various nuclei of the reticular activating system (as described above in Sect. 2.2). These ascending nuclei then act both:

1. indirectly to switch off the GABAergic neurons (in the VLPO, peri-aqueductal gray matter, and reticular thalamus) that are dominant in the state of slow-wave sleep; and also,
2. directly to depolarize the thalamo-cortical structures.

The increase in excitatory neuromodulatory substances (amines, orexin, acetylcholine) closes various potassium channels (Arrigoni et al. 2006; Espinosa et al. 2008; Leonard and Llinas 1994; McCormick 1989; McCormick et al. 1991; Rowell et al. 2003; Saint-Mleux et al. 2004; Wu et al. 2004), and thus causes the resting membrane potential to become more depolarized. This is easily incorporated in the

model as a depolarization of the resting soma potential V^{rest} (by setting the δV_{rest} offset to a positive value). We examined the effects of altering the resting membrane potential values over quite a large range, from -68 mV to -56 mV. Alternatively the arousal effect could also be included in the model as increased excitatory sub-cortical input flux (ϕ^{sc}). This approach has mathematically equivalent effects on the dynamics of the pseudo-cortex.

2.3.2.1 Modelling Anaesthetic-Induced Suppression of Arousal

There is ongoing debate about the exact molecular mechanisms of action of general anaesthetics, but it is widely acknowledged that—for intravenous drugs like propofol and etomidate—they have fairly specific actions to increase the area under the inhibitory post-synaptic potential (IPSP), and thus increase inhibition within the brain (Campagna et al. 2003; Grasshoff et al. 2006; Rudolph and Antkowiak 2004; Antkowiak 1999). This effect is mainly the result of prolongation of the IPSP, rather than an increase in the peak amplitude of the IPSP. In higher concentrations this action is independent of the presence of endogenous GABA. At the dose required to suppress awakening to a surgical incision, propofol increases the area of the IPSP between 1.5-fold and 3-fold. The opening of the chloride channels in the post-synaptic membrane also increases the effective membrane conductance. This has the effect of decreasing the degree of depolarization induced by excitatory post-synaptic currents—which magnifies the inhibition effects. We have not included this in our modelling; and thus have tended to underestimate the inhibitory effects of propofol. We have also not included the hyperpolarizing effects in tonic non-synaptic GABA receptors. While we have concentrated on the GABAergic synaptic effects of general anaesthetic drugs, we acknowledge other possible effects on intrinsic neuronal channels; especially by volatile anaesthetic agents. This group of drugs is well known to have a multitude of actions, including opening various 2-pore-domain potassium channels, and NMDA receptor antagonism (Franks 2008). The effects on the model are more fully explored later in this chapter.

The most obvious and important question is whether the simple IPSP augmentation by propofol, is sufficient to explain the extraordinary ability of general anaesthetic drugs to block extreme nociceptive arousal of the cerebral cortex. Assuming that the model has at least some fidelity in representing the dynamics of the cerebral cortex, we may then use this model to explore possible answers to this question. Accordingly, the natural space to envisage the competing effects of the general anaesthetic drug and those of painful arousal has three axes:

- IPSP magnitude, which is an indicator of the general anaesthetic effect.
- Change in resting membrane potential (via δV_{rest}) which reflects the input of brain-stem neuromodulator activation. This $\hat{I} V_{\text{rest}}$ parameter will be a composite indicator of the balance between activation of the sleep systems (to decrease δV_{rest}) and their opposition by nociceptive input (to increase δV_{rest}).
- The mean neuronal firing rate is the output variable on the vertical axis.

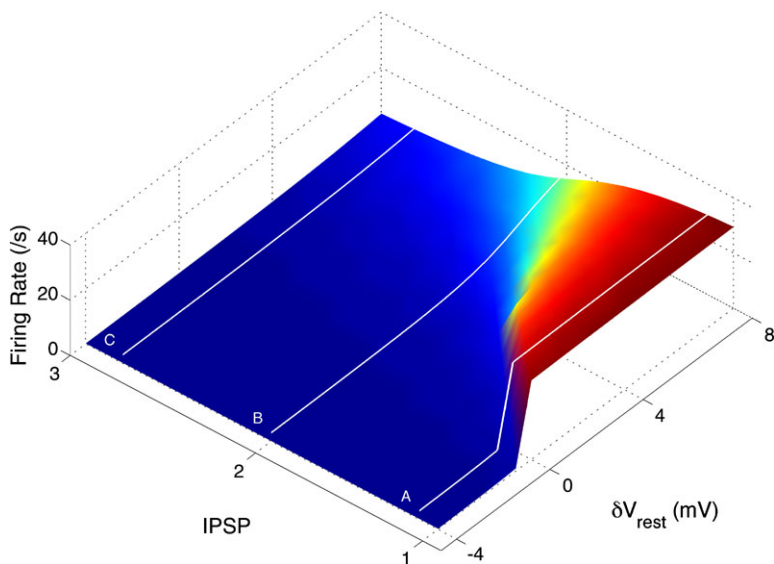

Fig. 2.3 Diagram of model steady-state solutions in neuronal firing rate (*vertical axis*) versus changes in inhibitory post-synaptic potential (IPSP) and resting membrane potential (δV_{rest}), on the *horizontal axes*. The trajectories of steady states followed by increasing δV_{rest} at three fixed magnitudes of IPSP are shown by the *white lines*, ‘A’ (Sleep-wake), ‘B’ (Sedation), and ‘C’ (Anaesthesia). These correspond to the diagrams ‘A’, ‘B’, and ‘C’ in Fig. 2.4

We obtained the steady-state solutions to the set of equations that comprise the model at various input parameter values (IPSP and δV_{rest}). We assume that a high-firing state is a necessary (but not sufficient) condition for wakefulness to occur in a real animal. Conversely a low-firing state is thought to be consonant with unconscious states—and precludes wakefulness. Using parameters as shown in Table 2.1, the resultant output from the model is shown in Figs. 2.3 and 2.4. The subplots (Figs. 2.4A to 2.4C) show trajectories indicated by the white lines on the manifold in Fig. 2.3. These are the response of the model cortex to a progressive increase in δV_{rest} such as might occur with painful stimulation.

- Figure 2.4A: If there is no increase in IPSP magnitude (i.e. in a state of natural sleep—in the absence of general anaesthesia), it can be seen that a small neuromodulator-induced depolarization of the resting membrane potential ($\delta V_{rest} \approx 2\text{--}3$ mV) results in an abrupt jump from a low-firing state to an active state (firing rate 25/s). This would correspond to the cortex moving from NREM to the wakeful state in response to activation of the aforementioned brain-stem neuromodulator systems. It is interesting to note that this abrupt change is a property that is intrinsic to the cortical population behavior, and does not require a separate mutually inhibitory brain-stem flip-flop system.
- Figures 2.4B, and 2.4C show the effects if propofol is included in the model and the magnitude (and duration) of the IPSP is increased. The region of interest shifts to the left of the manifold in Fig. 2.3. We see that there has to be a much

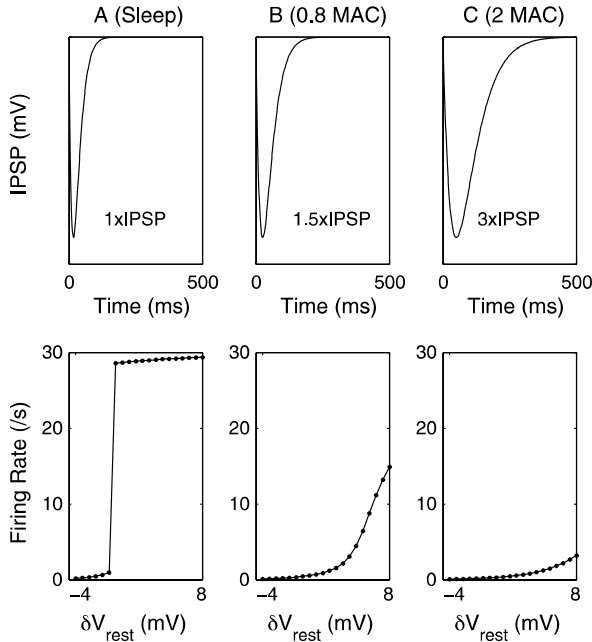

Fig. 2.4 Changes in firing rate with changes in resting membrane potential (*lower graphs*) for three different values of IPSP magnitude (shown in *upper graphs*). MAC = minimal alveolar concentration of anaesthetic vapor that prevents movement in response to a surgical incision in 50% patients. This concept has been loosely applied to the effects of the intravenous drug propofol. There are data to support the assertion that the concentration of propofol (2 μM) that is required to increase the IPSP area to 150% of the starting values is associated with sedation/light anaesthesia, and that required (8 μM) to increase the IPSP area to 300% of the starting value is associated with deep burst-suppression pattern anaesthesia

greater arousal-induced activation of neuromodulators ($\delta V_{\text{rest}} \approx 10$ mV) to allow the cortex to achieve some sort of active state, and once the IPSP magnitude is greater than about twice normal, the firing rate of the active state is much diminished (≈ 5 /s)—no matter how much the soma potential is depolarized. The synaptic effects of the general anaesthesia always ‘trump’ the intrinsic effects of the nociceptive activation of the neuromodulators. This makes intuitive sense. The effect of the increased IPSP area is to amplify negative feedback on excitatory neurons. Thus any increased activity in the excitatory/pyramidal cells quickly translates into increased activity in their ‘downstream’ inhibitory interneurons which then ‘chokes’ the possible ceiling of activity in the model cortex. More excitatory activity simply results in more inhibitory activity. To the extent that the model reflects reality, we may conclude that; if the IPSP is increased by general anaesthetic drugs, the cortex become increasingly difficult to activate by the usual arousal mechanisms of potassium channel closure and neuronal depolarization. Once the IPSP is greater than double the baseline amplitude, it becomes almost impossible to activate the cortex by increasing intrinsic neuronal excitability. The low-firing

coma state can only be reversed by blockade of chloride conductance, or possibly be an increased EPSP.

It is also of interest that the bistability of the pseudo-cortex is reduced as the IPSP increases—and the transition between silent and firing modes becomes continuous rather than discontinuous.

2.3.3 Robustness of Parameters and Drug Interactions

The conclusions are largely independent of parameter values. The important point of all this is the fact that the high-firing state exists as a sort of ‘hilltop’ in the back right-hand side of the manifold. Changes in various parameters alter the size of the ‘hilltop’ in a predictable fashion. Increase in excitability (increases in N_{ee} , N_{ii} , sub-cortical input (ϕ_{ea}^{sc}), EPSP magnitude (ρ_e), and decreases in N_{ei} , and N_{ie}) will increase the area of the ‘hilltop’ and shift it forward and to the left—thus increasing the propensity for activity and wakefulness. Parameter changes in the opposite direction will decrease the size of the ‘hilltop’ and shift it backwards and to the right—thus increasing the propensity for coma. However, the basic shape of the ‘hilltop’ is unchanged; with increasing IPSP always reducing the peak firing rate.

The known anaesthetic drug interactions are consonant with this model. Drugs that open potassium channels and hence hyperpolarize V_{rest} (opioids), and drugs that reduce ρ_e (ketamine) will potentiate the GABAergic anaesthesia of propofol. Indeed volatile anaesthetic agents are known to have a significant potassium channel opening activity themselves (Franks 2008). Drugs that inhibit the aminergic arousal systems (such as dexmedetomidine) also potentiate general anaesthesia. Drugs that close potassium channels (such a physostigmine (Meuret et al. 2000; Plourde et al. 2003)), and enhance ρ_e (pentylenetetrazole, or direct glutamate application) will tend to antagonize GABAergic general anaesthesia. However, the ability of these antagonists to recover the conscious state is limited to sedative doses of propofol. Alkire and co-workers have done some seminal work on the behavioral reversal of anaesthesia (Alkire et al. 2007, 2009). They injected the cholinergic drug nicotine into the central medial thalamus, and found that rats, which had received about 0.5MAC sevoflurane (i.e. just enough to eliminate their loss-of-righting reflex) woke-up. That is they regained normal behavior patterns, even in the ongoing presence of sevoflurane. There are various interpretations of these results, but we would suggest that the sevoflurane had impaired the rats’ cortical activity so as to move off the active state ‘hilltop’ (i.e. back along the Fig. 2.4A–B trajectory). The injection of nicotine in a crucial area of the thalamus with widely diverging cortical projection, was enough to depolarize the cortex back up the ‘hilltop’, and thus the rat regained wakefulness. Although it is not explicitly described in the paper, it appears that the nicotine-induced awakening is not successful if a full one-MAC dose of sevoflurane was used, i.e. trajectory 2.4C in Figs. 2.3 and 2.4. We can conclude that at higher doses of propofol, the IPSP-induced suppression of firing rate is not able to be effectively opposed by potassium channel closure by boosting (δV_{rest}).

The model thus explains the experimental observation that deep anaesthesia could only be reversed chemically by direct chloride channel blockade.

This exposes one problem with our model. As mentioned previously, an active cortex is necessary but not sufficient for wakefulness. We do not distinguish between the state of REM sleep and wakefulness. On both states the cortex is in an active state—however, in REM sleep the ‘consciousness’ is entirely internally directed; whereas in the wakeful state input from the external world is included in the consciousness. Analogous states are often seen during recovery from general anaesthesia. The patient commonly has an active cortex—as measured by an EEG monitor—but has no interaction with the external world, and is unresponsive to verbal command. The reasons for this lack of perception are unknown at present; but presumably are related in some way to aminergic and orexinergic functions. For anyone who wants to develop a monitor of anaesthesia, this question is clearly of utmost relevance.

2.4 Conclusions

If this model has some correspondence with reality, we may summarize the relationship between natural sleep and GABAergic anaesthesia as follows.

- In natural sleep there is activation of specific GABAergic pathways involving hypothalamic and brain-stem systems that cause hyperpolarization of the thalamo-cortical systems, which in turn, precipitates the state of slow-wave sleep. This state is characterized primarily by increased firing rates in GABAergic neurons, and an increase in effective IPSP that is contingent on low levels of acetylcholine. In this state the GABAergic systems are under normal homeostatic control, and even mild stimuli are able to switch them off and allow normal neuromodulator-induced cortical depolarization, and the transition to wakefulness (or REM sleep); see Figs. 2.3 and 2.4A.
- At low (sedative) doses of propofol, the IPSPs are moderately increased by the drug; which allows the GABAergic brain systems to become dominant and the subject has an increased tendency to enter the sleep state. However, an increased intensity of nociceptive stimuli may still induce sufficient depolarization to achieve the awake state; see Figs. 2.3 and 2.4B.
- At a higher (anaesthetic) dose of propofol, the large-scale global increase in inhibitory gain within the brain is of such a magnitude that no amount of nociceptive-induced closure of potassium channels is able to counteract the IPSP effects and the cortex is denied the possibility of reaching a high-firing state that is necessary for the state of wakefulness. This absolute resistance to nociceptive arousal is the sine qua non of the state of general anaesthesia: see Figs. 2.3 and 2.4C.

Acknowledgements The authors’ research was supported by the Marsden Fund of New Zealand and the Neurological Foundation of New Zealand.

References

- Alkire M, McReynolds J, Hahn E, Trivedi A (2007) Thalamic microinjection of nicotine reverses sevoflurane-induced loss of righting reflex in the rat. *Anesthesiology* 107(2):264–272
- Alkire MT, Gruver R, Miller J, McReynolds J, Hahn E, Cahill L (2008) Neuroimaging analysis of an anesthetic gas that blocks human emotional memory. *Proc Natl Acad Sci USA* 105(5):1722–1727
- Alkire MT, Asher CD, Franciscus AM, Hahn EL (2009) Thalamic microinfusion of antibody to a voltage-gated potassium channel restores consciousness during anesthesia. *Anesthesiology* 110(4):766–773
- Amzica F, Steriade M (1998) Electrophysiological correlates of sleep delta waves. *Electroencephalogr Clin Neurophysiol* 107(2):69–83
- Antkowiak B (1999) Different actions of general anesthetics on the firing patterns of neocortical neurons mediated by the GABA(a) receptor. *Anesthesiology* 91(2):500–511
- Arrigoni E, Chamberlin N, Saper CB, McCarley RW (2006) Adenosine inhibits basal forebrain cholinergic and noncholinergic neurons in vitro. *Neuroscience* 140(2):403–413
- Basheer R, Bauer A, Elmenhorst D, Ramesh V, McCarley RW (2007) Sleep deprivation upregulates $\alpha 1$ adenosine receptors in the rat basal forebrain. *Neuroreport* 18(18):1895–1899
- Behn C, Brown EN, Scammell T, Kopell N (2007) Mathematical model of network dynamics governing mouse sleep-wake behavior. *J Neurophysiol* 97(6):3828–3840
- Bojak I, Liley DT (2005) Modeling the effects of anesthesia on the electroencephalogram. *Phys Rev E* 71:041902
- Campagna JA, Miller K, Forman SA (2003) Mechanisms of actions of inhaled anesthetics. *N Engl J Med* 348(21):2110–2124
- Clearwater JM, Rennie CJ, Robinson PA (2008) Mean field model of acetylcholine mediated dynamics in the thalamocortical system. *J Theor Biol* 255(3):287–298
- Compte A, Sanchez-Vives MV, McCormick DA, Wang X (2003) Cellular and network mechanisms of slow oscillatory activity (<1 Hz) and wave propagations in a cortical network model. *J Neurophysiol* 89(5):2707–2725
- Contreras D, Destexhe A, Sejnowski TJ, Steriade M (1996) Control of spatiotemporal coherence of a thalamic oscillation by corticothalamic feedback. *Science* 274(5288):771–774
- Crunelli V, Hughes S (2010) The slow (<1 Hz) rhythm of non-rem sleep: a dialogue between three cardinal oscillators. *Nat Neurosci* 13(1):9–17
- Destexhe A, Contreras D, Steriade M (1999) Cortically-induced coherence of a thalamic-generated oscillation. *Neuroscience* 92(2):427–443
- Espinosa F, Torres-Vega MA, Marks GA, Joho RH (2008) Ablation of kv3.1 and kv3.3 potassium channels disrupts thalamocortical oscillations in vitro and in vivo. *J Neurosci* 28(21):5570–5581
- Esser SK, Hill S, Tononi G (2009) Breakdown of effective connectivity during slow wave sleep: investigating the mechanism underlying a cortical gate using large-scale modeling. *J Neurophysiol* 102(4):2096–2111
- Ferenets R, Lipping T, Suominen P, Turunen J, Puumala P, Jantti V, Himanen SL, Huotari AM (2006) Comparison of the properties of EEG spindles in sleep and propofol anesthesia. *Conf Proc IEEE Eng Med Biol Soc* 1:6356–6359
- Franks NP (2008) General anaesthesia: from molecular targets to neuronal pathways of sleep and arousal. *Nat Rev Neurosci* 9(5):370–386
- Fuentealba P, Timofeev I, Bazhenov M, Sejnowski TJ, Steriade M (2005) Membrane bistability in thalamic reticular neurons during spindle oscillations. *J Neurophysiol* 93(1):294–304
- Fulcher BD, Phillips AJ, Robinson PA (2008) Modeling the impact of impulsive stimuli on sleep-wake dynamics. *Phys Rev E* 78(5):051920
- Fuller PM, Gooley JJ, Saper CB (2006) Neurobiology of the sleep-wake cycle: sleep architecture, circadian regulation, and regulatory feedback. *J Biol Rhythms* 21(6):482–493
- Fuller PM, Saper CB, Lu J (2007) The pontine rem switch: past and present. *J Physiol* 584(3):735–741

- Goutagny R, Luppi PH, Salvert D, Lapray D, Gervasoni D, Fort P (2008) Role of the dorsal paraventricular nucleus in paradoxical (rapid eye movement) sleep generation: a combined electrophysiological and anatomical study in the rat. *Neuroscience* 152(3):849–857
- Grasshoff C, Drexler B, Rudolph U, Antkowiak B (2006) Anaesthetic drugs: linking molecular actions to clinical effects. *Curr Pharm Des* 12(28):3665–3679
- Harris KD (2005) Neural signatures of cell assembly organization. *Nat Rev Neurosci* 6(5):399–407
- Hill S, Tononi G (2005) Modeling sleep and wakefulness in the thalamocortical system. *J Neurophysiol* 93(3):1671–1698
- Hudetz AG (2008) Are we unconscious during general anesthesia? *Int Anesthesiol Clin* 46(3):25–41
- Hudetz AG, Wood JD, Kampine JP (2003) Cholinergic reversal of isoflurane anesthesia in rats as measured by cross-approximate entropy of the electroencephalogram. *Anesthesiology* 99(5):1125–1131
- Kerssens C, Hamann S, Peltier S, Hu XP, Byas-Smith MG, Sebel PS (2005) Attenuated brain response to auditory word stimulation with sevoflurane: a functional magnetic resonance imaging study in humans. *Anesthesiology* 103(1):11–19
- Koskinen M, Seppanen T, Tuukkanen J, Yli-Hankala A, Jantti V (2001) Propofol anesthesia induces phase synchronization changes in EEG. *Clin Neurophysiol* 112(2):386–392
- Krueger JM (2008) The role of cytokines in sleep regulation. *Curr Pharm Des* 14(32):3408–3416
- Krueger JM, Rector DM, Roy S, Van Dongen HP, Belenky G, Panksepp J (2008) Sleep as a fundamental property of neuronal assemblies. *Nat Rev Neurosci* 9(12):910–919
- Lancel M (1999) Role of GABAA receptors in the regulation of sleep: initial sleep responses to peripherally administered modulators and agonists. *Sleep* 22(1):33–42
- Leonard CS, Llinas R (1994) Serotonergic and cholinergic inhibition of mesopontine cholinergic neurons controlling REM sleep: an in vitro electrophysiological study. *Neuroscience* 59(2):309–330
- Leung CG, Mason P (1999) Physiological properties of raphe magnus neurons during sleep and waking. *J Neurophysiol* 81(2):584–595
- Liley DT, Bojak I (2005) Understanding the transition to seizure by modeling the epileptiform activity of general anesthetic agents. *J Clin Neurophysiol* 22(5):300–313
- Lin JS, Sakai K, Jouvet M (1988) Evidence for histaminergic arousal mechanisms in the hypothalamus of cat. *Neuropharmacology* 27(2):111–122
- Lin JS, Sakai K, Vanni-Mercier G, Jouvet M (1989) A critical role of the posterior hypothalamus in the mechanisms of wakefulness determined by microinjection of muscimol in freely moving cats. *Brain Res* 479(2):225–240
- Lovejoy LP, Krauzlis RJ (2010) Inactivation of primate superior colliculus impairs covert selection of signals for perceptual judgments. *Nat Neurosci* 13:261–266
- Lu J, Nelson LE, Franks NP, Maze M, Chamberlin NL, Saper CB (2008) Role of endogenous sleep-wake and analgesic systems in anesthesia. *J Comp Neurol* 508(4):648–662
- Luppi PH, Gervasoni D, Boissard R, Verret L, Goutagny R, Peyron C, Salvert D, Leger L, Barbagli B, Fort P (2004) Brainstem structures responsible for paradoxical sleep onset and maintenance. *Arch Ital Biol* 142(4):397–411
- Luppi PH, Gervasoni D, Verret L, Goutagny R, Peyron C, Salvert D, Leger L, Fort P (2006) Paradoxical (REM) sleep genesis: the switch from an aminergic-cholinergic to a GABAergic-glutamatergic hypothesis. *J Physiol (Paris)* 100(5–6):271–283
- Massimini M, Ferrarelli F, Huber R, Esser SK, Singh H, Tononi G (2005) Breakdown of cortical effective connectivity during sleep. *Science* 309(5744):2228–2232
- Massimini M, Tononi G, Huber R (2009) Slow waves, synaptic plasticity and information processing: insights from transcranial magnetic stimulation and high-density EEG experiments. *Eur J Neurosci* 29(9):1761–1770
- McCarley R (2007) Neurobiology of REM and NREM sleep. *Sleep Medicine* 8(4):302–330

- McCarley RW, Chokroverty S (2007) Introduction to special issue of sleep medicine. *Sleep Medicine* 8(4):289–290
- McCormick DA (1989) Cholinergic and noradrenergic modulation of thalamocortical processing. *Trends Neurosci* 12(6):215–221
- McCormick DA, Pape HC, Williamson A (1991) Actions of norepinephrine in the cerebral cortex and thalamus: implications for function of the central noradrenergic system. *Prog Brain Res* 88:293–405
- Meuret P, Backman SB, Bonhomme V, Plourde G, Fiset P (2000) Physostigmine reverses propofol-induced unconsciousness and attenuation of the auditory steady state response and bispectral index in human volunteers. *Anesthesiology* 93(3):708–717
- Moreno-Balandran E, Garzon M, Bodalo C, Reinoso-Suarez F, de Andres I (2008) Sleep-wakefulness effects after microinjections of hypocretin 1 (orexin a) in cholinceptive areas of the cat oral pontine tegmentum. *Eur J Neurosci* 28(2):331–341
- Nelson LE, Guo TZ, Lu J, Saper CB, Franks NP, Maze M (2002) The sedative component of anesthesia is mediated by GABA(A) receptors in an endogenous sleep pathway. *Nat Neurosci* 5(10):979–984
- Nelson LE, Franks NP, Maze M (2004) Rested and refreshed after anesthesia? Overlapping neurobiologic mechanisms of sleep and anesthesia. *Anesthesiology* 100(6):1341–1342
- Ohno K, Sakurai T (2008) Orexin neuronal circuitry: role in the regulation of sleep and wakefulness. *Front Neuroendocrinol* 29(1):70–87
- Pang DS, Robledo CJ, Carr DR, Gent TC, Vyssotski AL, Caley A, Zecharia AY, Wisden W, Brickley SG, Franks NP (2009) An unexpected role for task-3 potassium channels in network oscillations with implications for sleep mechanisms and anesthetic action. *Proc Natl Acad Sci USA* 106(41):17,546–17,551
- Peltier SJ, Kerssens C, Hamann SB, Sebel PS, Byas-Smith M, Hu X (2005) Functional connectivity changes with concentration of sevoflurane anesthesia. *Neuroreport* 16(3):285–288
- Phillips AJ, Robinson PA (2008) Sleep deprivation in a quantitative physiologically based model of the ascending arousal system. *J Theor Biol* 255(4):413–423
- Plourde G, Chartrand D, Fiset P, Font S, Backman SB (2003) Antagonism of sevoflurane anaesthesia by physostigmine: effects on the auditory steady-state response and bispectral index. *Br J Anaesth* 91(4):583–586
- Plourde G, Belin P, Chartrand D, Fiset P, Backman SB, Xie G, Zatorre RJ (2006) Cortical processing of complex auditory stimuli during alterations of consciousness with the general anesthetic propofol. *Anesthesiology* 104(3):448–457
- Rempe MJ, Best J, Terman D (2010) A mathematical model of the sleep/wake cycle. *J Math Biol* 60(5):615–644
- Riedner BA, Vyazovskiy VV, Huber R, Massimini M, Esser S, Murphy M, Tononi G (2007) Sleep homeostasis and cortical synchronization: Iii a high-density EEG study of sleep slow waves in humans. *Sleep* 30(12):1643–1657
- Robinson PA, Rennie CJ, Rowe DL, O'Connor SC, Wright JJ, Gordon E, Whitehouse RW (2003) Neurophysical modeling of brain dynamics. *Neuropsychopharmacology* 28(Suppl 1):S74–S79
- Rosenwasser AM (2009) Functional neuroanatomy of sleep and circadian rhythms. *Brain Res Rev* 61(2):281–306
- Rowell PP, Volk KA, Li J, Bickford ME (2003) Investigations of the cholinergic modulation of GABA release in rat thalamus slices. *Neuroscience* 116(2):447–453
- Roy S, Krueger JM, Rector DM, Wan Y (2008) A network model for activity-dependent sleep regulation. *J Theor Biol* 253(3):462–468
- Rudolph U, Antkowiak B (2004) Molecular and neuronal substrates for general anaesthetics. *Nat Rev Neurosci* 5(9):709–720
- Saint-Mieux B, Eggermann E, Bisetti A, Bayer L, Machard D, Jones BE, Muhlethaler M, Serafin M (2004) Nicotinic enhancement of the noradrenergic inhibition of sleep-promoting neurons in the ventrolateral preoptic area. *J Neurosci* 24(1):63–67
- Saito H, Sakai K, Jouvet M (1977) Discharge patterns of the nucleus parabrachialis lateralis neurons of the cat during sleep and waking. *Brain Res* 134(1):59–72

- Sakurai T (2007) The neural circuit of orexin (hypocretin): maintaining sleep and wakefulness. *Nat Rev Neurosci* 8(3):171–181
- Salgado H, Bellay T, Nichols JA, Bose M, Martinolich L, Perrotti L, Atzori M (2007) Muscarinic m2 and m1 receptors reduce GABA release by Ca^{2+} channel modulation through activation of $\text{PI}_3\text{K}/\text{Ca}^{2+}$ -independent and $\text{PLC}/\text{Ca}^{2+}$ -dependent PKC. *J Neurophysiol* 98(2):952–965
- Saper CB, Cano G, Scammell TE (2005) Homeostatic, circadian, and emotional regulation of sleep. *J Comp Neurol* 493(1):92–98
- Siegel JM (2009) Sleep viewed as a state of adaptive inactivity. *Nat Rev Neurosci* 10(10):747–753
- Sleight JW, Galletly DC (1997) A model of the electrocortical effects of general anaesthesia. *Br J Anaesth* 78(3):260–263
- Sleight JW, Vizuete JA, Voss L, Steyn-Ross A, Steyn-Ross M, Marcuccilli CJ, Hudetz AG (2009) The electrocortical effects of enflurane: experiment and theory. *Anesth Analg* 109(4):1253–1262
- Sleight JW, Wilson MT, Voss LJ, Steyn-Ross DA, Steyn-Ross ML, Li X (2010) A continuum model for the dynamics of the phase transition from slow-wave sleep to rem sleep. In: A SRD, L SRM (eds) *Modeling phase transitions in the brain*. Springer, New York, pp 203–221
- Steriade M, Amzica F (1998) Coalescence of sleep rhythms and their chronology in corticothalamic networks. *Sleep Res Online* 1(1):1–10
- Steriade M, Timofeev I, Grenier F (2001) Natural waking and sleep states: a view from inside neocortical neurons. *J Neurophysiol* 85(5):1969–1985
- Steyn-Ross DA, Steyn-Ross ML, Wilcocks LC, Sleight JW (2001) Toward a theory of the general-anesthetic-induced phase transition of the cerebral cortex. ii. numerical simulations, spectral entropy, and correlation times. *Phys Rev E* 64(1):011918
- Steyn-Ross ML, Steyn-Ross DA, Sleight JW, Liley DT (1999) Theoretical electroencephalogram stationary spectrum for a white-noise-driven cortex: evidence for a general anesthetic-induced phase transition. *Phys Rev E* 60(6):7299–7311
- Steyn-Ross ML, Steyn-Ross DA, Sleight JW (2004) Modelling general anaesthesia as a first-order phase transition in the cortex. *Prog Biophys Mol Biol* 85(2–3):369–385
- Sukhotinsky I, Zalkind V, Lu J, Hopkins DA, Devor MCBS (2007) Neural pathways associated with loss of consciousness caused by intracerebral microinjection of GABAA-active anesthetics. *Eur J Neurosci* 25(5):1417–1436
- Tononi G (2009) Slow wave homeostasis and synaptic plasticity. *J Clin Sleep Medicine* 5(2):S16–S19
- Tononi G, Cirelli C (2006) Sleep function and synaptic homeostasis. *Sleep Med Rev* 10(1):49–62
- Tononi G, Sporns O (2003) Measuring information integration. *BMC Neurosci* 4:31
- Verret L, Fort P, Gervasoni D, Leger L, Luppi PH (2006) Localization of the neurons active during paradoxical (rem) sleep and projecting to the locus coeruleus noradrenergic neurons in the rat. *J Comp Neurol* 495(5):573–86
- Villablanca JR (2004) Counterpointing the functional role of the forebrain and of the brainstem in the control of the sleep-waking system. *J Sleep Res* 13(3):179–208
- Vyazovskiy VV, Cirelli C, Pfister-Genskow M, Faraguna U, Tononi G (2008) Molecular and electrophysiological evidence for net synaptic potentiation in wake and depression in sleep. *Nat Neurosci* 11(2):200–208
- Wilson MT, Steyn-Ross ML, Steyn-Ross DA, Sleight JW (2005) Predictions and simulations of cortical dynamics during natural sleep using a continuum approach. *Phys Rev E* 72(5):051910
- Wilson MT, Steyn-Ross DA, Sleight JW, Steyn-Ross ML, Wilcocks LC, Gillies IP (2006) The k-complex and slow oscillation in terms of a mean-field cortical model. *J Comput Neurosci* 21(3):243–257
- Winsky-Sommerer R (2009) Role of GABAA receptors in the physiology and pharmacology of sleep. *Eur J Neurosci* 29(9):1779–1794
- Wright JJ, Liley DT (1995) Simulation of electrocortical waves. *Biol Cybern* 72(4):347–356

- Wu M, Zaborszky L, Hajszan T, van den Pol AN, Alreja M (2004) Hypocretin/orexin innervation and excitation of identified septohippocampal cholinergic neurons. *J Neurosci* 24(14):3527–3536
- Zecharia AY, Nelson LE, Gent TC, Schumacher M, Jurd R, Rudolph U, Brickley SG, Maze M, Franks NP (2009) The involvement of hypothalamic sleep pathways in general anesthesia: testing the hypothesis using the GABAA receptor beta3n265m knock-in mouse. *J Neurosci* 7(7):2177–2187

Part I

Sleep

Chapter 3

Quantitative Modeling of Sleep Dynamics

P.A. Robinson, A.J.K. Phillips, B.D. Fulcher, M. Puckeridge, J.A. Roberts,
and C.J. Rennie

3.1 Introduction

Brain dynamics involves interactions across many scales—spatially from microscopic (synapses, neurons) to the whole brain, and temporally from the sub-millisecond range (ion channel dynamics) to seconds [electroencephalographic (EEG) and functional MRI phenomena] or even years (learning, memory, development). Except under artificial conditions that isolate a single scale, these multiscale aspects of the underlying physiology and anatomy must be included to model the behavior adequately at any scale. In particular, bottom-up influences of microscale behavior must be included to understand large-scale dynamics, which in turn has top-down influences at the microscale (Binney et al. 1992).

Sleep–wake (or arousal) dynamics involves not just changes in the cortex, as is sometimes assumed, but require the dynamics of the whole corticothalamic system to be considered, since it is this composite system that generates the dominant EEG rhythms that are widely used in characterizing arousal states (Nunez 1995; Nunez and Srinivasan 2006; Robinson et al. 2002; Deco et al. 2008; Steriade et al. 1990, 1997). Moreover, the transitions between wake and sleep states of the brain are primarily generated by the ascending arousal system of the dorsal hypothalamus and brainstem, driven by homeostatic influences, light inputs via the suprachiasmatic nucleus, and cortical feedbacks (Kandel et al. 2000; Saper et al. 2001). Hence, it is necessary to include network aspects that connect the nuclei of these various systems, ultimately combining them into a dynamical whole. Figure 3.1 shows some of the key brain structures, connections, and feedbacks involved in arousal dynamics.

P.A. Robinson (✉)
School of Physics, The University of Sydney, Sydney, NSW 2006, Australia
e-mail: robinson@physics.usyd.edu.au

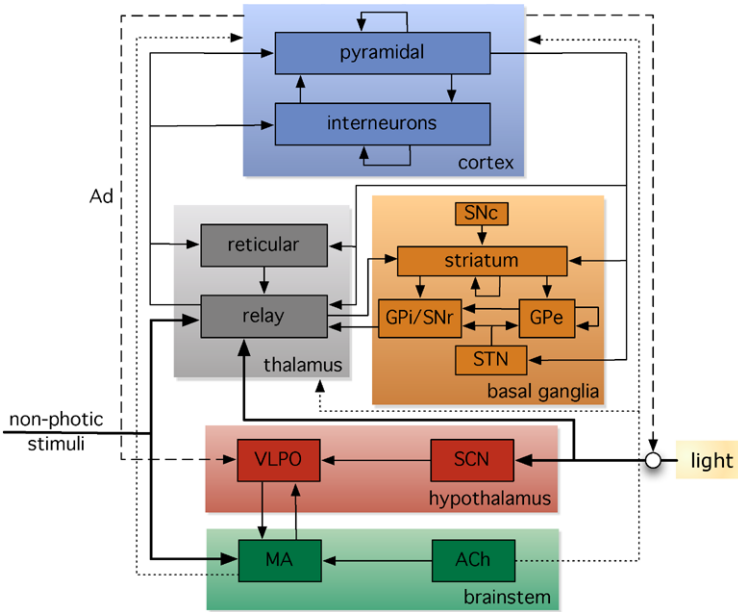

Fig. 3.1 Schematic of structures involved in corticothalamic generation of EEGs and the brain-stem-hypothalamus ascending arousal system, with some of their main inputs, connections, and feedbacks shown by arrows. The basal ganglia are also shown

Neural-field theories (often termed mean-field theories) provide a natural basis for modeling and analyzing multiscale neural systems. Moreover, links to typical measurements can be directly included—an essential point because most measurement processes aggregate over many neurons and all modify signals in some way. Mean-field theories that incorporate measurement effects thus provide natural links between theoretical and experimental results. In the neural-field models described here, averages are taken over microscopic neural structure to obtain mean-field descriptions on scales from tenths of a millimeter up to the whole brain, incorporating representations of the anatomy and physiology of separate excitatory and inhibitory neural populations, nonlinear neural responses, multiscale interconnections, synaptic, dendritic, cell-body, and axonal dynamics, and feedbacks between structures (Breakspear et al. 2006; Freeman 1975; Jirsa and Haken 1996; Lopes da Silva et al. 1974; Nunez 1974, 1995; Rennie et al. 1999, 2002; Robinson 2003a, 2003b; Robinson et al. 1997, 1998, 2001a, 2001b, 2002, 2003a, 2003b, 2004; Rowe et al. 2004; Steriade et al. 1990; Wilson and Cowan 1973; Wright and Liley 1996). These models readily include measurement effects such as the volume conduction that spatially smooths EEG signals, and hemodynamic responses that temporally filter functional MRI signals. Neural-field theories thus average over microstructure to yield field equations that complement cellular-level and neural-network analyses.

Essential features of a realistic neurodynamic model are that it: (i) be based on physiology and anatomy, including salient features at many spatial and temporal scales, (ii) be quantitative with predictions that can be calculated analytically or numerically, including measurement effects, (iii) have parameters that relate directly to physiology and anatomy, and can be estimated in independent experiments, (iv) be applicable to multiple phenomena and data types, rather than being a theory of a single phenomenon or type of experiment, and (v) be invertible, if possible, allowing parameters to be deduced by fitting model predictions to data (these must be consistent with independent measurements). These criteria rule out highly idealized models of abstract neurons, models tailored to single phenomena, models with completely free parameters, and models that ignore measurement effects.

We have developed a physiologically based neural-field model of brain dynamics that satisfies the above criteria. When applied to the corticothalamic system, it reproduces and unifies many features of EEGs, including spectral peaks seen in waking and sleeping states (Robinson et al. 1997, 2001b, 2004), evoked potentials (Rennie et al. 2002), correlation and coherence functions (O'Connor and Robinson 2003; O'Connor et al. 2002; Robinson 2003a, 2003b), epileptic seizure dynamics (Breakspear et al. 2006; Robinson et al. 2002), Parkinsonian activity (van Albada and Robinson 2009; van Albada et al. 2009b), parameter determination (Robinson et al. 2004; Rowe et al. 2004; van Albada et al. 2009a; Phillips and Robinson 2007, 2008), and sleep-wake dynamics in the ascending arousal system (Phillips and Robinson 2007, 2008; Fulcher et al. 2008, 2010).

In Sect. 3.2 we outline our model, including its physiological and anatomical foundations, basic predictions, and its connection to measurements. In Sects. 3.3 and 3.4 we then discuss a range of predictions of brain dynamics and compare them with experimental data. Section 3.5 summarizes and discusses the material.

3.2 Neural-Field Theory

Here we briefly review our model and its connections with measurable quantities. Further discussion and generalizations are found elsewhere (Rennie et al. 1999, 2002; Robinson 2005, 2006; Robinson et al. 1997, 2010).

3.2.1 Neural-Field Modeling

The brain contains multiple populations of neurons, which we distinguish by a subscript a that designates both the structure in which a given population lies (e.g., a particular nucleus) and the type of neuron (e.g., interneuron, pyramidal cell). We average their properties over scales of order 0.1 mm and seek equations for the resulting mean-field quantities.

The mean soma potential $V_a(\mathbf{r}, t)$ relative to resting is approximated as the sum of contributions $V_{ab}(\mathbf{r}, t)$ arriving as a result of activity at each type of (mainly)

dendritic synapse b , where b denotes both the population and neurotransmitter type, \mathbf{r} denotes the spatial location, and t the time. This gives

$$V_a(\mathbf{r}, t) = \sum_b V_{ab}(\mathbf{r}, t). \quad (3.1)$$

The potential V_{ab} is generated when synaptic inputs from afferent neurons are temporally low-pass filtered and smeared out in time as a result of receptor dynamics, passage through the dendritic tree, and soma charging. The resulting soma response approximately obeys the differential equation (Robinson 2005; Robinson et al. 1997, 2001b, 2004)

$$D_{ab} V_{ab}(\mathbf{r}, t) = N_{ab} s_{ab} \phi_b(\mathbf{r}, t - \tau_{ab}), \quad (3.2)$$

$$D_{ab} = \frac{1}{\alpha_{ab} \beta_{ab}} \frac{d^2}{dt^2} + \left(\frac{1}{\alpha_{ab}} + \frac{1}{\beta_{ab}} \right) \frac{d}{dt} + 1, \quad (3.3)$$

where $1/\beta_{ab}$ and $1/\alpha_{ab}$ are rise and decay times of the cell-body potential produced by impulse at a dendritic synapse. The right of (3.2) describes the influence of the firing rates ϕ_b from neuronal populations b , in general delayed by a time τ_{ab} due to discrete anatomical separations between different structures, where N_{ab} is the mean number of synapses on neurons of type a from type b and s_{ab} is the time-integrated response in neurons a to a unit signal from neurons b . Here we do not model explicit dynamics of s_{ab} , driven by neuromodulators, plasticity, and similar effects; such dynamics can be incorporated straightforwardly (Clearwater et al. 2007; Rennie et al. 1999; Robinson 2011, submitted).

Action potentials are produced at the axonal hillock when V_a exceeds a threshold. In effect, V_a acts as a control variable for the fast spike dynamics, and is proportional to the applied current of single-neuron experiments (Robinson et al. 2008). Spikes in most cortical cells arise via a saddle-node bifurcation in a set of Hodgkin–Huxley-like equations for ionic currents (Wilson 1999) and are produced only for V_a above an individual threshold $\tilde{\theta}_a$, at a mean rate $Q_a \propto (V_a - \tilde{\theta}_a)^{1/2}$, at low Q_a (Strogatz 1994), leveling off due to saturation effects at higher V_a (Wilson 1999). Individual cells differ from the mean in the number and strength of ion channels, and hence in $\tilde{\theta}_a$, and fluctuations in V_a also exist, so the response must be modified to include saturation and convolved with a distribution of individual deviations. These steps yield the population-average response function

$$Q_a(\mathbf{r}, t) = S[V_a(\mathbf{r}, t)], \quad (3.4)$$

$$= \frac{Q_{\max}}{1 + \exp\{-[V_a(\mathbf{r}, t) - \theta]/\sigma'\}}, \quad (3.5)$$

where Q_{\max} is the maximum firing rate, θ is the mean neural firing threshold, and $\sigma'\pi/\sqrt{3}$ is its standard deviation (here these quantities are assumed to be the same for all populations). In the linear regime, we make the approximation

$$Q_a(\mathbf{r}, t) = \rho_a V_a(\mathbf{r}, t), \quad (3.6)$$

where ρ_a is the derivative of the sigmoid at an assumed steady state of the system (we discuss the existence and stability of such states below).

Each neuronal population a within the corticothalamic system produces a field ϕ_a of pulses that travels to other neuronal populations at a velocity v_a through axons with a characteristic range r_a (more generally, these quantities can depend on both a and b (Robinson 2005)). These pulses spread out and dissipate if not regenerated. To a good approximation, axonal propagation obeys the damped wave equation (Jirsa and Haken 1996; Nunez 1995; Robinson et al. 1997)

$$\mathcal{D}_a \phi_a(\mathbf{r}, t) = S[V_a(\mathbf{r}, t)], \quad (3.7)$$

$$\mathcal{D}_a = \left(\frac{1}{\gamma_a^2} \frac{\partial^2}{\partial t^2} + \frac{2}{\gamma_a} \frac{\partial}{\partial t} + 1 - r_a^2 \nabla^2 \right) \phi_a(\mathbf{r}, t), \quad (3.8)$$

where the damping coefficient is $\gamma_a = v_a/r_a$. Equations (3.7) and (3.8) yield propagation ranges in good agreement with anatomical results (Braitenberg and Schüz 1991) and with other phenomena.

Equations (3.1)–(3.3), (3.4), (3.5), (3.7), and (3.8) form a closed nonlinear set, which can be solved numerically, or studied analytically in appropriate limits (see Sect. 3.3). Once a set of specific neural populations has been chosen, and physiologically realistic values have been assigned to their parameters, these equations can be used to predict neural activity. These equations govern spatiotemporal dynamics of firing rates, not of the individual spike dynamics. The two are closely correlated, but the nonlinearities of our equations are weaker than those that produce the spikes themselves, in that they only produce effects on much longer timescales than those of spikes. We thus stress that the oscillations predicted from our equations are collective oscillations of the rate of spiking, whose frequencies are not usually equal to the spike rate itself—a common misunderstanding of neural-field models.

3.2.2 Measurements

Once neural activity has been predicted from stimuli, one must relate it to measurements to interpret experimental results. The limited spatiotemporal resolution of such measurements often provides an additional justification for the use of neural-field modeling, since finer-scale structure is not resolvable.

In the case of EEG measurements, the effects of volume conduction on the propagation of neural potential changes to the scalp have been incorporated into our model, via attenuation and spatial filtering parameters (O’Connor et al. 2002; Robinson et al. 2001b, 2004; Rowe et al. 2004). These are included in the bulk of the results reviewed here; space limitations preclude a detailed discussion, but their effects on spectral shape, for example, are slight at frequencies below about 20 Hz, since these correspond to the longest wavelengths. We have also shown how to include the effects of reference electrode and multielectrode derivations (Henderson et al. 2006; Robinson 2003a). It should also be noted that scalp potentials are primarily generated by excitatory (mainly pyramidal) neurons owing to their greater size and degree of alignment compared to other types (Nunez 1995; Nunez and Srinivasan 2006; O’Connor and Robinson 2003; Rennie et al. 2002). In the linear regime at least, the

scalp potential is proportional to the cortical potential, which is itself proportional to the mean cellular membrane currents, which are in turn proportional to ϕ_e . Hence, apart from a (dimensional) constant of proportionality, and the spatial low-pass filtering effects of volume conduction, scalp EEG signals correspond to ϕ_e to a good approximation in the linear domain (Robinson et al. 2003b).

3.3 Corticothalamic Model

Much work has been done on applications of mean-field theory to cortical and corticothalamic systems. Here we consider the latter because inclusion of the thalamus has been found to be essential to reproduce a wide range of phenomena at typical EEG frequencies.

3.3.1 Corticothalamic Connectivities

Figure 3.2 shows the large-scale structures and connectivities incorporated in the model, including the thalamic reticular nucleus r , which inhibits relay (or *specific*) nuclei s (Sherman and Guillery 2001; Steriade et al. 1997). Relay nuclei convey external stimuli ϕ_n to the cortex, as well as passing on corticothalamic feedback. In this section we consider long-range excitatory cortical neurons ($a = e$), short-range mainly inhibitory cortical neurons ($a = i$), neurons in the reticular nucleus of the thalamus ($a = r$), neurons of thalamic relay nuclei ($a = s$), and external inputs ($a = n$) from non-corticothalamic neurons.

A point that is sometimes mistaken in the literature is that mean-field models do not need to divide the cortex into discrete pieces. In particular, there is no need to divide the cortex into hypercolumns, and this is actually likely to be a poor approximation, especially if it is implemented in a way that imposes sharp hypercolumn

Fig. 3.2 More detailed schematic of corticothalamic interactions from Fig. 3.1, showing the locations at which the v_{ab} of (3.9) and linear gains G_{ab} act, where $c, c' = e, i$ denote cortical quantities (Robinson et al. 2010)

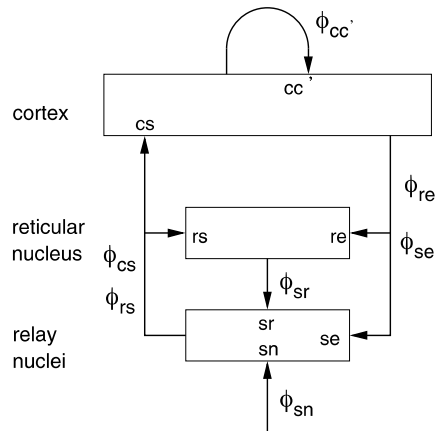

boundaries, since no such boundaries exist in nature (Horton and Adams 2005). A related misunderstanding in the literature is the idea that short-range and long-range interactions must be treated by different means. This is often encapsulated in a division into short-range connections within hypercolumns and long-range cortico-cortical connections between hypercolumns. In fact, all connections can be handled using the same approach, with different ranges simply incorporated via separate neural populations with different axonal range parameters r_a (Robinson 2005).

3.3.2 Corticothalamic Parameters

If intracortical connectivities are proportional to the numbers of neurons involved—the *random connectivity approximation*—and $s_{ib} = s_{eb}$, $L_{ib} = L_{eb}$ for each b , then $V_i = V_e$ and $Q_i = Q_e$ (Robinson et al. 1997; Wright and Liley 1996), which lets us concentrate on excitatory quantities, with inhibitory ones derivable from them (inhibition is *not* neglected in this approximation). The short range of i neurons and the small size of the thalamic nuclei enables us to set $r_a \approx 0$ and, hence, $\gamma_a \approx \infty$ for $a = i, r, s$. The only nonzero discrete delays are $\tau_{es} = \tau_{se} = \tau_{re} = t_0/2$, where t_0 is the time for signals to pass from cortex to thalamus and back again. We also assume that all the synaptodendritic time constants are equal, for simplicity, and set $\alpha_{ab} = \alpha$ and $\beta_{ab} = \beta$ for all a and b in what follows; this allows us to drop the subscripts ab in (3.2) and (3.3) and write D_α in place of D_{ab} .

Including only the connections shown in Fig. 3.2 and making the above approximations, our nonlinear model has 16 parameters (not all of which appear separately in the linear limit). By defining

$$v_{ab} = N_{ab}s_{ab}, \quad (3.9)$$

these parameters are Q_{\max} , θ , σ' , α , β , γ_e , r_e , t_0 , v_{ee} , v_{ei} , v_{es} , v_{se} , v_{sr} , v_{sn} , v_{re} , and v_{rs} . These are sufficient in number to allow adequate representation of the most important anatomy and physiology, but few enough to yield useful interpretations and to enable reliable determination of values by fitting theoretical predictions to data. The parameters are approximately known from experiment (Robinson 2005, 2006; Robinson et al. 2001b, 2004; Rowe et al. 2004) leading to the indicative values in Table 3.1, which are all compatible with physiology. Sensitivities of the model to parameter variations have been explored in general (Robinson et al. 2001b) and in connection with variations between sleep, wake, and other states (Robinson et al. 2002). Because normal sleep and wake are global brain phenomena, we concentrate on results for which the model parameters are assumed to be spatially uniform, but where the activity is free to be nonuniform; generalization to include spatial parameter dependences is straightforward (Robinson et al. 2003b).

An important implication of the parameters above is that the corticothalamic loop delay t_0 places any oscillations that involve this loop at frequencies of order 10 Hz. This means that inclusion of the thalamus and the dynamics of these loops is essential to understand phenomena at frequencies below circa 20 Hz. At very low

Table 3.1 Indicative parameters for the alert, eyes-open state in normal adults (Robinson et al. 2004). Parameters used in the figures in this chapter are similar, but not always identical

Quantity	Nominal	Unit
Q_{\max}	340	s^{-1}
v_e	10	m s^{-1}
r_e	86	mm
θ	13	mV
σ'	3.8	mV
γ_e	116	s^{-1}
α	80	s^{-1}
β	500	s^{-1}
t_0	85	ms
v_{ee}	1.6	mV s
$-v_{ei}$	1.9	mV s
v_{es}	0.4	mV s
v_{se}	0.6	mV s
$-v_{sr}$	0.45	mV s
v_{sn}	0.2	mV s
v_{re}	0.15	mV s
v_{rs}	0.03	mV s
$\phi_n^{(0)}$	16	s^{-1}

frequencies ($\ll 10$ Hz) it is sufficient to include a static corticothalamic feedback strength to the cortex, and at very high frequencies ($\gg 10$ Hz) the corticothalamic feedback is too slow to affect the dynamics strongly. As we will see in the next section, thalamic effects dominate much of the dynamics at intermediate frequencies.

3.3.3 Dynamical Equations

Using (3.1)–(3.3), the above connectivities and parameters imply

$$D_\alpha V_e(t) = v_{ee}\phi_e(t) + v_{ei}\phi_i(t) + v_{es}\phi_s(t - t_0/2), \quad (3.10)$$

$$D_\alpha V_i(t) = v_{ee}\phi_e(t) + v_{ei}\phi_i(t) + v_{es}\phi_s(t - t_0/2), \quad (3.11)$$

$$D_\alpha V_r(t) = v_{re}\phi_e(t - t_0/2) + v_{rs}\phi_s(t), \quad (3.12)$$

$$D_\alpha V_s(t) = v_{se}\phi_e(t - t_0/2) + v_{sr}\phi_r(t) + v_{sn}\phi_n(t), \quad (3.13)$$

whence $V_i = V_e$ and $Q_i = Q_e$, as asserted above. The right sides of (3.10)–(3.13) describe, for each population, the sum of all afferent activity (including via self-connections), and D_α describes the temporal dynamics. The short ranges of the axons i , r , and s imply that $D_\alpha \approx 1$ for these populations, giving

$$\phi_a = Q_a = S(V_a), \quad (3.14)$$

for $a = i, r, s$. For the remaining e population, (3.7) and (3.8) yield

$$\left(\frac{1}{\gamma_e^2} \frac{\partial^2}{\partial t^2} + \frac{2}{\gamma_e} \frac{\partial}{\partial t} + 1 - r_e^2 \nabla^2 \right) \phi_e(\mathbf{r}, t) = S[V_e(\mathbf{r}, t)], \quad (3.15)$$

with $\gamma_e = v_e/r_e$. Equations (3.10)–(3.15) describe our corticothalamic model.

3.3.4 Steady States

We find spatially uniform steady states of our system by setting all the spatial and temporal derivatives to zero in (3.10)–(3.15). The resulting equations can be rearranged to yield a single equation for the steady-state value of ϕ_e (Robinson et al. 2004):

$$0 = S^{-1}(\phi_e^{(0)}) - (v_{ee} + v_{ei})\phi_e^{(0)} - v_{es}S\left(v_{se}\phi_e^{(0)} + v_{sn}\phi_n^{(0)} + v_{sr}S\left[v_{re}\phi_e^{(0)} + \frac{v_{rs}}{v_{es}}\{S^{-1}(\phi_e^{(0)}) - (v_{ee} + v_{ei})\phi_e^{(0)}\}\right]\right), \quad (3.16)$$

where S^{-1} denotes the inverse of the sigmoid function S . The function on the right of (3.16) is continuous and approaches $-\infty$ as $\phi_e^{(0)} \rightarrow 0$ and $+\infty$ as $\phi_e^{(0)} \rightarrow Q_{\max}$. Hence, it has an odd number of zeros, usually one or three (five are possible in narrow parameter ranges). Addition of neuromodulatory feedbacks on synaptic strengths s_{ab} in (3.9) can increase the number of zeros and broaden parameter ranges where five or more are possible (Clearwater et al. 2007). We consider the main case of three zeros for now.

When there are three zeros, one stable zero occurs at low $\phi_e^{(0)}$, and we identify this as the baseline activity level of normal brain function. The other stable zero is at high $\phi_e^{(0)}$ with all neurons firing near to their physiological maximum. This would thus represent a seizure state, but would require further physiology (e.g., of hypoxia at high activity levels) to be treated adequately. The states are shown in Fig. 3.3, where they are linked by the unstable fixed point to form a “fold.” It should be noted that purely cortical sleep models have variously postulated that a similar pair of stable states represents anesthesia/sleep, sleep/wake, or non-REM sleep/REM sleep, often using parameters that lower $\phi_e^{(0)}$ in the upper state to acceptable levels (Steyn-Ross et al. 1999, 2005, 2006). However, they do not seem to have made a self-consistent identification of cases with branches to unify them, and purely cortical models also leave out the central roles of the thalamus and ascending arousal system (see Fig. 3.1 and Sect. 3.4).

3.3.5 Transfer Functions and Linear Waves

Small perturbations relative to steady states can be treated using linear analysis. A stimulus $\phi_n(\mathbf{k}, \omega)$ of angular frequency ω ($= 2\pi f$, where f is the frequency in

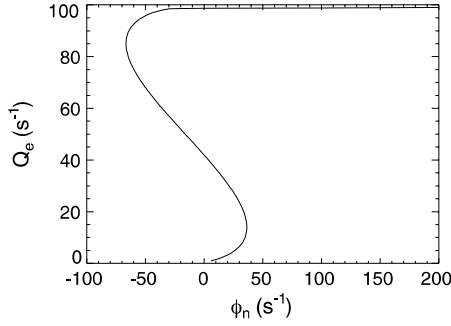

Fig. 3.3 Q_e vs ϕ_n , showing the stable states with low firing rates ($<15 \text{ s}^{-1}$) and with firing rates near saturation ($>85 \text{ s}^{-1}$). These two branches are linked by an unstable branch to form a “fold”. Note that the negative steady-state values of ϕ_n in the figure can be physical, provided this variable includes inhibitory neuromodulation in addition to tonic sensory activity

Hz) and wave vector \mathbf{k} ($= 2\pi/\lambda$ in magnitude, where λ is the wavelength) has the transfer function to $\phi_e(\mathbf{k}, \omega)$

$$\frac{\phi_e(\mathbf{k}, \omega)}{\phi_n(\mathbf{k}, \omega)} = \frac{G_{es}L}{1 - G_{ei}L} \frac{G_{sn}L e^{i\omega t_0/2}}{1 - G_{srs}L^2} \frac{1}{q^2(\omega)r_e^2 + k^2r_e^2}, \quad (3.17)$$

$$q^2(\omega)r_e^2 = (1 - i\omega/\gamma_e)^2 - \frac{L}{1 - G_{ei}L} \left[G_{ee} + \frac{(G_{ese} + G_{esre}L)L}{1 - G_{srs}L^2} e^{i\omega t_0} \right], \quad (3.18)$$

$$G_{ab} = \frac{\phi_a^{(0)}}{\sigma'} \left(1 - \frac{\phi_a^{(0)}}{Q_{\max}} \right) v_{ab}, \quad (3.19)$$

where $L = (1 - i\omega/\alpha)^{-1}(1 - i\omega/\beta)^{-1}$ embodies the low-pass filter characteristics of synaptodendritic dynamics and $\phi_a^{(0)}$ is the steady-state value of ϕ_a . The transfer function (3.17) is the cortical excitatory response per unit external stimulus, and encapsulates the relative phase via its complex value (Rennie et al. 2002; Robinson 2005; Robinson et al. 2001b); it is the key to linear properties of the system. The gain G_{ab} is the differential output produced by neurons a per unit change in input from neurons b , and the static gains for loops in Fig. 3.2 are $G_{ese} = G_{es}G_{se}$ for feedback via relay nuclei only, $G_{esre} = G_{es}G_{sr}G_{re}$ for the loop through reticular and relay nuclei, and $G_{srs} = G_{sr}G_{rs}$ for the intrathalamic loop.

Waves obey the dispersion relation (Robinson et al. 1997)

$$q^2(\omega) + k^2 = 0, \quad (3.20)$$

which corresponds to singularity of the transfer function (3.17). Solutions of this equation satisfy $\omega = kv_e - i\gamma_e$ at high frequencies (Robinson et al. 1997).

3.3.6 Spectra and Instabilities

The EEG frequency spectrum is obtained by squaring $|\phi_e(\mathbf{k}, \omega)|$ and integrating (or summing for discrete modes) over \mathbf{k} , giving

$$P_e(\omega) = \int \left| \frac{\phi_e(\mathbf{k}, \omega)}{\phi_n(\mathbf{k}, \omega)} \right|^2 |\phi_n(\mathbf{k}, \omega)|^2 d^2\mathbf{k}. \quad (3.21)$$

If we make the assumption that under conditions of spontaneous EEG the field of external stimuli $\phi_n(\mathbf{k}, \omega)$ is so complex that it can be approximated by spatiotemporal white noise, this gives $|\phi_n(\mathbf{k}, \omega)|^2 = \text{constant}$, whence

$$P_e(\omega) = \frac{\langle \phi_n^2 \rangle}{4\pi r_e^4} \left| \frac{G_{esn} L^2}{(1 - G_{ei} L)(1 - G_{srs} L^2)} \right|^2 \frac{\text{Arg } q^2}{\text{Im } q^2}, \quad (3.22)$$

where $\langle \phi_n^2 \rangle$ is the mean-square noise level. Figure 3.4(a) shows excellent agreement of (3.22) with an observed spectrum over several decades. The features reproduced include the alpha and beta peaks at frequencies $f \approx 1/t_0, 2/t_0$, and the asymptotic low- and high-frequency behaviors; key differences between waking and sleep spectra can also be reproduced, including the strong increase in low-frequency activity in sleep, where our model predicts a steepening of the spectrum from $1/f$ toward $1/f^3$, as seen in Fig. 3.4(b) and discussed further below (Robinson et al. 2001b). Each of the features can be related to underlying anatomy and physiology: Low-frequency $1/f$ or $1/f^3$ behavior is a signature of marginally stable, near-critical dynamics, which allow complex behavior (Robinson et al. 1997, 2001b, 2002), while the steep high-frequency fall-off results from low-pass filtering by synaptodendritic dynamics. Corticothalamic loop resonances account for the alpha and beta peaks, their relative frequencies, the correlated changes in spectral peaks between sleep and waking, and splitting of the alpha peak in a large proportion of normal subjects [see Fig. 3.4(b)], for example (Robinson et al. 2001b, 2002, 2003b). Proposed alternatives, including “pacemakers” and purely cortical resonances, can account for some features of the data, but the trend in mode frequency predicted for purely cortical eigenmodes is likely to be in the opposite direction to that observed. Likewise, the pacemaker hypothesis is ad hoc, with a new pacemaker proposed for every spectral peak (Nunez 1995; Robinson et al. 2001a, 2003b). Overall, the evidence is now strong that the thalamus must be included to account for most salient EEG features at frequencies below about 20 Hz, as underlined by the ability of the resulting theory to simultaneously account for the wide range of phenomena mentioned in Sect. 3.1.

Linear waves obey the dispersion relation (3.20), with instability boundaries occurring where this equation is satisfied for real ω (Robinson et al. 1997, 2001b, 2002). In most circumstances, waves with $k = 0$ (i.e., spatially uniform) are the most unstable (Robinson et al. 1997), and it is found that only the first few (i.e., lowest frequency) spectral resonances can become unstable. Analysis of stability of perturbations relative to the steady state that represents normal activity for realistic parameter ranges finds just four $k = 0$ instabilities, leading to global nonlinear dynamics (Breakspear et al. 2006; Robinson et al. 2002, 2003a): (a) Slow-wave instability ($f \approx 0$) via a saddle-node bifurcation that leads to a low-frequency spike-wave

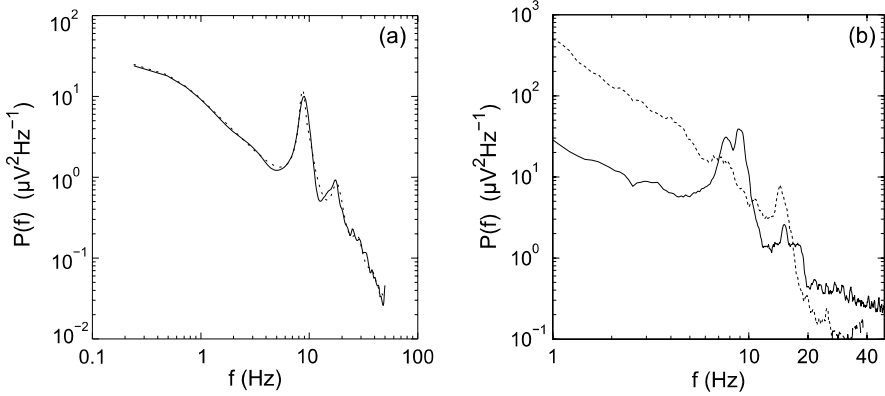

Fig. 3.4 Exemplar spectra. (a) Experimental spectrum (*solid*) and model fit (*dashed*) from a typical adult subject in the eyes-closed (EC) state (Robinson et al. 2002). (b) Spectra for EC (*solid*) and sleep stage 2 (*dashed*), the latter showing approximately $1/f^2$ dependence at low f , which steepens further in stages 3 and 4

limit cycle, (b) theta instability, via a supercritical Hopf bifurcation that saturates in a nonlinear limit cycle near 3 Hz, with a spike-wave form, interpreted as an absence seizure (Breakspear et al. 2006; Robinson et al. 2002, 2003a), (c) alpha instability, via a subcritical Hopf bifurcation, giving a limit cycle near 10 Hz, interpreted as a tonic-clonic seizure (Breakspear et al. 2006; Robinson et al. 2002, 2003a), and (d) spindle instability at $\omega \approx (\alpha\beta)^{1/2}$, leading to a limit cycle at 10–15 Hz (the nature of this bifurcation has not yet been fully investigated).

At low frequencies the state and physical stability of the corticothalamic system can approximately be represented in a 3D space with axes

$$x = G_{ee}/(1 - G_{ei}), \quad (3.23)$$

$$y = (G_{ese} + G_{esre})/[(1 - G_{srs})(1 - G_{ei})], \quad (3.24)$$

$$z = -G_{srs}\alpha\beta/(\alpha + \beta)^2, \quad (3.25)$$

which parameterize cortical, corticothalamic, and thalamic stability, respectively (Breakspear et al. 2006; Robinson et al. 2002). In terms of these quantities, parameters corresponding to linearly stable brain states lie in a stability zone illustrated in Fig. 3.5. The back is at $x = 0$ and the base at $z = 0$. A pure spindle instability occurs at $z = 1$, which couples to the alpha instability, with spindle dominating at top and left, and alpha at right. At small z , the left surface is defined by a theta instability (Breakspear et al. 2006; Robinson et al. 2002). The front right surface corresponds to slow-wave instability at $x + y = 1$. Normal brain states lie within the stability zone. Detailed arguments regarding the sign of feedback via the thalamus, proximity between neighboring behavioral states, and the results of explicit fitting to data (enabled by the present model), place the arousal sequence, from alert eyes-open (EO) to deep sleep, including relaxed eyes-closed (EC) and sleep stages 1–4 (S1–S4), as shown in Fig. 3.5(a), corresponding to the typical time series in Fig. 3.5(b) (Robinson et al. 2002).

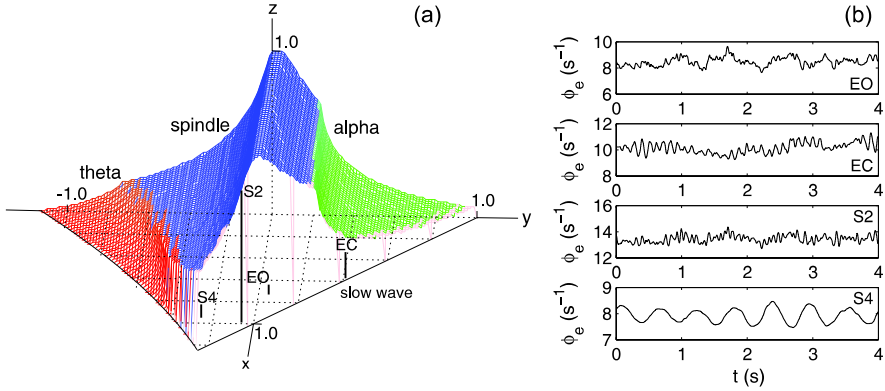

Fig. 3.5 Brain stability and time series. **(a)** Stability zone (Robinson et al. 2002). The surface is shaded according to instability, as labeled (*blue* = spindle, *green* = alpha, *red* = theta), with the front right-hand face left transparent as it corresponds to a slow-wave instability. Approximate locations are shown of alert eyes-open (EO), relaxed, eyes-closed (EC), sleep stage 2 (S2) and 4 (S4) states, with each state located at the top of its bar, whose x - y coordinates can be read from the grid. **(b)** Simulated time series corresponding to EO, EC, S2, and S4, approximating sensory inputs as white noise (Robinson et al. 2002)

Each of the above instabilities corresponds to a point where the imaginary part of the dispersion solution ω changes sign, leading to exponential growth away from the fixed point. Corresponding spectral changes at low frequencies can be examined by expanding the quantity $q^2 r_e^2$ in (3.22) in powers of $-i\omega$:

$$q^2 r_e^2 = A_0 + A_1(-i\omega) + A_2(-i\omega)^2 + A_3(-i\omega)^3 + \dots, \quad (3.26)$$

where the A_j are constants that can be expressed in terms of the physiological parameters of the model (Robinson et al. 1997, 2002). The saddle-node bifurcation where $A_0 = 0$ [$x + y = 1$ in terms of the quantities in (3.23)–(3.25)] is thus marked by a spectral divergence at $f = 0$, giving a $1/f$ spectrum at low f and long-range correlations and coherence. A $1/f^3$ spectrum at low f results when $A_0 = 0$ and $A_1 = 0$ simultaneously [the latter corresponding to $y \approx -2(1 - G_{srS})/(\gamma_e t_0)$ for parameter values from Table 1], thereby accounting for steeper spectra such as that seen in Fig. 3.4(b).

3.4 Neural-Field Model of Arousal

Wake-sleep transitions of the brain are mainly governed by the nuclei of the ascending arousal system (AAS) of the brainstem and hypothalamus, which project diffusely to the corticothalamic system. As we will see shortly, the AAS network can also undergo instabilities. Hence, a full description of both sleep-wake transitions and their EEG correlates requires an integrated model of the ascending arousal system and the corticothalamic system (at least), including their mutual interactions.

Here we describe how the nuclei of the ascending arousal system (AAS) are modeled using the same methods as above, review some of the main results to date, and outline steps toward integrating the AAS and corticothalamic models.

3.4.1 Ascending Arousal System Model

The most important nuclei to model in the AAS are well established from detailed physiological investigations, and are shown in the green block in Fig. 3.1. These include the monoaminergic (MA) group and the ventrolateral preoptic nucleus (VLPO), which mutually inhibit one another, resulting in flip-flop dynamics if the interaction is sufficiently strong—only one can be active at a time, and it suppresses the other (Saper et al. 2001). During wake, the MA group is dominant, while the VLPO is dominant in sleep. Transitions between states are driven by inputs to the VLPO, which include the circadian drive C from the suprachiasmatic nucleus (SCN) (mainly as a result of light exposure), and the homeostatic sleep drive H arising from buildup of metabolic byproducts (mostly adenosine, but possibly including other somnogens) during wake, and their clearance during sleep. There is also an input to the MA group from cholinergic (ACh), as shown (Pace-Schott and Hobson 2002; Saper et al. 2001).

Until recently, models of AAS dynamics have been either nonmathematical (e.g., based on sleep diaries or qualitative considerations) or abstract (mathematical, but not derived directly from physiology). The widely known *two-process model* is of the latter form, and includes circadian and homeostatic influences (Achermann and Borbély 2003). In this section, we use the methods of Sects. 3.2 and 3.3 to model the dynamics of the AAS nuclei (Phillips and Robinson 2007). Several simplifications and approximations are appropriate: the nuclei are small, so $r_a \approx 0$ and $\gamma_a \rightarrow \infty$ in (3.8), implying that (3.14) applies for these nuclei. (In this limit, neural-field theory reduces to neural-mass theory, in which each population is treated as a lumped mass (Freeman 1975; Deco et al. 2008)). Also, since the transitions take place on timescales of many seconds to minutes, first-order in time versions of (3.3) can be used. We also assume that (i) since the system spends little time in transitions, the generation rate of H has just two values, one for wake and one for sleep, (ii) that the clearance rate of H is proportional to H , and (iii) the variation of C can be approximated as sinusoidal. These steps yield

$$\tau \frac{dV_v}{dt} + V_v = v_{vm} Q_m + D, \quad (3.27)$$

$$\tau \frac{dV_m}{dt} + V_m = v_{mv} Q_v + A, \quad (3.28)$$

$$\chi \frac{dH}{dt} + H = \mu Q_m, \quad (3.29)$$

$$C = c_0 + \cos(\Omega t), \quad (3.30)$$

$$D = v_{vc} C + v_{vh} H, \quad (3.31)$$

Table 3.2 Nominal parameter values for the ascending arousal system model

Quantity	Nominal	Unit
$-v_{vc}$	2.9	mV
v_{vh}	1.0	mV nM ⁻¹
χ	45	h
μ	4.4	nM s
c_0	4.5	–
Q_{\max}	100	s ⁻¹
θ	10	mV
σ'	3	mV
A	1.3	mV
$-v_{vm}$	2.1	mV s
$-v_{mv}$	1.8	mV s
τ	10	s

with (3.14) and where the time constants τ of the nuclear responses have been assumed equal [these replace $1/\alpha$ in (3.3), with $\beta \rightarrow \infty$ formally], χ is the somnogen clearance time, v denotes the VLPO, m denotes MA nuclei, the v_{ab} , V_a , and Q_a have the same meanings as in previous sections, μ gives the proportionality between MA activity and somnogen generation rate, the amplitude of the C cycle is absorbed into v_{vc} so it is set to unity in (3.30), and $\Omega = 2\pi/(1 \text{ day})$.

Our AAS model has 12 physiological parameters— τ , χ , v_{vm} , v_{mv} , A , μ , c_0 , v_{vc} , v_{vh} , Q_{\max} , θ , and σ' , whose nominal values are given in Table 3.2, as determined by a combination of physiological constraints from the literature, and comparison of the dynamics with behavior in a restricted set of sleep experiments on normal sleep and sleep deprivation (Phillips and Robinson 2007, 2008). The theory then predicts phenomena in regimes outside those of the calibration experiments.

3.4.2 Normal Sleep Dynamics

The first key result from the model in Sect. 3.4.1 is that the steady states of (3.27)–(3.31) display a “fold” as a function of the total drive D . The upper and lower branches represent wake and sleep, respectively, with an unstable branch in between. Cyclic variations in D cause the system to move around the hysteresis loop shown in Fig. 3.6, with saddle-node bifurcations from wake to sleep and back again. The two stable branches are separated by an unstable state, and near-stable *ghost* states are located just beyond saddle-node bifurcations of the wake and sleep states, respectively.

3.4.3 Sleep Deprivation and Recovery

This model has been applied to study the effects of total sleep deprivation and recovery, including the typical time course of recovery sleep and the recovery of sleep

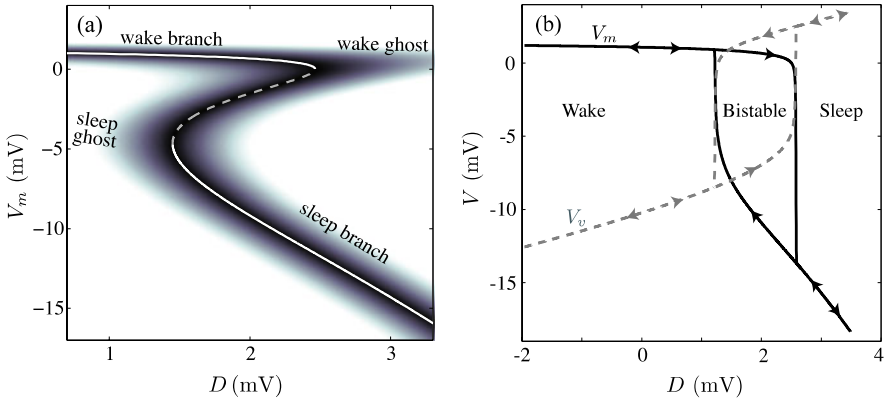

Fig. 3.6 Sleep dynamics. (a) Stable wake and sleep branches are linked by an unstable branch (dashed). Wake and sleep ghosts are also shown. Shading indicates regions of small $|\dot{V}_m|$. (b) Plot of V_m versus the sleep drive D across a 24 h period. As D oscillates with a 24 h period, arrows show how V_m cycles (as does V_v) around its hysteresis loop between wake and sleep states. Figure adapted from Fulcher et al. (2008)

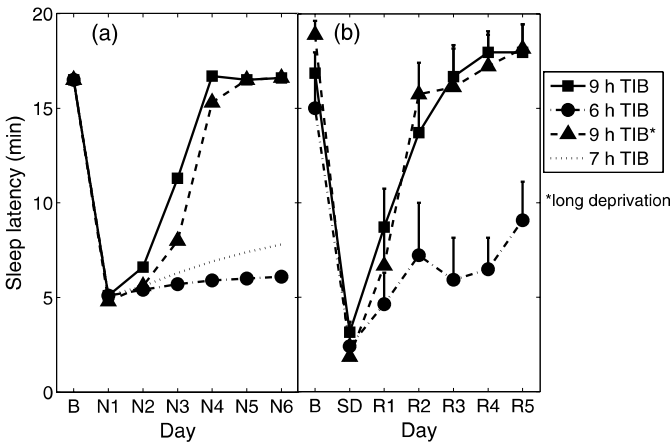

Fig. 3.7 Sleep latencies following deprivation for (a) model simulations, and (b) experimental data (showing mean \pm SEM), adapted from (Phillips and Robinson 2008). Triangles are for 9 h time in bed (TIB) following 63 h sleep deprivation. All other curves are after 39 h sleep deprivation, with 9 h TIB (squares), 6 h TIB (circles), plus 7 h TIB (dotted), for which there are no comparable experimental data. In (a) sleep latencies are measured at the end of each day, for baseline (B), and each night of recovery (N1, N2, etc.). In (b) latencies are measured across the day for baseline (B), during deprivation (SD), and during each recovery day (R1, R2, etc.). Data in (b) are adapted from Lamond et al. (2007)

latency times to baseline levels, as shown in Fig. 3.7 (Phillips and Robinson 2008). The model also predicts that initiating sleep near the normal bed time minimizes the total amount of recovery sleep required (Phillips and Robinson 2008).

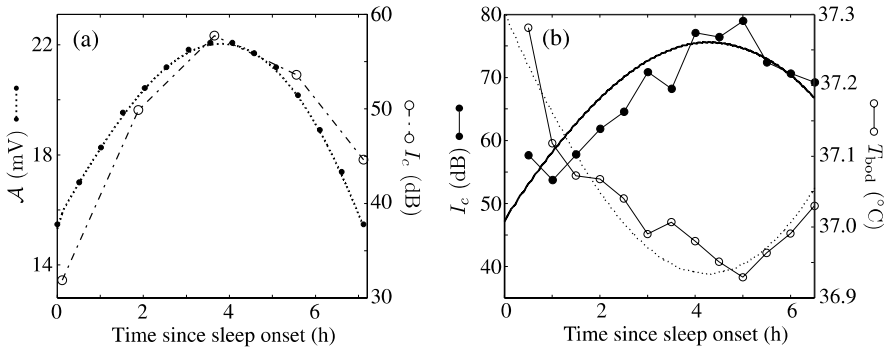

Fig. 3.8 Model predictions of the arousal threshold (Fulcher et al. 2010). (a) The model’s arousal threshold \mathcal{A} (mV) shows good agreement with experimental values of the auditory arousal threshold I_c (dB) measured across a normal night of sleep (Bonnet et al. 1979). (b) The model also predicts the arousal threshold while simulating a sleep fragmentation study (Lammers et al. 1991), and simultaneously predicts the body temperature from a linear scaling of the sleep drive D . Data are shown with *circles*; model predictions are *curves*

3.4.4 Stimuli

The impact of external stimuli, to either the MA or the VLPO, can be modeled as perturbations on the model drives (Fulcher et al. 2008). In particular, since sensory stimuli are known to excite the MA (Berridge and Waterhouse 2003), they can be modeled with an additional term ΔD_m on the right of (3.28). The dynamics of the model’s excursion from equilibrium can therefore be interpreted as an arousal state response to a stimulus. One application of this approach is to sleep fragmentation, in which auditory stimuli are applied to sleeping subjects to simulate the frequent brief awakenings caused by sleep apneas (Stepanski 2002). Excitatory stimuli ΔD_m perturb the system from the sleep branch to higher V_m [a ‘vertical’ perturbation in Fig. 3.6(a)]. The wake ghost in Fig. 3.6(a) is crucial to the dynamics in this regime. For small impulses, the system returns quickly to the sleep branch, but if the impulse is large enough, the return is via the wake ghost where the system lingers for an extended period, representing a brief awakening (Fulcher et al. 2008). The influence of the wake ghost on the dynamics therefore motivates a definition of the arousal threshold as the magnitude of the drive $|\Delta D_m|$ required to perturb the system to the wake ghost and produce an awakening. A linear fit from our definition of the arousal threshold (a drive with units of voltage) to an auditory decibel scale used in clinical experiments allows us to predict the arousal threshold vs. time since sleep onset, which exhibits good agreement with data, as seen in Fig. 3.8. This procedure is generalizable to other types of external stimuli, including pharmaceuticals (cf. Sect. 3.4.6), which can be represented similarly in terms of their relative drives to the MA and VLPO. The present approach allows arousal state responses to be interpreted in terms of the underlying physiological interactions that produce them, a feature that is lacking in phenomenological treatments.

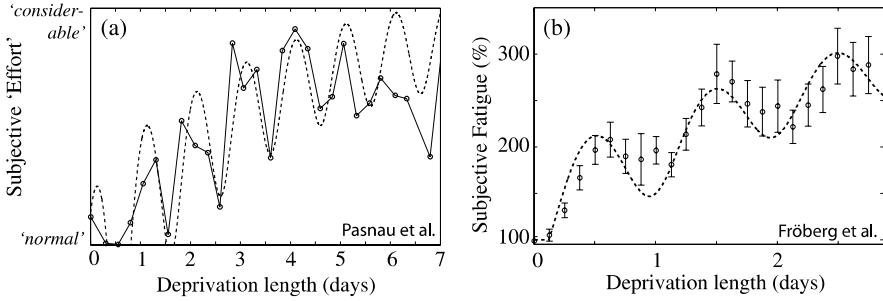

Fig. 3.9 Model fits to clinical subjective fatigue data (Fulcher et al. 2010). Data are shown with circles and model fits with a *dashed line*. **(a)** Subjective ‘effort’ data from a seven-day sleep deprivation study reported by Pasnau et al. (1968). Simulated wake effort over the same period of sleep deprivation is rescaled by a proportionality factor to reproduce the observations. **(b)** Subjective fatigue from a study by Fröberg et al. (1975) scaled to the model’s wake-effort drive

3.4.5 Wake Effort and Fatigue

The wake ghost is a near-stable waking state at high D , where only sleep is stable. Ordinarily, as D increases past its wake-sleep bifurcation value ($D \approx 2.5$ mV), the system drops to sleep. However, with the application of an external drive, it is possible to keep the system in the wake ghost to maintain wakefulness during normal sleep periods. Since this drive corresponds to an additional input required to prevent the system from falling asleep, we term it ‘wake effort’ and model it as a drive to the MA, as motivated by physiological findings that suggest a possible orexinergic pathway (Yoshida et al. 2001). The effort required to remain awake is zero on the wake branch, and increases with D in the wake ghost, consistent with the intuitive increase in difficulty to remain awake at high sleep drives. Simulating sleep deprivation in this way produces a wake-effort time series that can be compared directly to experiment. We have confirmed our hypothesized correlation between wake effort and subjective fatigue levels with multiple comparisons to data (Fulcher et al. 2010), as shown in Fig. 3.9.

Performance levels are also expected to correlate with our wake-effort drive to the MA, although the relationship is both nonlinear and task-dependent. For example, since orexinergic neurons in the lateral hypothalamic area receive motivational inputs from the limbic system (Scammell 2003), this additional motivation-dependent drive might decrease that required from other sources (e.g., cortical) and hence improve performance (Fulcher et al. 2010). Future work will investigate the relationship between performance and wake effort during sleep deprivation, including modeling catastrophic lapses, in which the subject fails to provide the required wake effort and arousal drops with a fall in V_m toward the sleep branch. The implementation of the wake-effort drive to simulating sleep deprivation is a step toward a quantitative, physiologically based treatment of performance during sleep deprivation, which is of great importance for the safety of many shift workers.

3.4.6 Caffeine

Caffeine is a competitive antagonist of adenosine, since it competes for adenosine receptor sites in the brain, reducing the amount of adenosine bound, and partially masking its effects. It also reduces inhibition of basal forebrain ACh by adenosine, increasing the firing rate of ACh nuclei (Carter et al. 1995), and the value of A in (28). These effects are modeled by the replacements:

$$v_{vh} \rightarrow v_{vh}[1 - \zeta_H Z_C(t)], \quad (3.32)$$

$$A \rightarrow A + \zeta_A Z_C(t), \quad (3.33)$$

where Z_C is the concentration of caffeine in mg/kg and ζ_A and ζ_H are constants determined from comparison with experiments on caffeine's disruption of sleep (Puckridge et al. 2010).

We model the pharmacokinetics of caffeine using a one-compartment approximation that treats brain and body as a single well-mixed container (Csajka et al. 2004; Gibaldi and Perrier 1975). Caffeine is absorbed into the body at a rate proportional to the dosage, and is subsequently eliminated at a rate proportional its concentration, giving

$$Z_C(t) = \gamma [e^{-k_e(t-t_0)} - e^{-k_a(t-t_0)}], \quad \text{for } t \geq t_0, \quad (3.34)$$

where $k_a \approx 10^{-3} \text{ s}^{-1}$ and $k_e \approx 4.5 \times 10^{-5} \text{ s}^{-1}$ are rate constants (which may depend on individual caffeine tolerance), respectively, and γ and t_0 are the level and time of the dose, respectively.

Figure 3.10 shows model output for a subject with a habitual bed time of 23:00 who takes 200 mg of caffeine at 22:00. Caffeine delays sleep onset and shortens sleep duration because: (i) D decreases temporarily, shifting the system away from sleep; and (ii) the increase in A moves the bifurcation points to higher D , allowing wake to be stable at larger D . The delay in sleep onset is associated with a smaller delay in waking, because C grows during early morning, prompting the subject to wake. The subject thus has shorter sleep and more accumulated adenosine than without caffeine. The amount of sleep loss S_l and delay to sleep S_d , are found to follow

$$S_l \approx \gamma N_l e^{-k_e T}, \quad (3.35)$$

$$S_d \approx \gamma N_d e^{-k_e T}, \quad (3.36)$$

where T is the time between caffeine intake and normal sleep time, and the proportionality constants are $N_l \approx 5 \text{ min (mg/kg)}^{-1}$ and $N_d \approx 9 \text{ min (mg/kg)}^{-1}$, for subjects of low caffeine sensitivity.

The model successfully matches the clinical data of Peneta et al. (1993), who followed the sleepiness of subjects over a 60 h period of total sleep deprivation. They compared the effectiveness of 600 mg of caffeine against a placebo on the 49th hour of the study. The sleepiness of the subjects was assessed via the Stanford Sleepiness Scale (Hoddes et al. 1973) in which the subject reported their level of alertness S with $S = 1$ corresponding to “feeling active and wide awake” to $S = 7$

Fig. 3.10 Examples of the model dynamics with and without a caffeine dose of 200 mg taken at 22:00 (true clock time resets to zero at 24:00 on the *time axis*). The caffeine case is shown *solid*, while a baseline case (no caffeine taken) is shown *dashed*. In (b), the effective homeostatic drive felt by the subject who takes caffeine is shown *gray*

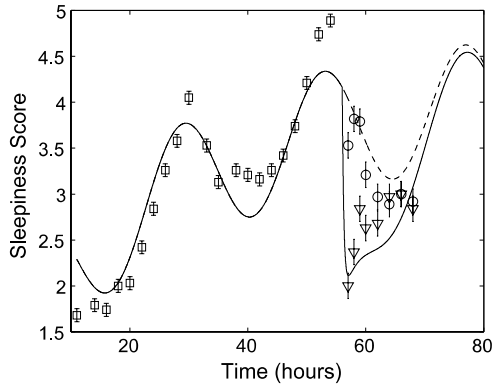
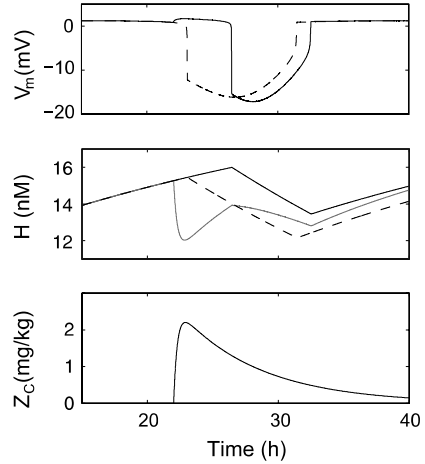

Fig. 3.11 Model output vs. clinical fatigue data from a sleep deprivation experiment (Peneta et al. 1993). Subjects took either caffeine or placebo at 54 h (corresponding to 49 h of total sleep deprivation). Experimental values are shown with *squares*, *triangles*, and *circles*, for S before either dose, after a caffeine dose, and after a placebo dose, respectively, using the linear fit (3.37). Simulated values are shown *solid* and *dashed*, for subjects with low caffeine sensitivity who took or did not take caffeine, respectively

denoting “losing the struggle to remain awake”. The score S is found to be linearly related to D , with

$$S = c_1 D + c_2, \quad (3.37)$$

where $c_1 \approx 0.23 \text{ (mV)}^{-1}$ and $c_2 \approx 2.33$ (Puckeridge et al. 2010). Comparison with experimental data in Fig. 3.11 shows that both exhibit a steady increase in S with superposed circadian oscillations. They concur that caffeine reduces S by approximately 2.5 and that its effects are lost after about 15 h (≈ 3 decay times).

3.5 Summary and Discussion

Physiologically based neural-field theories of the brain are able to incorporate essential physiology and anatomy across the many scales necessary to a wide range of neural phenomena. They can achieve this for physiologically realistic parameters, and yield numerous predictions that accord with observations using a variety of experimental methods in both the linear and nonlinear regimes. Moreover, they do this in a way that unifies what have hitherto been disparate subfields and experimental modalities in a single framework, and which permits parameter determination via fits of model predictions to experimental data. In addition to these specific results, major qualitative conclusions that are reached using such models include the necessity of incorporating the thalamus to understand EEG phenomena at frequencies below about 20 Hz, and the need to include the ascending arousal system to understand sleep–wake dynamics.

The models reviewed here provide a framework for additional applications to phenomena such as chronic sleep deprivation and sleep in other species. It also lays the foundation for further generalization and integration of additional physiology. In particular, inclusion and calibration of more realistic circadian inputs via the suprachiasmatic nucleus in order to treat shiftwork, jetlag, and chronotypes (morning and evening types), and inclusion of orexinergic nuclei. Incorporation of the diffusely projecting output from ACh nuclei to cortex and thalamus will enable key corticothalamic parameters that determine EEGs to be set by the sleep–wake system, although other feedforwards and feedbacks (see Fig. 3.1) will also need to be incorporated to obtain a detailed model of such interactions.

Acknowledgements The Australian Research Council, The National Health and Medical Research Council, and the National Space Biomedical Research Institute through NASA NCC 9-58 supported this work.

References

- Achermann P, Borbély AA (2003) Mathematical models of sleep regulation. *Front Biosci* 8:s683–s693
- Berridge CW, Waterhouse BD (2003) The locus coeruleus-noradrenergic system: modulation of behavioral state and state-dependent cognitive processes. *Brain Res Rev* 42:33–84
- Binney JJ, Dowrick NJ, Fisher AJ, Newman MEJ (1992) *The theory of critical phenomena*. Clarendon, Oxford
- Bonnet MH, Webb WB, Barnard G (1979) Effect of flurazepam, pentobarbital, and caffeine on arousal threshold. *Sleep* 1:271–279
- Braitenberg V, Schüz A (1991) *Anatomy of the cortex: statistics and geometry*. Springer, Berlin
- Breakspear M, Roberts JA, Terry JR, Rodrigues S, Mahant N, Robinson PA (2006) A unifying explanation of primary generalized seizures through nonlinear brain modeling and bifurcation analysis. *Cereb Cortex* 16:1296–1313
- Carter A, O'Connor W, Carter M, Ungerstedt U (1995) Caffeine enhances acetylcholine release in the hippocampus in vivo by a selective interaction with adenosine A1 receptors. *J Pharmacol Exp Ther* 273:637–642

- Clearwater J, Rennie C, Robinson P (2007) Mean field model of acetylcholine mediated dynamics in the cerebral cortex. *Biol Cybern* 97:449–460
- Csajka C, Haller C, Verotta D (2004) Mechanistic pharmacokinetic modeling of ephedrine, norephedrine, and caffeine in healthy subjects. *Br J Clin Pharmacol* 59:335–345
- Deco G, Jirsa VK, Robinson PA, Breakspear M, Friston K (2008) The dynamic brain: From spiking neurons to neural masses and cortical fields. *PLoS Comput Biol* 4:e1000092
- Freeman WJ (1975) *Mass action in the nervous system*. Academic Press, New York
- Fröberg JE, Karisson C, Levi L, Lidberg L (1975) Circadian rhythms of catecholamine excretion, shooting range performance and self-ratings of fatigue during sleep deprivation. *Biol Psychol* 2:175–188
- Fulcher BD, Phillips AJK, Robinson PA (2008) Modeling the impact of impulsive stimuli on sleep–wake dynamics. *Phys Rev E* 78:051920
- Fulcher BD, Phillips AJK, Robinson PA (2010) Quantitative physiologically based modeling of subjective fatigue during sleep deprivation. *J Theor Biol* 264(2):407–419
- Gibaldi M, Perrier D (1975) *Pharmacokinetics*, vol 1. Dekker, New York
- Henderson JA, Phillips AJK, Robinson PA (2006) Multielectrode electroencephalogram power spectra: Theory and application to approximate correction of volume conduction effects. *Phys Rev E* 73:051918
- Hoddes E, Zarcone Smythe H V, Phillips R, Dement W (1973) Quantification of sleepiness: A new approach. *Psychophysiology* 10:431–436
- Horton JC, Adams DL (2005) The cortical column: A structure without a function. *Philos Trans R Soc Lond B, Biol Sci* 360:837–862
- Kandel ER, Schwartz JH, Jessell TM (2000) *Principles of neural science*, 4th edn. McGraw-Hill, New York
- Jirsa VK, Haken H (1996) Field theory of electromagnetic brain activity. *Phys Rev Lett* 77:960–963
- Lamond N, Jay S, Dorrian J, Ferguson S, Jones C, Dawson D (2007) The dynamics of neurobehavioral recovery following sleep loss. *J Sleep Res* 16:33–41
- Lammers WJ, Badia P, Hughes R, Harsh J (1991) Temperature time-of-night of testing, and responsiveness to stimuli presented while sleeping. *Psychophysiology* 28:463–467
- Lopes da Silva FH, Hoeks A, Smits H, Zetterberg LH (1974) Model of brain rhythmic activity. The alpha-rhythm of the thalamus. *Kybernetik* 15:27–37
- Nunez PL (1974) The brain wave equation: A model for the EEG. *Math Biosci* 21:279–297
- Nunez PL (1995) *Neocortical dynamics and human EEG rhythms*. Oxford University Press, New York
- Nunez PL, Srinivasan R (2006) *Electric fields of the brain: the neurophysics of EEG*, 2nd edn. Oxford University Press, New York
- O'Connor SC, Robinson PA (2003) Wave-number spectrum of electrocorticographic signals. *Phys Rev E* 67:051912
- O'Connor SC, Robinson PA, Chiang AKI (2002) Wave-number spectrum of electroencephalographic signals. *Phys Rev E* 66:061905
- Pace-Schott EF, Hobson JA (2002) The neurobiology of sleep: Genetics, cellular physiology and subcortical networks. *Nat Rev, Neurosci* 3:591–605
- Pasnau RO, Naitoh P, Stier S, Kollar EJ (1968) The psychological effects of 205 hours of sleep deprivation. *Arch Gen Psychiatry* 18:496–505
- Peneta D, McCann U, Thorne D, Kamimori G, Galinski C, Sing H, Thomas M, Belenky G (1993) Caffeine reversal of sleep deprivation effects on alertness and mood. *Psychopharmacology* 112:359–365
- Phillips AJK, Robinson PA (2007) A quantitative model of sleep–wake dynamics based on the physiology of the brainstem ascending arousal system. *J Biol Rhythms* 22(2):167–179
- Phillips AJK, Robinson PA (2008) Sleep deprivation in a quantitative physiologically-based model of the ascending arousal system. *J Theor Biol* 255(4):413–423
- Puckeridge M, Fulcher BD, Phillips AJK, Robinson PA (2010) Incorporation of caffeine into a quantitative model of fatigue and sleep. *J Theor Biol* 273(1):44–54

- Rennie CJ, Robinson PA, Wright JJ (1999) Effects of local feedback on dispersion of electrical waves in the cerebral cortex. *Phys Rev E* 59(3):3320–3329
- Rennie CJ, PA Robinson, Wright JJ (2002) Unified neurophysical model of EEG spectra and evoked potentials. *Biol Cybern* 86:457–471
- Robinson PA (2003a) Neurophysical theory of coherence and correlations of electroencephalographic and electrocorticographic signals. *J Theor Biol* 222:163–175
- Robinson PA (2003b) Interpretation of scaling properties of electroencephalographic fluctuations via spectral analysis and underlying physiology. *Phys Rev E* 67:032902
- Robinson PA (2005) Propagator theory of brain dynamics. *Phys Rev E* 72:011904
- Robinson PA (2006) Patchy propagators, brain dynamics, and the generation of spatially structured gamma oscillations. *Phys Rev E* 73:041904
- Robinson PA (2011, submitted) Neural field theory of synaptic plasticity. *J Theor Biol*
- Robinson PA, Rennie CJ, Wright JJ (1997) Propagation and stability of waves of electrical activity in the cerebral cortex. *Phys Rev E* 56(1):826–840
- Robinson PA, Rennie CJ, Wright JJ, Bourke P (1998) Steady states and global dynamics of electrical activity in the cerebral cortex. *Phys Rev E* 58(3):3557–3571
- Robinson PA, Loxley PN, O'Connor SC, Rennie CJ (2001a) Modal analysis of corticothalamic dynamics, electroencephalographic spectra, and evoked potentials. *Phys Rev E* 63(4):041909
- Robinson PA, Rennie CJ, Wright JJ, Bahramali H, Gordon E, Rowe DL (2001b) Prediction of electroencephalographic spectra from neurophysiology. *Phys Rev E* 63(2):021903
- Robinson PA, Rennie CJ, Rowe DL (2002) Dynamics of large-scale brain activity in normal arousal states and epileptic seizures. *Phys Rev E* 65(4):041924
- Robinson PA, Rennie CJ, Rowe DL, O'Connor SC, Wright JJ, Gordon E, Whitehouse RW (2003a) Neurophysical modeling of brain dynamics. *Neuropsychopharmacology* 28:s74–s79
- Robinson PA, Whitehouse RW, Rennie CJ (2003b) Nonuniform corticothalamic continuum model of electroencephalographic spectra with application to split-alpha peaks. *Phys Rev E* 68:021922
- Robinson PA, Rennie CJ, Rowe DL, O'Connor SC (2004) Estimation of multiscale neurophysiological parameters by electroencephalographic means. *Hum Brain Mapp* 23:53–72
- Robinson PA, Wu H, Kim JW (2008) Neural rate equations for bursting dynamics derived from conductance-based spike equations. *J Theor Biol* 250:663–672
- Robinson PA, Rennie CJ, Phillips AJK, Kim JW, Roberts JA (2010) Phase transitions in physiologically based multiscale mean-field brain models. In: Steyn-Ross DA, Steyn-Ross M (eds) *Modeling phase transitions in the brain*. Springer, New York, pp 179–201
- Rowe DL, Robinson PA, Rennie CJ (2004) Estimation of neurophysiological parameters from the waking EEG using a biophysical model of brain dynamics. *J Theor Biol* 231:413–433
- Saper CB, Chou TC, Scammell TE (2001) The sleep switch: hypothalamic control of sleep and wakefulness. *Trends Neurosci* 24:726–731
- Scammell TE (2003) The neurobiology, diagnosis, and treatment of narcolepsy. *Ann Neurol* 53:154–166
- Sherman SM, Guillery RW (2001) *Exploring the thalamus*. Academic Press, San Diego
- Stepanski EJ (2002) The effect of sleep fragmentation on daytime function. *Sleep* 25:268–276
- Steriade M, Gloor P, Llinás RR, Lopes da Silva FH, Mesulam MM (1990) Basic mechanisms of cerebral rhythmic activities. *Electroencephalogr Clin Neurophysiol* 76:481–508
- Steriade M, Jones EG, McCormick DA (eds) (1997) *Thalamus*, 1–2 vols. Amsterdam, Elsevier
- Steyn-Ross ML, Steyn-Ross DA, Sleight JW, Liley DTJ (1999) Theoretical electroencephalogram stationary spectrum for a white-noise-driven cortex: Evidence for a general anesthetic-induced phase transition. *Phys Rev E* 60(6):7299–7311
- Steyn-Ross DA, Steyn-Ross ML, Seigh JW, Wilson MT, Gillies IP, Wright JJ (2005) The sleep cycle modelled as a cortical phase transition. *J Biol Phys* 31:547–569
- Steyn-Ross DA, Steyn-Ross ML, Wilson MT, Sleight JW (2006) White-noise susceptibility and critical slowing in neurons near spiking threshold. *Phys Rev E* 74:051920
- Strogatz SH (1994) *Nonlinear dynamics and chaos: with applications to physics, biology, chemistry, and engineering*. Addison-Wesley, Reading

- van Albada SJ, Robinson PA (2009) Mean-field modeling of the basal ganglia-thalamocortical system. I. Firing rates in healthy and parkinsonian states. *J Theor Biol* 257:642–663
- van Albada SJ, Kerr CC, Chiang AKI, Rennie CJ, Robinson PA (2009a) Neurophysiological changes with age probed by inverse modeling of EEG spectra. *Clin Neurophysiol* 121:21–38
- van Albada SJ, Gray RT, Drysdale PM, Robinson PA (2009b) Mean-field modeling of the basal ganglia-thalamocortical system II: Dynamics of parkinsonian oscillations. *J Theor Biol* 257:664–688
- Wilson HR (1999) *Spikes, decisions, and actions: the dynamical foundations of neurosciences*. Oxford University Press, Oxford
- Wilson HR, Cowan JD (1973) A mathematical theory of the functional dynamics of cortical and thalamic nervous tissue. *Kybernetik* 13:55–80
- Wright JJ, Liley DTJ (1996) Dynamics of the brain at global and microscopic scales: Neural networks and the EEG. *Behav Brain Sci* 19:285–309
- Yoshida Y, Fujiki N, Nakajima T, Ripley B, Matsumura H, Yoneda H, Mignot E, Nishino S (2001) Fluctuation of extracellular hypocretin-1 (orexin A) levels in the rat in relation to the light–dark cycle and sleep–wake activities. *Eur J Neurosci* 14:1075–1081

Chapter 4

The Fine Structure of Slow-Wave Sleep Oscillations: from Single Neurons to Large Networks

A. Destexhe and D. Contreras

4.1 Introduction

The discovery that the electrical activity of the brain oscillates during sleep is almost as old as the discovery of the electroencephalogram (EEG). The first human EEG recordings already reported a propensity to show oscillations, of which type, frequency and amplitude highly depend on behavioral state (Berger 1929; see Fig. 4.1). In an alert, awake subject, the EEG is dominated by low-amplitude fast activity (“desynchronized EEG”) with high-frequency oscillations (beta, gamma), whereas during slow-wave sleep, the EEG shifts to large-amplitude, slow oscillations. The early stage of slow-wave sleep is associated with the appearance of spindle waves, which occur at a frequency of 7 to 14 Hz. As sleep deepens, EEG waves with slower frequencies (0.1 to 4 Hz), including delta waves and slow oscillations, appear and progressively dominate the EEG. During paradoxical sleep, also called rapid-eye movement (REM) sleep, EEG activities are desynchronized and resemble those of wakefulness. Finally, some pathological states also display clear-cut oscillations, such as the “spike-and-wave” patterns (~ 3 Hz) characteristic of many types of generalized epileptic seizures.

The cellular bases of slow-wave sleep oscillations have been investigated since the first extracellular and intracellular recordings in mammals. The major brain regions which have been identified are the thalamus and cerebral cortex, which are intimately linked by means of reciprocal projections. The activities of thalamic and cortical neurons during sleep have been largely documented by electrophysiological studies. The cellular mechanisms underlying these oscillations depend on many

A. Destexhe (✉)

Unité de Neurosciences, Information et Complexité (UNIC), CNRS, 1 Avenue de la Terrasse (Bat. 33), 91190 Gif-sur-Yvette, France
e-mail: Destexhe@unic.cnrs-gif.fr

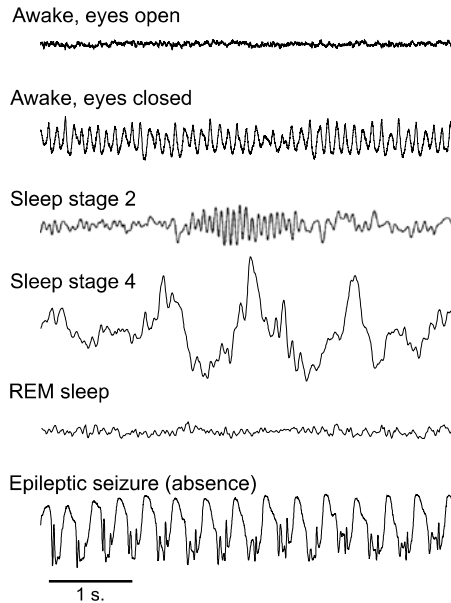

Fig. 4.1 Electroencephalographic recordings during different brain states in humans. 5 seconds of EEG activity are shown for different brain states, from top to bottom: Awake with eyes open, in which the EEG is dominated by low-amplitude fast activities (> 15 Hz, beta and gamma frequency range); Awake with eyes closed, in which alpha rhythm (10–12 Hz) appears; Sleep stage 2, characterized by sleep spindles (7–14 Hz); Sleep Stage 4, characterized by delta and slow-wave activity (0.1–4 Hz). During REM sleep, the activity is similar to wakefulness. During absence epileptic seizures (*bottom*), the EEG displays spike-and-wave patterns at ~ 3 Hz. Modified from Destexhe (1992)

factors, such as the connectivity and intrinsic properties of the different types of thalamic and cortical neurons. Of great help to understand these cellular mechanisms, is the use of computational models, which are based on experimental data, and if possible, generate predictions to test them. This type of interaction between experimental results and modeling efforts has been quite successful in the (still ongoing) exploration of the mechanisms of sleep oscillations, which this chapter attempts to summarize.

4.2 Relation Between EEG and Single Cells During Sleep and Waking Oscillatory Activity in Cats

In cats, the electroencephalogram (EEG) exhibits a rich variety of oscillatory patterns during wake and sleep. Here we review the spatiotemporal distribution of two oscillations characteristic of slow-wave sleep as well as fast oscillations that characterize wake and rapid-eye movement (REM) sleep episodes. We also relate these oscillations to the firing of extracellularly recorded cortical neurons at multiple sites

and to the V_m and firing of single cells recorded intracellularly, thus setting the stage for exploring the possible physiological roles of these oscillations. This spatiotemporal characterization can be found in more detail in a previous publication (Destexhe et al. 1999a).

Multisite local field potentials (LFPs) were recorded using a set of 8 equidistant bipolar electrodes in the cerebral cortex (suprasylvian gyrus) of un-anesthetized cats. Wake/sleep states were identified using the following criteria: Wake: low-amplitude fast activity in LFPs, high electrooculogram (EOG) and high electromyogram (EMG) activity; Slow-wave sleep: LFPs dominated by high-amplitude slow-waves, low EOG activity and EMG activity present; REM sleep: low-amplitude fast LFP activity, high EOG activity and abolition of EMG activity. During waking and attentive behavior, LFPs were characterized by low-amplitude fast (15–75 Hz) activity (Fig. 4.2A, Awake). During slow-wave sleep, LFPs were dominated by high-amplitude slow-wave complexes occurring at a frequency of <1 Hz (Fig. 4.2B, Slow-wave sleep). Slow-wave complexes of higher frequency (1–4 Hz) and spindle waves (7–14 Hz) were also present in slow-wave sleep. During periods of REM sleep, cortical activity was similar to that observed during awake states (Fig. 4.2C, REM sleep).

The decay of correlations as a function of distance revealed marked differences in large-scale coherence between awake/REM and slow-wave sleep (Fig. 4.2, right panels). Slow-wave complexes during slow-wave sleep episodes displayed high spatiotemporal coherence, in contrast with the steeper decline of the correlations with distance during wakefulness and REM sleep. The same patterns of the spatial correlations were observed in different animals and during different wake/sleep episodes in the same animals (Fig. 4.2) (see details in Destexhe et al. 1999a, and references therein).

Spindle oscillations were also present in the early phases of slow-wave sleep, and were recorded not only in natural sleep, but also under different types of anesthesia (Fig. 4.3; Contreras et al. 1997). Under ketamine-xylazine anesthesia (10–15 mg/kg; 2–3 mg/kg, i.m.), spindles are preceded by a depth-positive cortical EEG wave that ends with a sharp negative wave followed by a waning spindle sequence, usually at the upper frequency limit of spindling (13–14 Hz) (Fig. 4.3, Ketamine). Under barbiturate anesthesia (25–35 mg/kg), spindling is waxing and waning, and its frequency is lower with increasing barbiturate doses (Fig. 4.3 Barbiturate). During natural slow-wave sleep, two types of spindle patterns were observed, one with the characteristic waxing-and-waning pattern (Fig. 4.3 Natural sleep, right panel), while the other was similar to K-complexes in which spindles were preceded by an EEG biphasic complex (depth-positive, depth-negative) and lacked the initial waxing feature (Fig. 4.3, Natural sleep, left panel).

The relation between extracellularly recorded units and the corresponding LFP activities (from the same set of electrodes) during wakefulness and natural sleep is shown in Fig. 4.4. When the animal was awake, the desynchronized EEG was associated with very irregular firing activity in the units (Fig. 4.4A,B, Wake). There was no apparent relation between units and LFP by visual inspection, although a statistical analysis revealed that the depth-negative deflections were on average related to

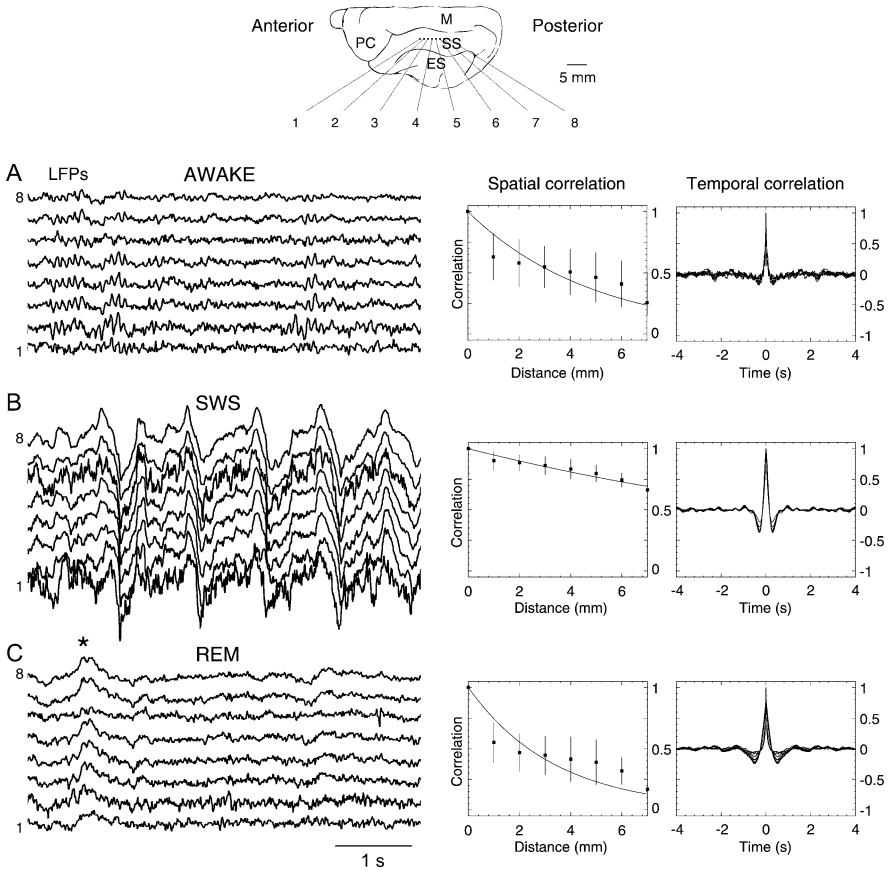

Fig. 4.2 Multisite local field potentials in cat cerebral cortex during natural wake and sleep states. Eight bipolar electrodes (inter-electrode distance of 1 mm) were inserted into the depth (1 mm) of areas 5–7 of cat neocortex (suprasylvian gyrus, area 5–7; see *top scheme* for arrangement of electrodes). Local field potentials (LFPs) are shown (*left panels*) together with a representation of the correlations as a function of distance (Spatial correlations; *middle panels*) and time (Temporal correlations; *right panels*). **A.** When the animal was awake, LFPs were characterized by low-amplitude fast activities in the beta/gamma frequency range (15–75 Hz). Correlations decayed steeply with distance and time. **B.** During slow-wave sleep, the LFPs were dominated by large-amplitude slow-wave complexes recurring at a slow frequency (<1 Hz; up to 4 Hz). Correlations stayed high for large distances. **C.** During episodes of REM sleep, LFPs and correlations had similar characteristics as during wake periods (* indicates a PGO wave). Modified from Destexhe et al. (1999a)

an increase of firing activity in the units (Fig. 4.4C, Wake; see details in Destexhe et al. 1999a). During slow-wave sleep, the ensemble activity was surprisingly similar to wakefulness (Fig. 4.4A, SWS), but at closer scrutiny (Fig. 4.4B), it appeared that synchronous “silences” in all the units appear systematically and simultaneously with the depth-positive part of the slow wave (Fig. 4.4A, SWS). This type of synchronized silence will be later referred as “Down-state”. This activity is also visible

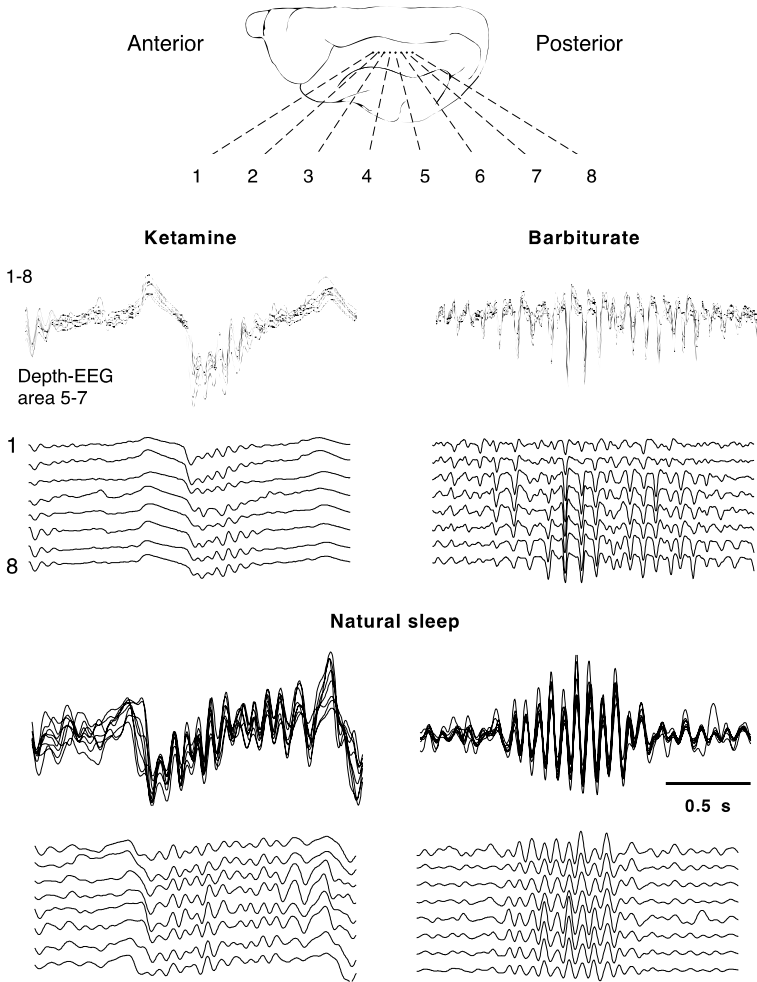

Fig. 4.3 Multisite local field potentials of spindle oscillations in cat cerebral cortex during sleep and anesthetized states. *Top panel:* scheme of the position of the recording electrodes in the suprasylvian gyrus. *Bottom panels:* examples of spindles recorded with the eight electrodes under anesthesia (ketamine-xylazine or barbiturate) are compared to spindling recorded in un-anesthetized, naturally sleeping animals. In each panel, the *top trace* is a superposition (1–8) of the eight traces displayed below. Two types of spindles are shown for natural sleep, a spindle oscillation following a K-complex (*bottom left*) and a waxing-and-waning spindle oscillation (*bottom right*). Modified from Contreras et al. (1997)

when computing the statistical relation between units and slow waves (Fig. 4.4C, SWS).

An analysis of spatial coherence was not done for spindle oscillations in cortex, but LFP and intracellular activity were recorded simultaneously in many studies demonstrating the broad synchronization of spindle oscillations. In particular, one

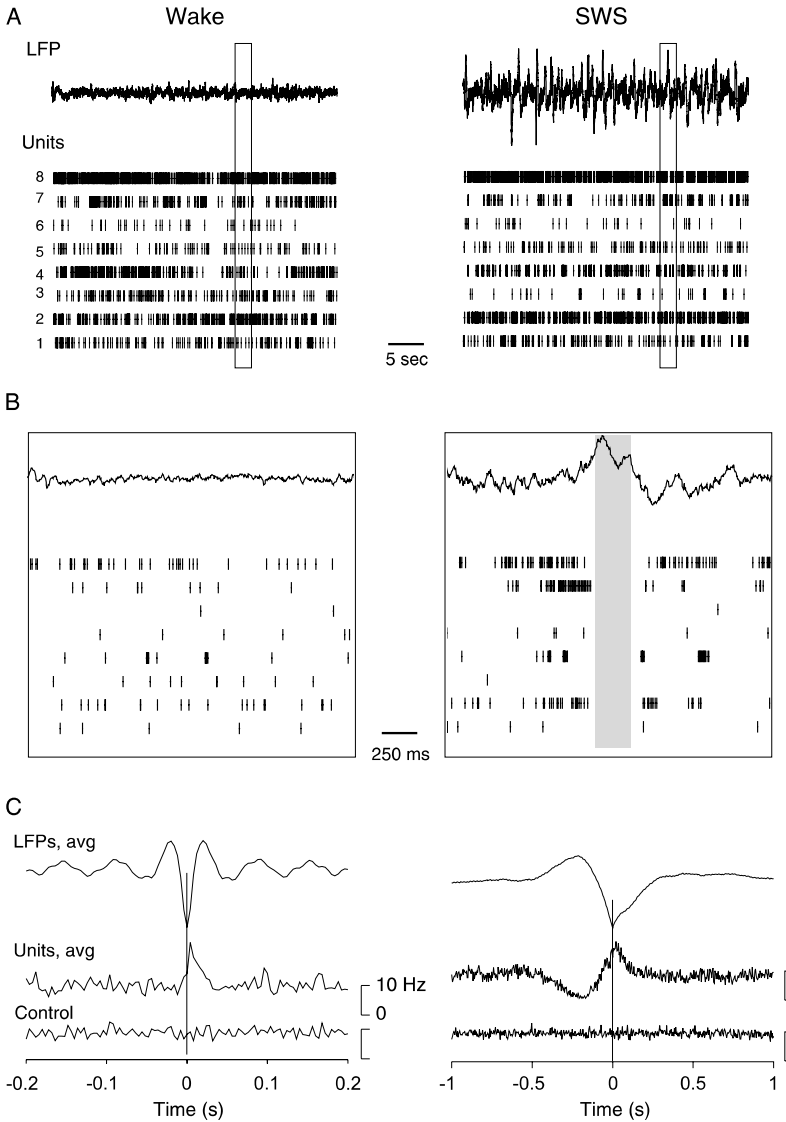

Fig. 4.4 Distributed firing activity in relation to LFPs during wake and sleep states. **A.** Irregular firing activity of 8 multi-units shown at the same time as the LFP recorded in electrode 1 (same setting as in Fig. 4.13). During wakefulness, the activity is sustained and irregular (see magnification below). During slow-wave sleep (SWS), the activity is similar to wakefulness, except that synchronized “silences” of firing activity occur in all cells simultaneously, and in relation to the slow waves. **B.** Same activity as in **A** at 20 times higher temporal resolution. The *gray box* indicates the synchronized silence (Down-state) simultaneous in all cells, and occurring in parallel with slow waves. **C.** Wave-triggered averages of spiking activity. During wakefulness, the LFP negative peaks were correlated with an increased firing activity in the units. During SWS, the negative peak of the slow wave was correlated with a strong decrease of firing in the units (Down-state), followed by a rebound a sustained activity (Up-state). Modified from Destexhe et al. (1999a)

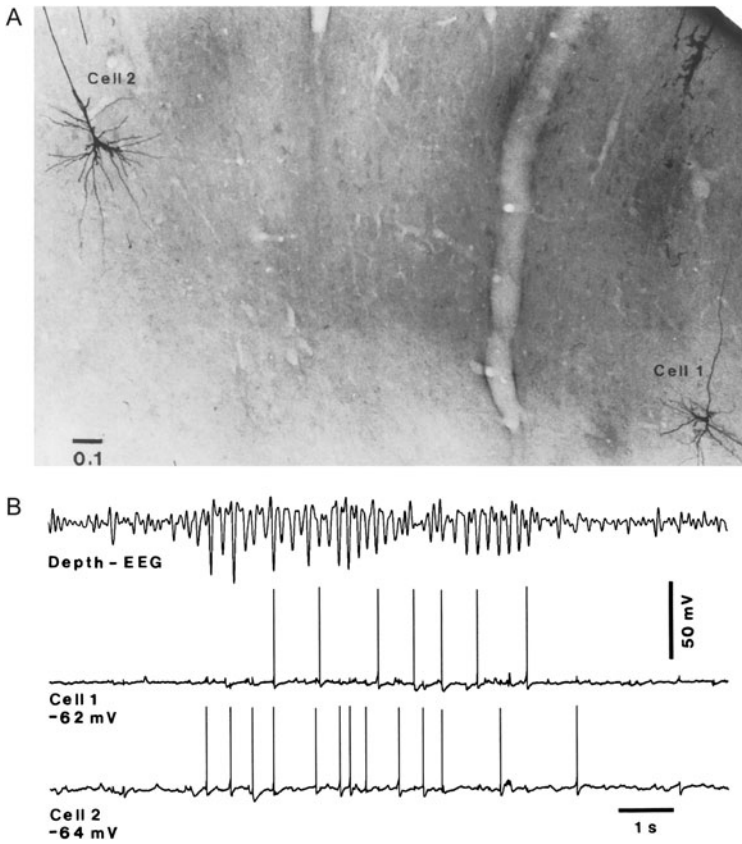

Fig. 4.5 Intracellular activity in cat parietal cortex during spindle waves. **A.** Two neurobiotin-stained pyramidal cells that were simultaneously recorded intracellularly in area 5–7 (distant by about 2.5 mm). **B.** Simultaneous activity of depth EEG (*top*) and the two cells during a spontaneous spindle oscillation (light barbiturate anesthesia). Modified from Contreras et al. (1997)

study (Contreras et al. 1997) obtained dual simultaneous intracellular recordings of morphologically identified pyramidal neurons (Fig. 4.5A) during spindles in barbiturate anesthesia. These intracellular recordings show synchronized, strong sub-threshold modulation of the membrane potential during spindles (Fig. 4.5B). The two recorded cells in this example fired sparsely during spindle oscillations. The relatively weak level of firing during spindles was commonly observed in a large database of intracellularly recorded neurons under different anesthetics and in natural slow-wave sleep states. It was attributed to an unusually strong intracortical inhibition, specifically recruited during spindle oscillations (Contreras et al. 1997).

Intracellular recordings were also obtained during natural slow-wave sleep (Steriade et al. 2001; Timofeev et al. 2001). As described above for extracellular activity (Fig. 4.4) the intracellular activity during wakefulness was very irregular, with little apparent relation between LFP and membrane potential recorded in the same

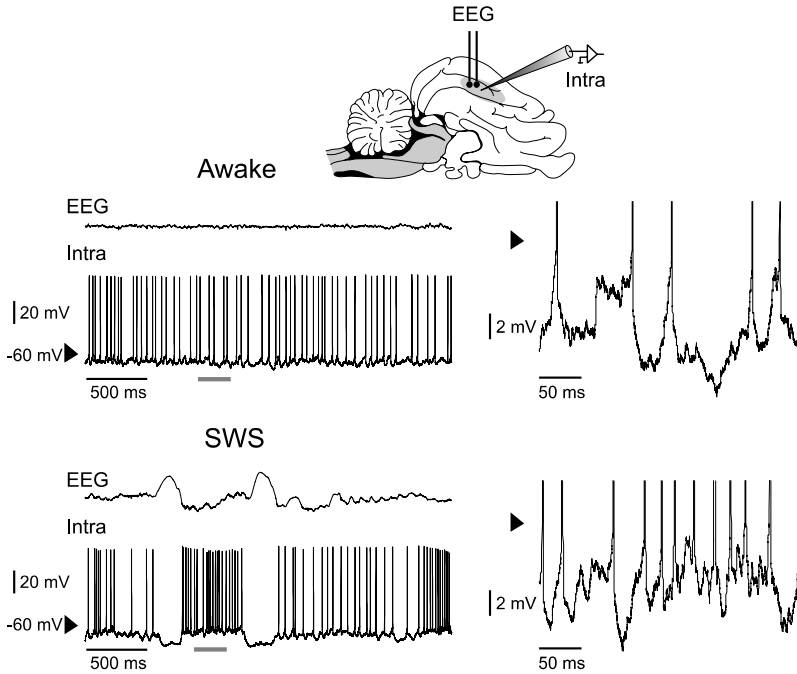

Fig. 4.6 Intracellular activity in cat parietal cortex during wakefulness and slow-wave sleep. LFP (called here EEG) and intracellular recording were obtained in area 5–7 of cat cortex (*scheme*). When the animal was awake (*top traces*), the EEG was desynchronized and the intracellular activity was sustained and irregular. During slow-wave sleep (SWS), the EEG displayed slow waves, which were correlated with “Down-states”: brief hyperpolarizations with interruption of firing. In between slow waves, the EEG was closer to desynchronized and the activity displayed “Up-states” with sustained and irregular firing similar to wakefulness. The *right panels* show a magnification of the V_m activity in each case. Modified from Steriade et al. (2001)

brain area (Fig. 4.6, Wake). During slow-wave sleep, the “silence” described above appeared as a hyperpolarization of the cell, simultaneous with the depth-positive part of the slow wave (Fig. 4.6, SWS). These define “Up” and “Down” states very clearly from the membrane potential activity. Such Up–Down-state dynamics was first described under anesthesia and constitutes the dominant oscillatory pattern under many anesthetic regimes (Steriade et al. 1993b; Contreras and Steriade 1995).

4.3 Genesis of Sleep Spindle Oscillations

As seen in the preceding section, sleep spindles consist of 7 to 14 Hz waxing-and-waning potentials, grouped in sequences lasting for 1 to 3 s and recurring every 3 to 10 s. Spindle oscillations constitute an interesting and well-constrained problem to investigate by computational models for several reasons. First, these oscillations are generated in the thalamus, which is a well-known structure anatomically, with

well-defined connectivity between the different cell types (see circuit in Fig. 4.11A). Second, spindles are remarkably well documented experimentally and have been extensively characterized both *in vivo* and *in vitro* (reviewed in Steriade et al. 1997; Steriade 2003; Destexhe and Sejnowski 2001, 2003). Third, this oscillation is generated by an interplay of complex cellular properties (schematized in Fig. 4.11B), such as burst firing (Jahnsen and Llinás 1984), and synaptic interactions via multiple types of postsynaptic receptors (see Fig. 4.11C). Computational models are needed to understand this complex interplay (reviewed in Destexhe and Sejnowski 2003).

The typical electrophysiological features of spindle oscillations in the thalamus are shown in Fig. 4.7. The two cell types involved, thalamocortical (TC) and thalamic reticular (RE) neurons oscillate synchronously and display burst discharges according to a mirror image: RE cells display bursts following excitatory synaptic potentials (EPSPs) while TC cells burst following inhibitory postsynaptic potentials (IPSPs). While RE cells tend to burst at every cycle of the oscillation, TC cells only produce bursts once every few cycles. These features are typical of spindles recorded in thalamic neurons in different mammals.

4.3.1 Thalamic Pacemakers for Spindles

Although it is clear that spindles are generated in the thalamus, several hypotheses for the genesis of oscillations by thalamic circuits have been proposed and tested by models (reviewed in Destexhe and Sejnowski 2001, 2003). These involve reciprocal synaptic interactions between TC neurons and local inhibitory interneurons, loops between TC and RE neurons, or loops within the RE nucleus. The involvement of the RE nucleus was firmly demonstrated in a series of experiments by Steriade's group (reviewed in Steriade et al. 1993d; Destexhe and Sejnowski 2001, 2003). In particular, the deafferented RE nucleus *in vivo* can exhibit spindle rhythmicity in extracellular recordings. In contrast, the RE nucleus does not display autonomous oscillations *in vitro*, but spindles have been observed in thalamic slices based on TC-RE interactions (see Steriade et al. 1997 a detailed account of these issues). These *in vitro* spindles display the same intracellular features as *in vivo*.

Computational models were designed to attempt clarifying these contrasting results, but here also, several hypothetical mechanisms were tested. First, models investigated whether the RE nucleus is capable of displaying oscillations consistent with experiments. Models found that RE neurons interacting through GABAergic synapses can generate spindle rhythmicity (Wang and Rinzal 1993; Destexhe et al. 1994c; Bazhenov et al. 1999; reviewed in Destexhe and Sejnowski 2001), but two different mechanisms were proposed. First, based on a Hodgkin-Huxley (1952) type model of the voltage-dependent Ca^{2+} current (T-type current) responsible for burst generation in RE cells, Wang and Rinzal (1993) proposed a "slow-inhibition hypothesis" to generate spindle oscillations. The interaction of RE cells endowed with the T-type current and interacting through inhibitory synapses

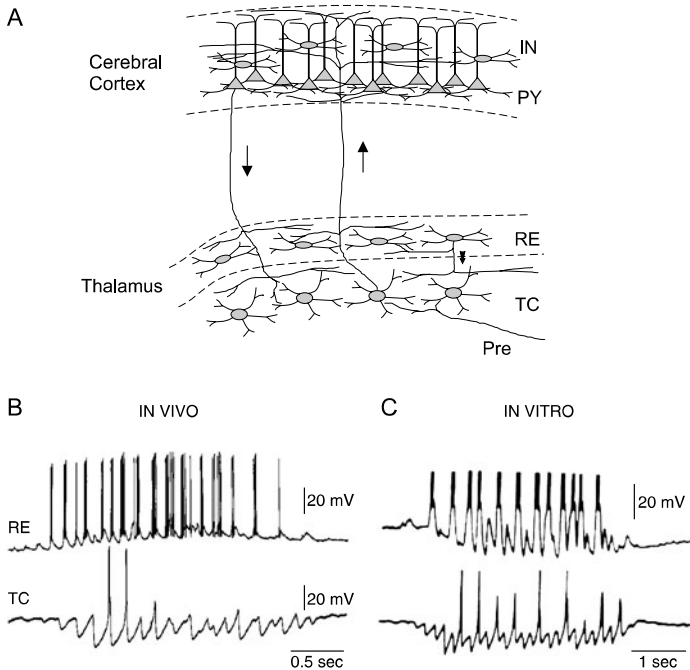

Fig. 4.7 Thalamocortical circuits and spindle oscillations. **A.** Thalamocortical network with four cell types and their connectivity: thalamocortical (TC) relay cells, thalamic reticular (RE) neuron, cortical pyramidal cells (PY) and interneurons (IN). TC cells receive prethalamic (Pre) afferent connections, which may be sensory afferents in the case of specific thalamic nuclei involved in vision, audition and somatosensory modalities. This information is relayed to the corresponding area of cerebral cortex through ascending thalamocortical fibers (*upward arrow*). These axons have collaterals that contact the RE nucleus on the way to the cerebral cortex, where they arborize in superficial layers I and II, layer IV and layer VI. Corticothalamic feedback is mediated primarily by a population of layer VI PY neurons that project to the thalamus. The corticothalamic fibers (*downward arrow*) also leave collaterals within the RE nucleus and dorsal thalamus. RE cells thus form an inhibitory network that surrounds the thalamus, receive a copy of nearly all thalamocortical and corticothalamic activity, and project inhibitory connections solely to neurons in the thalamic relay nuclei. **B.** Spindle oscillations in thalamic neurons *in vivo*, as seen through intracellular experiments in cats under barbiturate anesthesia. The activity of thalamocortical (TC) and thalamic reticular (RE) cells is shown during spindle waves (modified from Steriade and Deschênes 1984). **C.** *In vitro* intracellular experiments realized in ferret visual thalamic slices, showing the activity of the same type of thalamic neuron during spindle waves (modified from von Krosigk et al. 1993)

was found to be able to generate synchronized oscillations but only for slow-inhibitory interactions (Fig. 4.8A–B). They quantified the synchrony of RE oscillations as a function of the parameters of synaptic interactions and found a large region of parameter space supporting synchronized oscillations based on GABAergic interactions (Fig. 4.8C; Wang and Rinzel 1993).

Another hypothesis was later proposed based on fast GABAergic interactions (Destexhe et al. 1994c). This “fast-inhibition hypothesis” was proposed to palliate to the two main drawbacks of the slow-inhibition hypothesis, namely that the synchro-

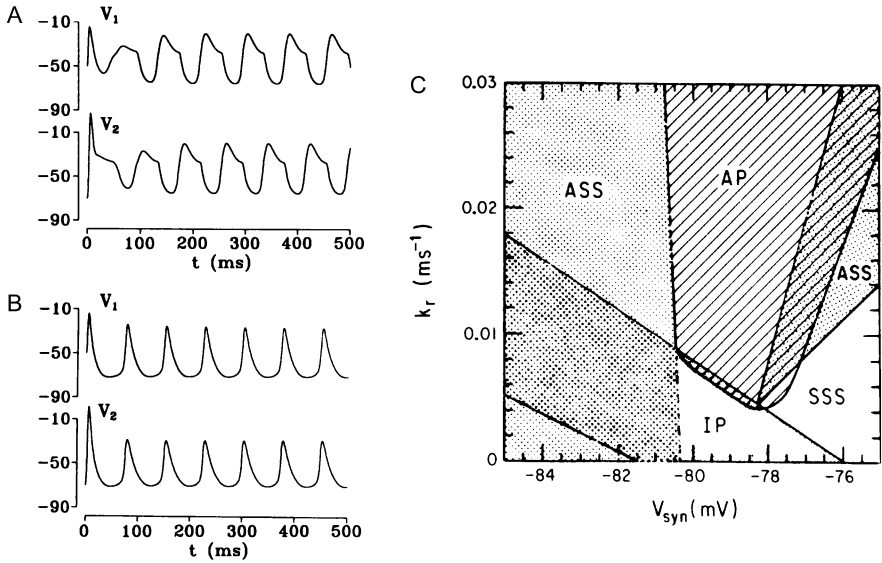

Fig. 4.8 The “slow-inhibition hypothesis” for generating synchronized oscillations with thalamic reticular neurons. **A.** Anti-phase oscillation with fast synaptic decay ($k_r = 0.5 \text{ ms}^{-1}$; V_1 and V_2 indicate two RE neurons interconnected with slow GABAergic synapses). **B.** In-phase oscillation with a fast-rising and slow-decaying synaptic conductance ($k_r = 0.005 \text{ ms}^{-1}$). **C.** State diagram indicating the behavior of the model as a function of the synaptic current decay (k_r) and reversal potential (V_{syn}). SSS, symmetric steady-state (blank); ASS asymmetric steady-state (stippled); IP, in-phase oscillation (shaded) as in **B**; AP, anti-phase oscillation (striped) as in **A**. The synchronous rhythmic behavior was possible only for sufficiently slow inhibition (small k_r) and negative V_{syn} . Modified from Wang and Rinzel (1993)

nized oscillations are too slow compared to experimental recordings in the isolated RE nucleus *in vivo* (Steriade et al. 1997), and that RE neurons were found experimentally to interact through fast GABA_A synapses (Huntsman et al. 1999). The problem was that according to the slow-inhibition model, fast decaying GABAergic synapses should not synchronize (Fig. 4.8C). However, by considering more extended connectivity (where each RE neuron connects densely to an extended neighborhood), it was found that synchronized fast oscillations can emerge with fast, GABA_A-mediated synapses (Fig. 4.9; Destexhe et al. 1994c). This conclusion was reached by using Hodgkin and Huxley (1952) type models for the T-type current, as well as for the Na⁺ and K⁺ to generate action potentials, while synaptic interactions were modeled by conductance-based kinetic models (Destexhe et al. 1994a, 1994b). This model displayed fast oscillation in the 10–15 Hz frequency range, and which showed “waxing-and-waning” patterns in the average activity (Fig. 4.9), as observed experimentally. Other models based on fast GABAergic synapses were proposed and also produced oscillations consistent with experiments (Bazhenov et al. 1999).

Thus, *in vivo* experiments and models indicate that the RE nucleus can display self-sustained oscillations in the spindle frequency range. However, *in vitro* exper-

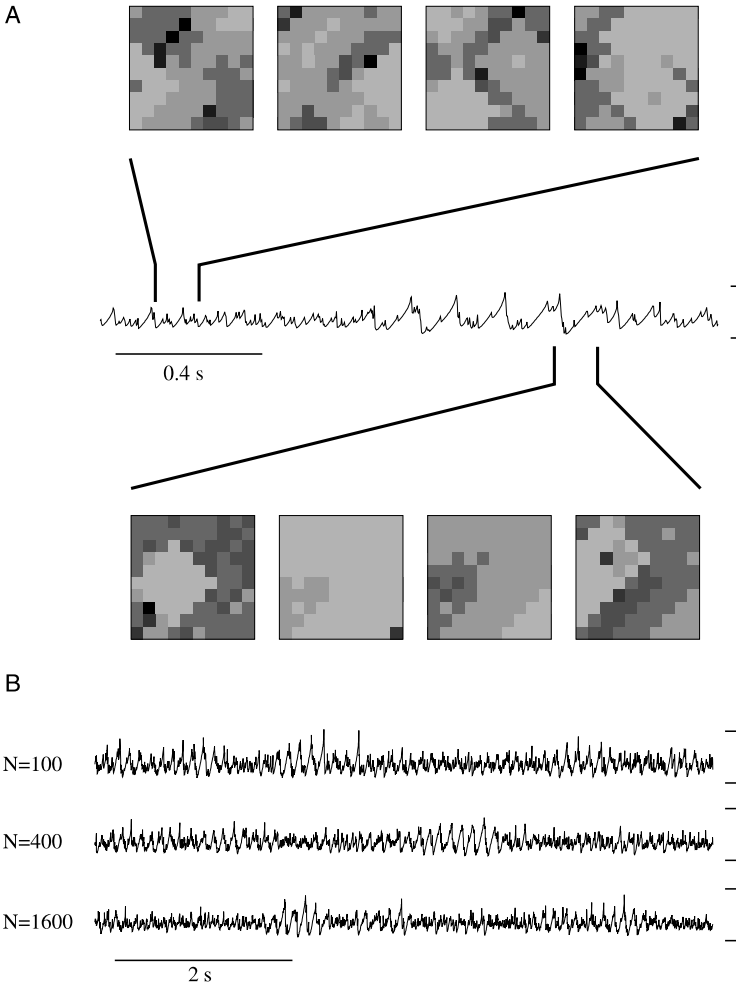

Fig. 4.9 “Fast-inhibition hypothesis” for spindle oscillations in the isolated RE nucleus. Snapshots of activity in a 100 neuron network during waxing-and-waning oscillations corresponding to the regions of the averaged membrane potential as indicated. The *top series* of snapshots was taken during the “desynchronized” phase and shows highly irregular spatiotemporal behavior. The *bottom series* of snapshots was taken during the “oscillatory” phase, when the network is more synchronized and coherent oscillations were found in the averaged activity. The time interval between frames was 40 ms. **B.** Averaged membrane potentials for networks with $N = 100$, $N = 400$ and $N = 1600$ neurons. For $N = 400$ and $N = 1600$, the local average membrane potential was obtained by averaging over a disk of 113 neurons in the center of the network. Vertical calibration bars for the average membrane potential traces are from -80 to -70 mV. Modified from Destexhe et al. (1994c)

iments on ferret thalamic slices demonstrated that spindle oscillations require the integrity of the interconnection between TC and RE cells, and disappear if a cut is realized in the slice between the two nuclei (Fig. 4.10A; von Krosigk et al. 1993).

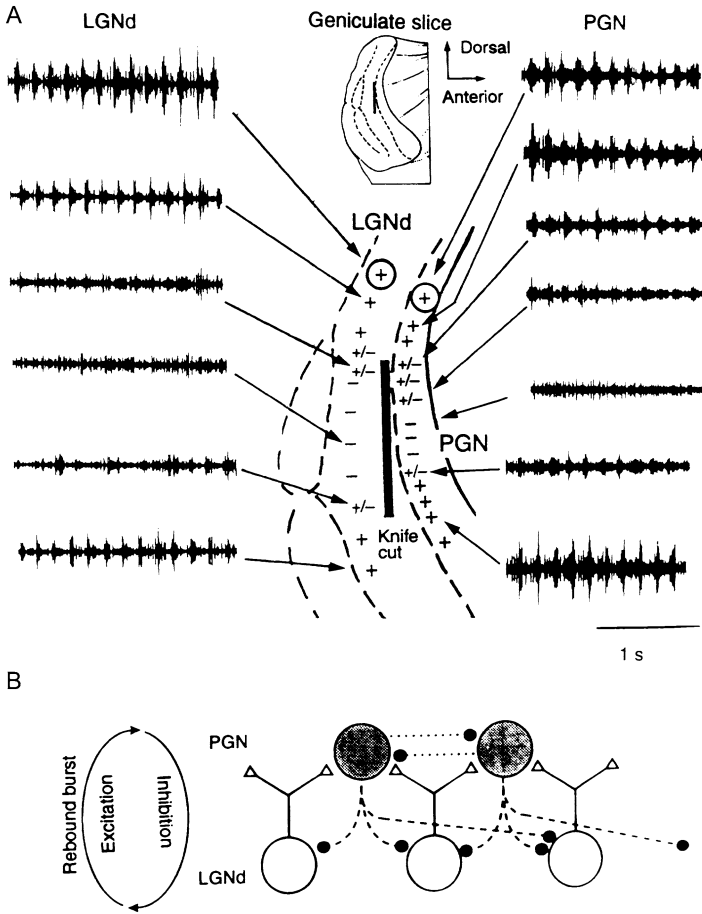

Fig. 4.10 *In vitro* spindle waves require functional interconnections between thalamic relay and reticular neurons. **A.** A small knife cut (1 mm) was performed between the LGNd and PGN in a thalamic slice from a ferret. Extracellular recordings at various locations of the LGNd and PGN revealed robust spindling in locations away from the cut (+), and the absence of spindling (-) in regions anterior and posterior to the center of the cut. **B.** Mechanism proposed based on *in vitro* observations: The oscillations are generated by a loop involving interconnected PGN and LGNd neurons, with AMPA-mediated excitation (LGNd → PGN) and GABA_A-mediated inhibition (PGN → LGNd; PGN → PGN). Modified from von Krosigk et al. (1993)

This suggests another mechanism for spindle generation, based on the reciprocal interaction between TC and RE cells (Fig. 4.10B).

These findings motivated the construction of another series of computational models that include TC and RE cells. Such models showed that spindle oscillations can indeed be obtained from TC-RE loops (Destexhe et al. 1996; Golomb et al. 1996). This TC-RE loop model is shown in Fig. 4.11. Neurons were modeled using Hodgkin and Huxley (1952) type representations of Na⁺, K⁺ and Ca²⁺ voltage-dependent currents, which were based on voltage-clamp data on thalamic neurons

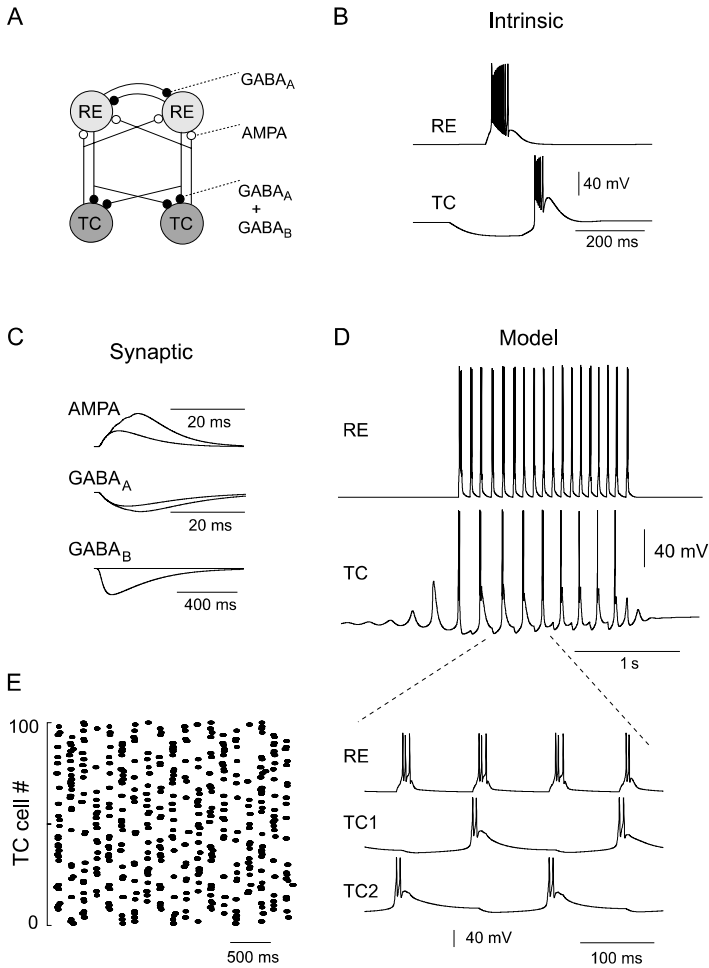

Fig. 4.11 Models of spindle oscillations as a reciprocal interaction between thalamocortical and thalamic reticular cells. **A.** Circuit of interconnected thalamocortical (TC) and thalamic reticular (RE) neurons with different receptor types. **B.** Models of the intrinsic properties of thalamic neurons. **C.** Models of the synaptic receptor types mediating their interactions. **D.** Computational model of spindle oscillations in circuits of interconnected TC and RE cells. The *expanded trace below* shows the phase relations of the two cell types. **E.** Phase relations of TC cells during spindle oscillations in a different computational model. Panels **A**, **B**, **D** are modified from Destexhe et al. (1996); Panel **C** is modified from von Krosigk et al. (1993); Panel **E** is modified from Wang et al. (1995)

(see details in Destexhe et al. 1996). These models reproduced the most salient intrinsic properties of thalamic neurons, such as the production of bursts of action potentials (Fig. 4.11B). Synaptic interactions were modeled using conductance-based kinetic models (Destexhe et al. 1994a) which were used to simulate the main receptor types (AMPA, GABA_A and GABA_B) identified in thalamic circuits (Fig. 4.11C).

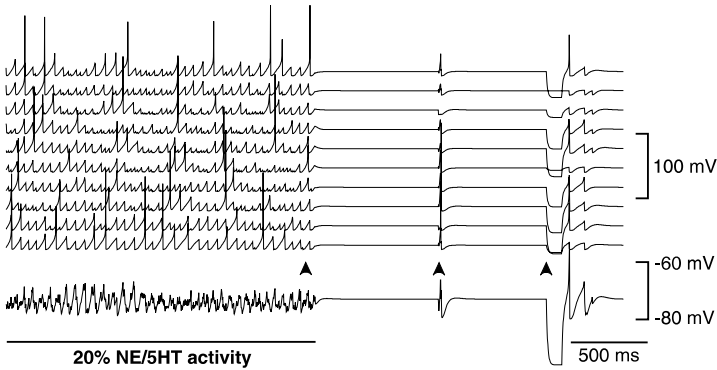

Fig. 4.12 Possible explanation for why the RE nucleus oscillates *in vivo* but not *in vitro*. Simulation of a network with 100 RE cells locally interconnected through GABAergic synapses and where the noradrenergic (NE) and serotonergic (5HT) neuromodulation was taken into account. A moderate stimulation of NE/5HT activity may be present *in vivo*, but not *in vitro*. In the presence of NE/5HT activity, the resting level of RE cells is more depolarized, and the network oscillates at a frequency of 10–16 Hz (bar), while the average membrane potential displays waxing-and-waning amplitude fluctuations. After 2 seconds (*first arrow*), all NE/5HT synaptic activity was suppressed; the resulting hyperpolarization prevented the network from sustaining oscillations. Depolarizing (*second arrow*) or hyperpolarizing (*third arrow*) current pulses injected simultaneously in all neurons (with random amplitude) could not restore spontaneous oscillations. The latter simulation might correspond to the conditions of RE cells *in vitro*. Modified from Destexhe et al. (1994d)

Under these conditions, the circuit generated 7–14 Hz spindle oscillations with the typical features described intracellularly in the different thalamic neuronal types. The model reproduced the mirror image between TC and RE cells during spindles, as well as the phase relations between cells (see Fig. 4.11D). In particular, TC cells produced bursts once every 2–3 cycles within a spindle sequence, a feature consistently observed experimentally (compare with Fig. 4.11C). More irregular behavior, similar to the experiments, was obtained in larger networks (Fig. 4.11E), or in the presence of the cortex (see below). The oscillations also showed the defining waxing-and-waning envelope of spindles; this property was due in the model to Ca^{2+} -mediated slow regulation of the I_h current (Destexhe et al. 1993), a prediction that was later verified experimentally (Luthi and McCormick 1998).

Thus, models show that taking into account the complex bursting properties of thalamic neurons, combined with their interactions through well-defined synaptic receptors, account for both RE pacemaker oscillations as well as spindle oscillations arising from TC-RE loops in which pacemaker activity in the RE nucleus is not required. The models therefore do not invalidate any of the experiments mentioned here but rather support the validity of both types of experimental results. However, it remains to be explained why the RE nucleus does not oscillate *in vitro* (Fig. 4.10A). This question was addressed by a computational model of the RE nucleus which took into account the action of neuromodulators (such as noradrenaline) in depolarizing RE cells. This model produced oscillations only when a sufficient level of neuromodulator was present (Fig. 4.12; Destexhe et al. 1994d). The differ-

ence between *in vivo* and *in vitro* preparations may therefore be explained by the limited connectivity between the RE neurons in the slice, and/or by the fact that slices lack the necessary level of neuromodulation to maintain isolated RE oscillations (Destexhe et al. 1994d). The main prediction from this model is that applying neuromodulators to slices of the RE nucleus should induce oscillations similar to those observed *in vivo*, but if sufficient connectivity is present between RE neurons. This prediction still awaits to be tested.

4.3.2 Mechanisms for Large-Scale Synchrony of Spindles

Another property of spindle oscillations is their large-scale synchrony in the brain. Figure 4.13 (Intact) shows that in the intact brain, multisite recordings from the whole anterior to posterior axis of the thalamus (spanning the occipital to frontal areas) displayed a large-scale synchrony. This synchrony is remarkable because each of the recorded thalamic nuclei is capable of generating spindle oscillations on its own. However, more interestingly, it was found that this large-scale synchrony depends on cerebral cortex (Contreras et al. 1996a). Unilateral decortication did not abolish the ability of each thalamic site to display spindle oscillations, but destroyed the large-scale coherence of oscillations (Fig. 4.13, Decorticated). In other words, different thalamic oscillators seem to be set in phase by their interaction with cerebral cortex (Contreras et al. 1996a).

It was further shown that this cortical-dependent large-scale coherence is not dependent on intracortical connections (Contreras et al. 1996a). Multisite recordings in suprasylvian cortex (area 5–7), an area known for its high density of intracortical connections, showed that the synchrony between distant sites is resistant to cutting the corticocortical connections (Fig. 4.14; Contreras et al. 1996a). Thus, the large-scale synchrony seems to depend on either callosal connections (which were unaffected in these experiments) or to reciprocal relations between cortex and thalamus. The latter hypothesis was explored by computational models.

Models of thalamocortical networks were designed, based on Hodgkin-Huxley type representations of the different classes of neurons, TC and RE cells as before, with cortical pyramidal (PY) cells and inhibitory interneurons (IN). The latter two cell types were regular-spiking and fast-spiking cells, respectively, and were modeled by Na^+ and K^+ currents for action potentials, augmented by an spike-frequency adaptation current (voltage-dependent slow K^+ current) in regular-spiking cells (see details in Destexhe et al. 1998). This current generated adapting trains of action potentials, similar to experimental observations (Connors and Gutnick 1990). Using these models, it was possible to reproduce the experimental observations only when one important property was assumed: the corticothalamic feedback on TC cells must operate mainly through inhibition (Destexhe et al. 1998). This property of “inhibitory dominance” is illustrated in Fig. 4.15. In the vast majority of TC cells recorded intracellularly *in vivo*, cortical stimulation resulted in a small amplitude EPSP followed by a large IPSP (Fig. 4.15A). In a small circuit

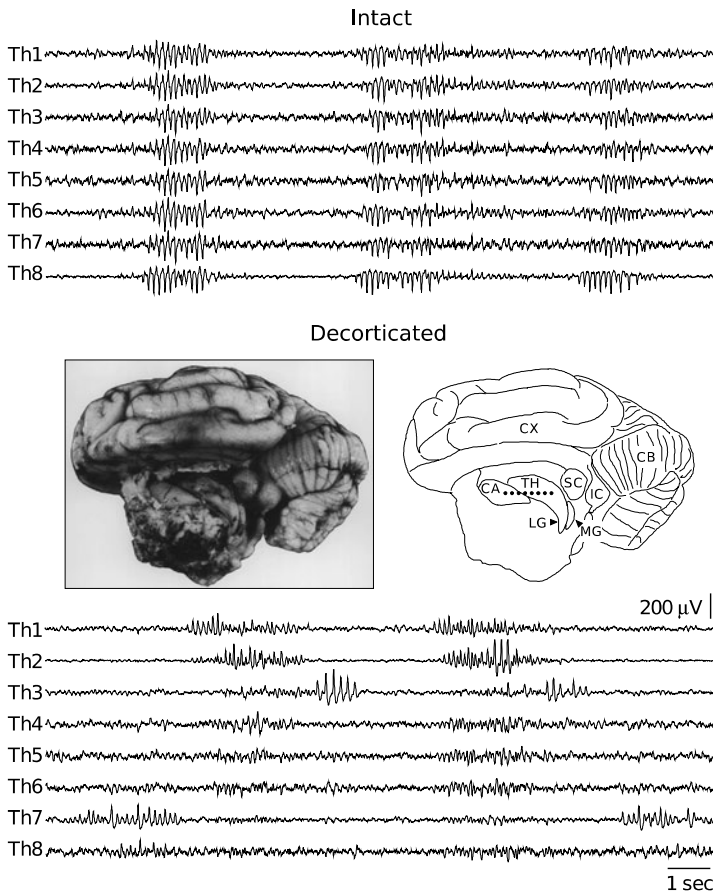

Fig. 4.13 Removal of the cerebral cortex affects the pattern of spindle oscillations in the thalamus. In an intact network under barbiturate anesthesia (*upper panel*), three spontaneous spindle sequences at 8–9 Hz and lasting for 1–3 s occurred at roughly the same time in the local field potentials recorded from eight tungsten electrodes (Th1–Th8). Tip resistances were 1 to 5 M Ω and inter-electrode distances of 1 mm. Negativity downward. Cortex was removed by suction after careful cauterization with silver nitrate (Photo), exposing the head of the caudate nucleus (CA, in the drawing), most of the dorsal thalamus (TH), the lateral geniculate body (LG), the medial geniculate body (MG), the superior (SC) and inferior colliculli (IC). Also in the photograph, and represented in the drawing at right, are the intact contralateral cortex (CX) and the cerebellum (CB). The eight electrodes were held together and their tips lowered to the positions indicated by the black dots in the drawing. The two or three most anterior electrodes crossed through the head of the caudate nucleus to reach the thalamus. After decortication (*lower panel*), recordings from approximately the same thalamic location showed that spindling continued at each electrode site, but their coincidence in time was lost. The 8-electrode configuration was positioned at different depths within the thalamus (from –2 to –6) and different lateral planes (from 2 to 5); all positions gave the same result. Modified from Contreras et al. (1996a)

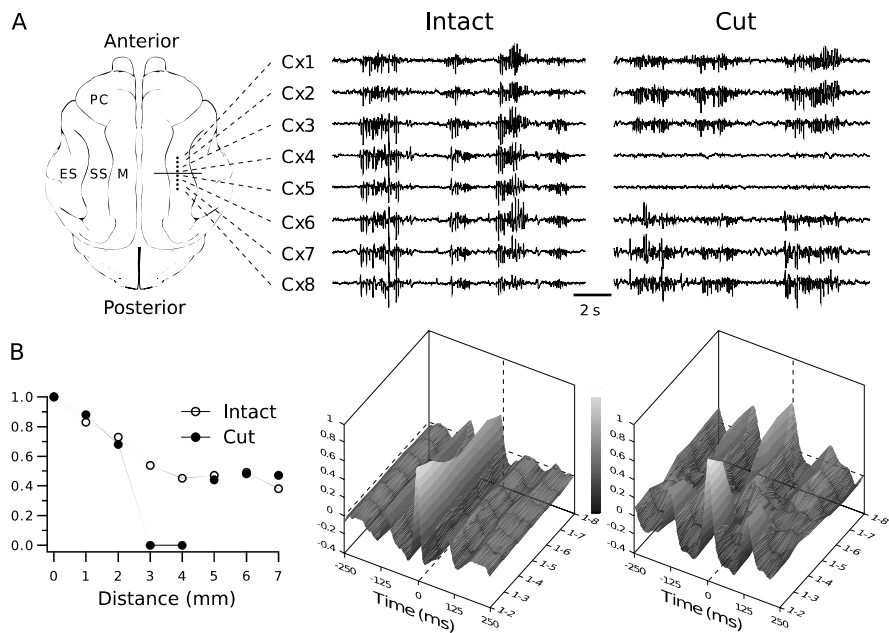

Fig. 4.14 Synchrony of spindle oscillations is not determined by intracortical connectivity. **A.** Multisite recordings from the depth (1 mm) of the suprasylvian (SS) gyrus using a similar electrode array (Cx1 to Cx8) as described in Fig. 4.13. Spontaneous spindle sequences occurred nearly simultaneously in control conditions (Intact). Following a 3 mm-deep coronal section (Cut) of the SS gyrus (*horizontal line* between electrodes Cx4 and Cx5 in the scheme), crossing laterally from the lateral aspect of the marginal gyrus (M) to the medial aspect of the ectosylvian gyrus (ES), did not disrupt simultaneity of oscillations. **B.** Synchronization was evaluated by calculating crosscorrelograms between electrode Cx1 and the others. Correlograms from 15 consecutive spindle sequences were averaged before and after the cut. The value of the averaged crosscorrelation at time zero was represented as a function of distance with respect to the first electrode (*left panel*; ● for intact cortex and ○ after cut). Averaged crosscorrelograms for each pair of electrodes were represented as surface plots for intact cortex (*middle panel*) and after cut (*right panel*). Correlation values were displayed using a gray scale ranging from -0.4 (black) to 1 (white; see *grayscale bar*). Secondary peaks around 120 ms indicate rhythmicity at 8–9 Hz. Modified from Contreras et al. (1996a)

model with two TC interconnected with two RE cells (see scheme in Fig. 4.15B), the cortical excitation of RE and TC cells reproduced the EPSP/IPSP sequences observed experimentally provided that the cortical EPSPs on RE cells were stronger than those on TC cells. In Fig. 4.15B, the conductance of AMPA-mediated cortical drive on TC and RE cells, as well as the GABA_A-mediated IPSP from RE cells were of the same order of magnitude. In this case, cortical EPSPs were shunted by reticular IPSPs and cortical stimulation did not evoke oscillations in the thalamic circuit. In contrast, when the EPSPs on TC cells had smaller conductances (5 nS compared to 100 nS), the EPSP-IPSP sequence was similar to intracellular recordings and cortical stimulation was effective in evoking oscillations (Fig. 4.15C).

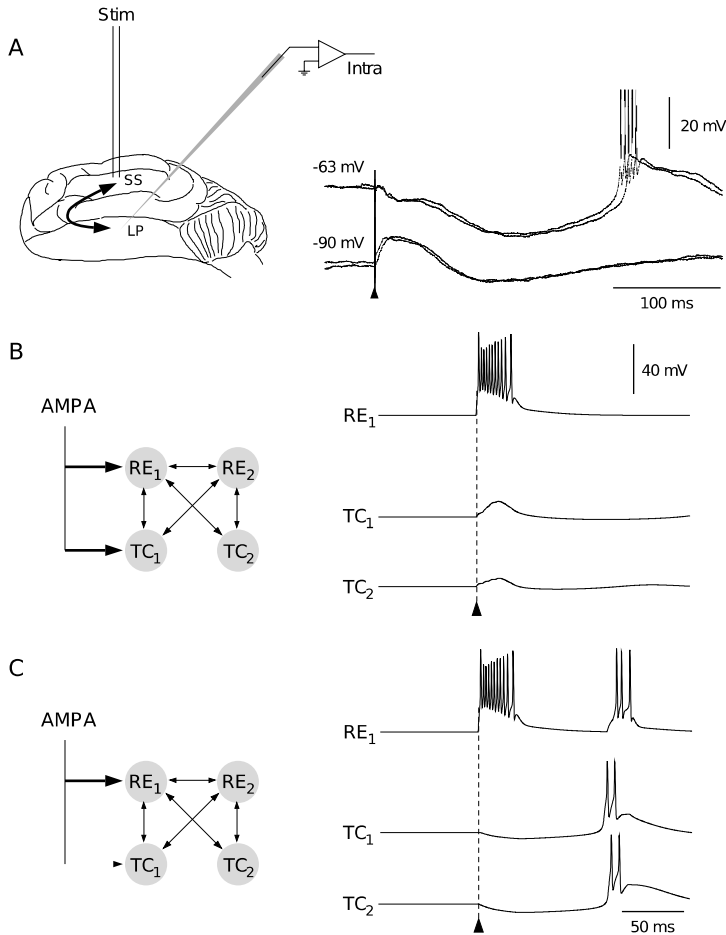

Fig. 4.15 “Inhibitory dominance” of corticothalamic feedback on thalamic relay cells. **A.** Intra-cellular recording of a TC cell in the lateral posterior (LP) thalamic nucleus while stimulating the anatomically related part of the suprasylvian cortex in cats during barbiturate anesthesia. Cortical stimulation (*arrow*) evoked a small EPSP followed by a powerful biphasic IPSP. The IPSP gave rise to a rebound burst in the TC cell. This example represented the majority of recorded TC cells. **B.** Simulation of cortical EPSPs (AMPA-mediated) in a circuit of four interconnected thalamic cells. Cortical EPSPs were stimulated by delivering a presynaptic burst of four spikes at 200 Hz to AMPA receptors. The maximal conductance was similar in TC and RE cells (100 nS in this case) and no rebound occurred following the stimulation (*arrow*). **C.** Simulation of dominant IPSP in TC cell. In this example, the AMPA conductance of stimulated EPSPs in the TC cell was reduced to 5 nS. The stimulation of AMPA receptors evoked a weak EPSP followed by strong IPSP, then by a rebound burst in the TC cells, as observed experimentally. Modified from Destexhe et al. (1998)

This property of “inhibitory dominance” was essential to reproduce the experimental observations about the large-scale synchrony of spindle oscillations. An extended thalamocortical network was simulated based on local connectivity profiles,

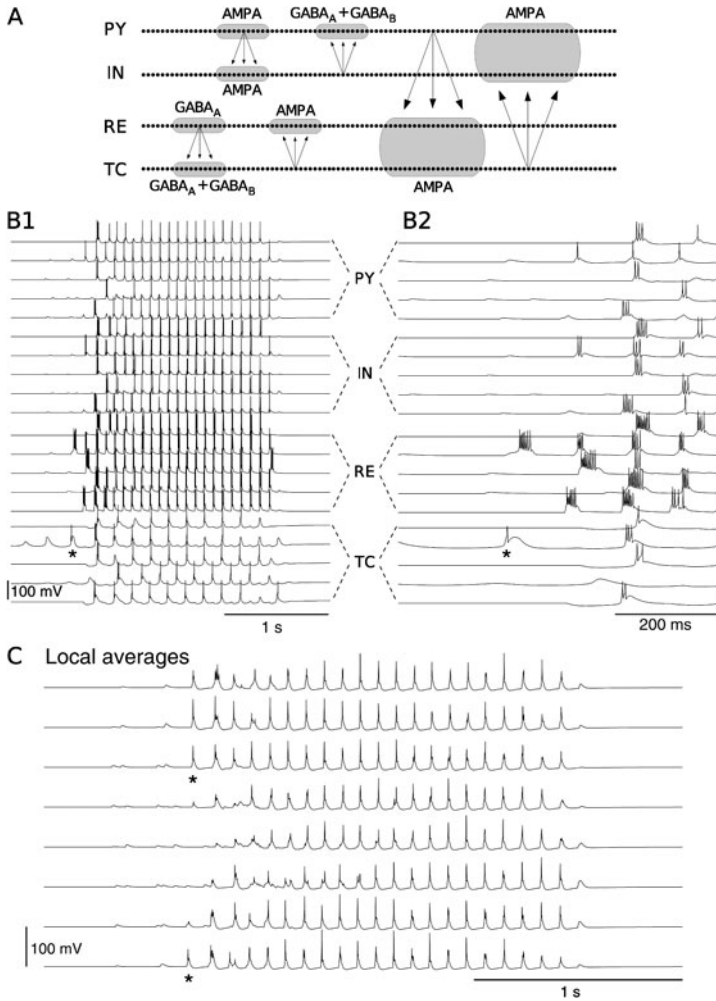

Fig. 4.16 Spontaneous spindle oscillations in a model thalamocortical network with 400 cells. **A.** Schematic connectivity. The network had four layers of PY, IN, RE and TC cells. Each cell is represented by a dot and the area to which it projects is depicted as a shaded area for a representative cell. Intrathalamic and intracortical connections were topographic with a divergence of 11 cells, whereas thalamocortical and corticothalamic projections were more extended, spanning over 21 cells. **B1.** Spontaneous spindle oscillation. Five cells of each type, equally spaced in the network, are shown (0.5 ms time resolution). The *asterisks* indicate an initiator TC cell. **B2.** Detail of spindle initiation. **C.** Locally averaged potentials. 21 adjacent PY cells, taken at eight equally spaced sites on the network, were used to calculate each average. Asterisks indicate two nearly simultaneous initiation sites. Modified from Destexhe et al. (1998)

as displayed in Fig. 4.16A. The network generated spindle oscillations which were driven by the TC-RE loops, as in the previous section. However, in the presence of the corticothalamic loops, the oscillation appeared almost synchronously over the

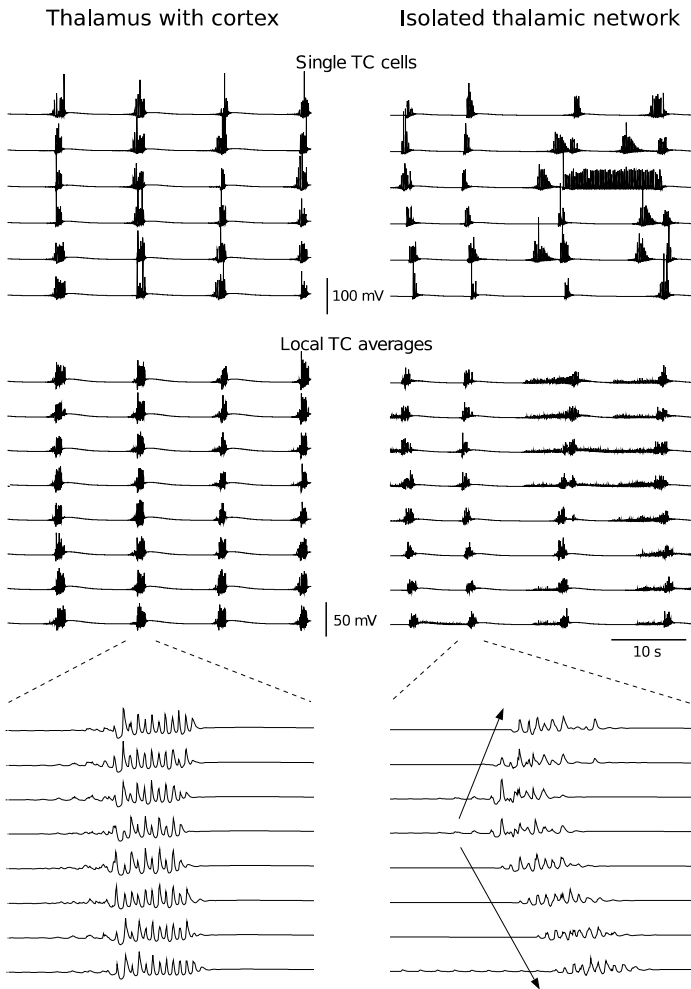

Fig. 4.17 Effects of corticothalamic feedback on the simultaneity of spindle oscillations in corticothalamic model. Spontaneous spindles are shown in the presence of the cortex (*left panels*) and in an isolated thalamic network (*right panels*) under the same conditions (same parameters as in Fig. 4.16). Single TC cells and local TC averages are shown for each case. 21 adjacent TC cells, sampled from 8 equally spaced sites on the network, were used to calculate each average. The *bottom graphs* represent averages of a representative spindle at 10 times higher temporal resolution. The near-simultaneity of oscillations in the presence of the cortex is qualitatively different from the propagating patterns of activity in the isolated thalamic network (*arrows*). Modified from Destexhe et al. (1998)

whole network (Fig. 4.16B–C), although it was initiated only in localized sites (* in Fig. 4.16B–C).

This thalamocortical network model was used to investigate how cortical feedback could organize the coherence of thalamic oscillations that were observed ex-

perimentally (Contreras et al. 1996a). We reproduced these experimental recording conditions in the model. The activity of individual thalamic cells as well as local average potentials were considerably more coherent in the presence of cortical feedback (Fig. 4.17): The *left panel* shows several spindle sequences using the same parameters as in Fig. 4.16. The *right panel* shows the same simulation with cortical cells removed. Without cortical feedback, different initiation sites for spindles were not coordinated. Some of them remained local, while others gave rise to systematic propagation of oscillations from one side of the network to the other (Fig. 4.17, bottom right panel), as observed in thalamic slices (Kim et al. 1995). This model was also able to reproduce the different patterns of spindle oscillations observed in natural sleep and anesthetized conditions (Destexhe et al. 1999b).

Thus, the thalamocortical model predicted that the main ingredient to reproduce the experiments on large-scale synchrony is that the cortex must recruit the thalamus through the RE nucleus. This property was central to explain large-scale synchrony, but also pathological states such as epileptic seizures, as investigated in the next section.

4.3.3 Consequences for Generalized Seizures

The cortical control of thalamic relay cells through dominant inhibitory mechanisms has important consequences, not only for explaining large-scale synchrony, but also to explain pathological situations such as absence epileptic seizures (Destexhe 1998). As a result of inhibitory dominance, a too strong corticothalamic feedback can over-activate thalamic GABA_B receptors and entrain the *physiologically intact* thalamus into hypersynchronous rhythms at ~ 3 Hz. This scheme may explain the genesis of hypersynchronous ~ 3 Hz rhythms that appear suddenly in the thalamocortical system. A similar type of seizure activity can be induced experimentally by increasing cortical excitability, while keeping a physiologically intact thalamus (reviewed in Gloor and Fariello 1988). The same thalamocortical model as above accounts for those experiments and can simulate seizures based on inhibitory-dominant corticothalamic feedback (Destexhe 1998). This model directly predicted that manipulating corticothalamic feedback should entrain intact thalamic circuits to generate hypersynchronous rhythms at ~ 3 Hz, a prediction which has been verified by two independent studies (Blumenfeld and McCormick 2000; Bal et al. 2000). A similar mechanism, with a different balance between GABA_A and GABA_B receptors, can also generate faster hypersynchronous rhythms (around 5–10 Hz), as observed in rat or mouse experimental models of absence seizures.

4.4 Slow Waves and Up/Down-State Dynamics

As seen in Sect. 4.2, during the deepest phases of sleep (stages 3 and 4 in humans), as well as for some anesthetized states, cortical activity is dominated by delta and slow oscillations, in a frequency range of 0.1 to 4 Hz. The intracellular correlate of

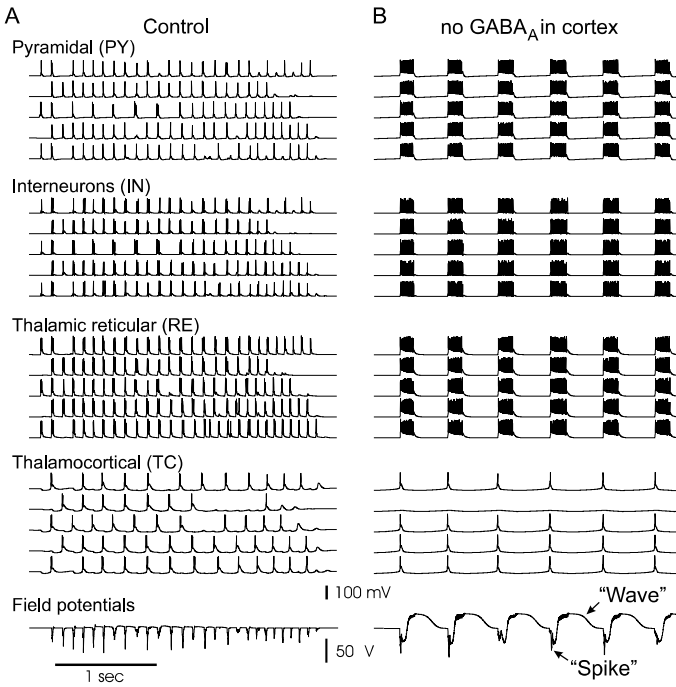

Fig. 4.18 Transformation of spindle oscillations into ~ 3 Hz oscillations with spike-and-wave field potentials by reducing cortical inhibition. **A.** Spindle oscillations in the thalamocortical network in control conditions. Five cells of each type, equally spaced in the network, are shown (0.5 ms time resolution). The field potentials, consisting of successive negative deflections at ~ 10 Hz, is shown at the bottom. **B.** Oscillations following the suppression of GABA_A-mediated inhibition in cortical cells with thalamic inhibition intact. All cells displayed prolonged discharges in phase, separated by long periods of silences, at a frequency of ~ 2 Hz. GABA_B currents were maximally activated in TC and PY cells during the periods of silence. Field potentials (*bottom*) displayed spike-and-wave complexes. Thalamic inhibition was intact in all cases. Modified from Destexhe (1998)

the slow oscillation is the alternation between depolarized states (Up-states) and hyperpolarized states (Down-states), which occurs in perfect synchrony with the EEG (Steriade 2001). An example of slow oscillation in ketamine–xylazine anesthesia is shown in Fig. 4.19A. Thus, entire cortical regions are simultaneously switching between Up- and Down-states, as also shown by multiple extracellular studies (Destexhe et al. 1999a). The origin of these oscillations seems to be cortical, because they survive extensive thalamic lesions (Steriade 2001), and they are also observed in cortical slices (Sanchez-Vives and McCormick 2000).

4.4.1 Up- and Down-States in Cortex

The observation of self-generated Up/Down-states in cortical slices (Sanchez-Vives and McCormick 2000) has motivated the search for mechanisms for Up/Down-

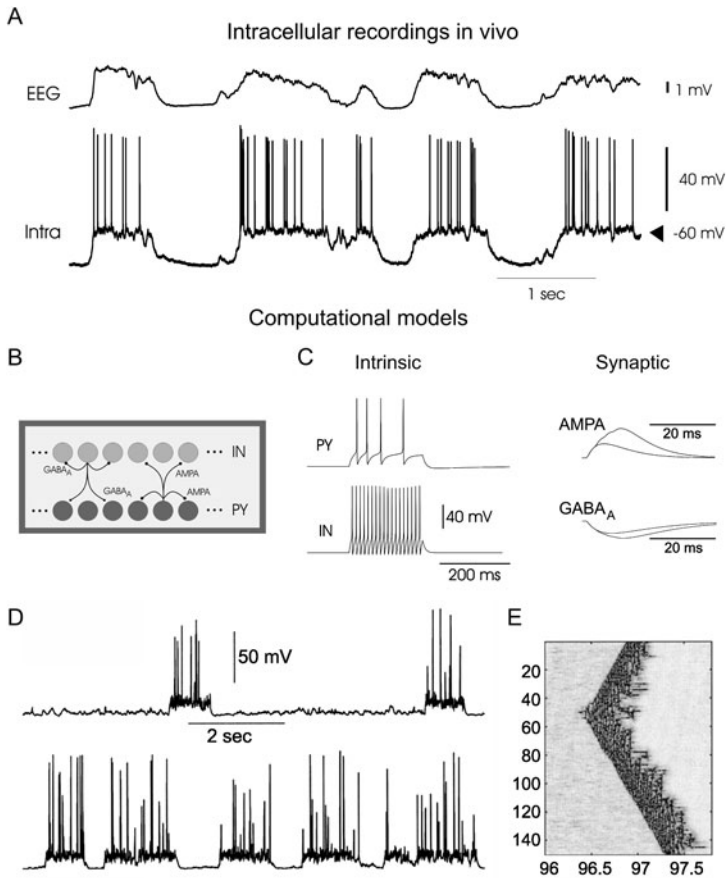

Fig. 4.19 Computational models of slow-wave oscillations in cerebral cortex. **A.** *In vivo* recordings of a morphologically identified pyramidal neuron during ketamine–xylazine anesthesia. **B.** Schematic circuit showing the two main types of cortical neurons, pyramidal cells (PY) and inhibitory interneurons (IN). Those neurons are connected via different types of synaptic receptors, with the two main types illustrated here. **C.** Models of the intrinsic properties of cortical neurons (*left*) and of the synaptic receptor types (*right*) mediating their interactions. **D.** Computational model of slow-wave oscillations arising from reverberation of activity through recurrent connections in networks of cortical circuits. The network displays Up- and Down-states with different frequency of occurrence depending on the level of spontaneous activity. **E.** Snapshot of activity in the network showing the initiation and propagation of the Up-state. **A.** Modified from Rudolph et al. (2005); **D,E.** Modified from Timofeev et al. (2000)

state generation within the cortex. Computational models were investigated based on recurrent circuits of excitatory and inhibitory cortical neurons described by Hodgkin–Huxley type models (Fig. 4.19B). The two main electrophysiological types of cortical neurons were considered, as well as their synaptic interactions through glutamate (AMPA) and GABAergic (GABA_A) receptors (Fig. 4.19C). These models showed that Up-states can be generated by recurrent excitatory

and inhibitory connections, which self-sustain the activity (Fig. 4.19D). Different exact mechanisms by which Up-states begin and terminate have been proposed. Up-states can start either by the interaction between subthreshold Na currents (persistent Na current) and miniature excitatory synaptic potentials (Timofeev et al. 2000). Another possible mechanism is to consider spontaneously active cells that would initiate the wave of activity in the network (Compte et al. 2003). In a third mechanism, Up states initiate due to self-sustained network activity (Destexhe 2009). So far, none of these mechanisms has been verified experimentally. The termination of the Up-state is apparently due to a progressive run down of synaptic activity, as indicated by conductance measurements (Contreras et al. 1996b). What causes this run down could be either an intrinsic property, such as the progressive build-up of a slow potassium conductance (Compte et al. 2003; Destexhe 2009), as the metabolically dependent K_{ATP} current demonstrated to control the termination of Up-states in cortical slices (Cunningham et al. 2006), or depression of excitatory synapses. Both hypotheses are supported by experimental data, and are also consistent with the refractoriness of the Up-states found in slices (Sanchez-Vives and McCormick 2000); this refractoriness could be due to the potassium conductance, or recovery from synaptic depression.

Another property of Up/Down-states is that the duration of the Down is proportional to network size. Down-states are typically short *in vivo* (a few hundred ms) while they can last up to 20 seconds in slices. Cutting cortical slabs of different sizes *in vivo* confirmed that the Down-state duration varies inversely proportional to slab size (Timofeev et al. 2000). Here again, this property is consistent with the three mechanisms of initiation outlined above, as they all depend on coincident activation of either miniature or spontaneously active cells, both of which will occur more often in large networks.

A final property of slow waves is that the Up-states clearly show propagating properties *in vitro* (Sanchez-Vives and McCormick 2000). This propagation can be reproduced by computational models (Fig. 4.19E), assuming that synaptic connections are made locally in the cortical network. In contrast, there is evidence that Up-states are highly synchronized *in vivo*, because the local EEG is always phase locked with intracellular activity (Fig. 4.19A). Multiple extracellular recordings in natural sleep also demonstrated that the Up-states of slow waves are highly synchronized across distances up to 7 mm in cortex (Destexhe et al. 1999a; see Sect. 4.2).

Another type of model was proposed more recently (Destexhe 2009) based on nonlinear integrate-and-fire (IF) neurons. These models are simpler than Hodgkin-Huxley type models, but still can reproduce the main intrinsic properties of thalamic and cortical cells (Fig. 4.20). In particular this so-called adaptative exponential IF model (Brette and Gerstner 2005) can reproduce the rebound bursting activity of thalamic TC and RE neurons, as well as the classical regular-spiking and fast-spiking patterns.

Using this model, Up- and Down-state dynamics could be simulated by a two-layer cortical network (Fig. 4.21). The Up–Down-state dynamics emerged from the interaction of two layers, Layer B was a network displaying spontaneous activity (as a self-sustained state), while Layer A had no spontaneous activity. The Up-state

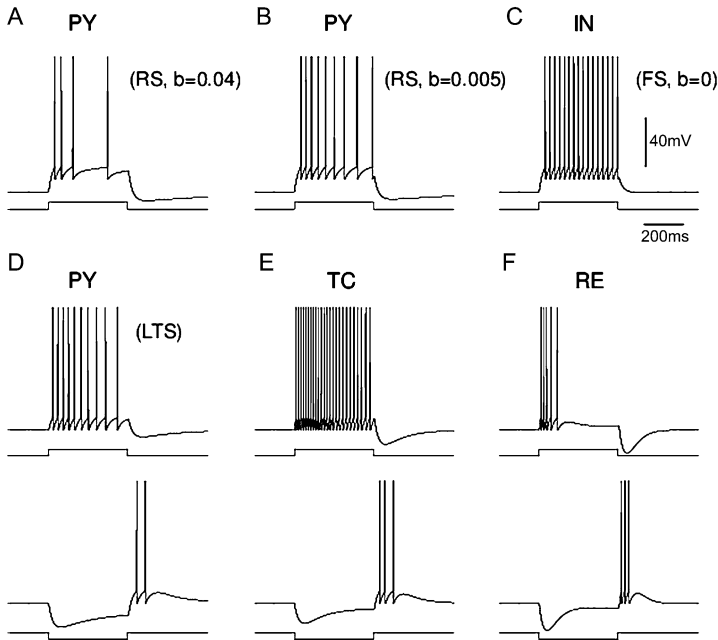

Fig. 4.20 Different classes of cortical and thalamic neurons modeled by the adaptive exponential integrate-and-fire model. **A.** Regular-spiking (RS) pyramidal (PY) neuron with strong adaptation. **B.** RS PY neuron with weak adaptation. **C.** Fast-spiking (FS) inhibitory (IN) interneuron with negligible adaptation. **D.** Low-threshold spike (LTS) PY cell. **E.** Thalamocortical (TC) neuron. **F.** Thalamic reticular (RE) neuron. In all cases, the response to a depolarizing current pulse of 0.25 nA is shown on top. For **D–F**, the *bottom curves* show the response to a hyperpolarizing current pulse of -0.25 nA. The units of the adaptation parameter b in **A–C** are nA. Modified from Destexhe (2009)

activity ceased due to adapting currents in PY cells in Layer A, leading to a Down-state, which ended by the spontaneous firing of some of the cells in Layer B, which restarted the next Up-state. This model is in agreement cortical slices where it was shown that Up-states always start in Layer 5 and subsequently propagate to other layers (Sanchez-Vives and McCormick 2000). The model displayed Up–Down-state dynamics where the Down-state was nearly simultaneous in all cell types, with no specific built-in mechanism to generate this synchronized activity. Contrary to previous models, the Up–Down-state dynamics was entirely self-generated by the network, without the need for external input or spontaneously active cells (see details in Destexhe 2009).

4.4.2 Thalamocortical Models of Up- and Down-States

The two-layer model of Up–Down-state shown in the preceding section was extended into a thalamocortical model. In this model, the cortical layer was identical

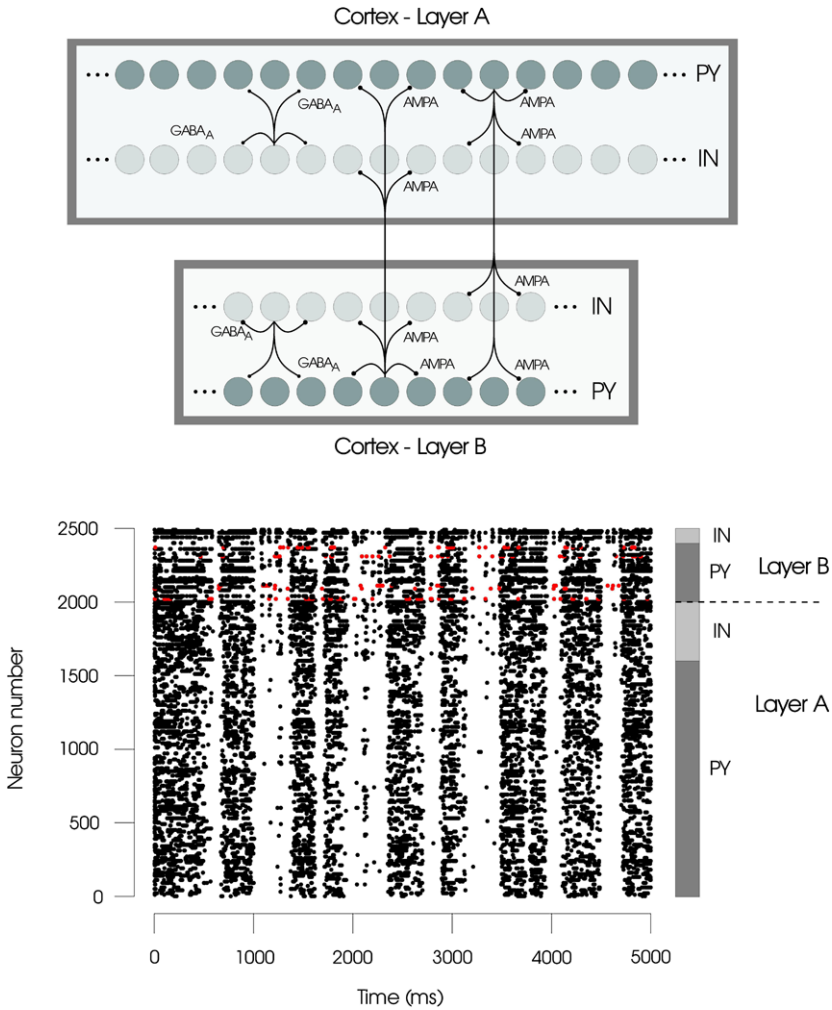

Fig. 4.21 Up/Down-state dynamics in a two-layer cortex model with LTS cells. *Top*: Scheme of connectivity between two networks of $N = 2000$ (Layer A) and $N = 500$ (Layer B) neurons. Layer B had 10% LTS cells and was capable of displaying self-sustained asynchronous irregular (AI) states. *Bottom*: Raster of the activity during 5 seconds (LTS cells shown in red). The stimulation of the network started at $t = 0$ and lasted 50 ms, leading to self-sustained Up/Down-state dynamics ($CV_{ISI} = 2.49$, $CC = 0.069$). The interlayer connectivity was only excitatory and had a connection probability of 1%. Modified from Destexhe (2009)

to Layer A in the cortical model, and the thalamic network displayed spontaneous activity, playing a similar role as Layer B above (Fig. 4.22). As in the two-layer cortical model, the Up-states ceased due to adapting currents in PY cells, leading to a Down-state, which occurred nearly simultaneously in the whole network. The dynamics was also entirely self-generated with no external input (see Destexhe 2009).

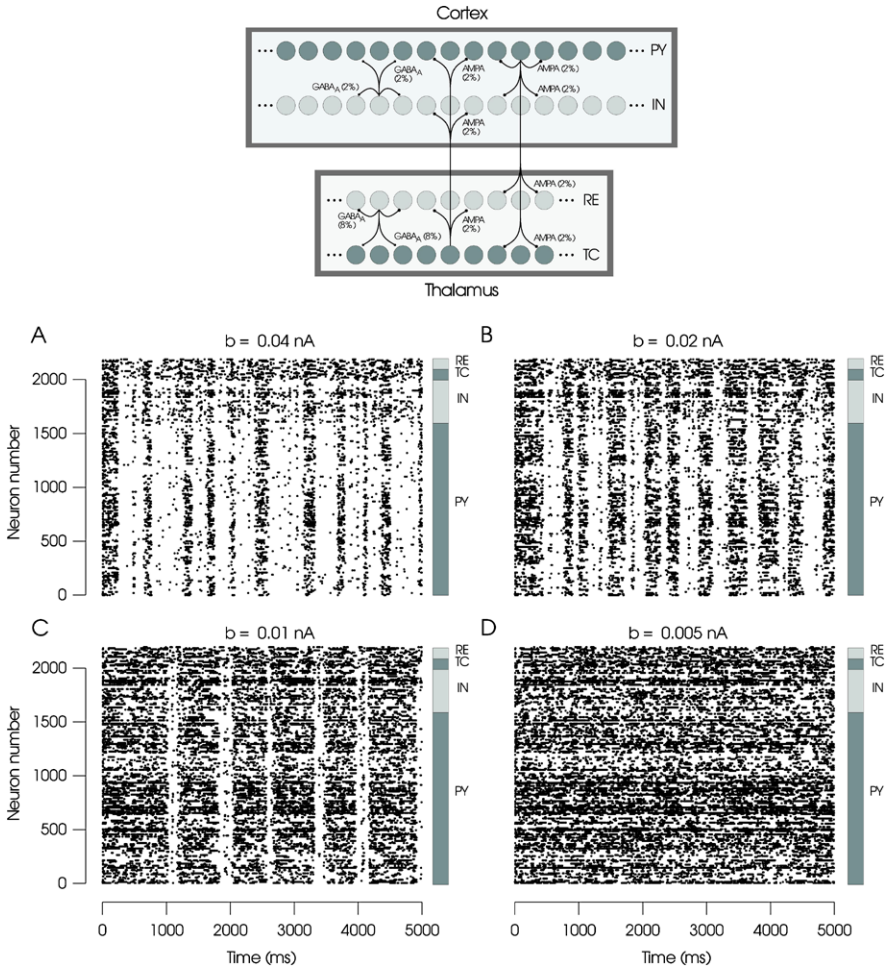

Fig. 4.22 Self-sustained irregular and Up/Down-states in a thalamocortical network of adaptive exponential IF neurons. *Top:* Scheme of connectivity of the thalamocortical network. The network had four layers of cortical pyramidal (PY), cortical interneurons (IN), thalamic reticular (RE) and thalamocortical (TC) relay cells. Each cell is represented by a *filled circle* (dark gray = excitatory cells; light gray = inhibitory cells), and synaptic connections are schematized by *arrows*. *Bottom panels:* From **A** to **D**, the same model was used (2200 cells total, 1600 PY, 400 IN, 100 TC and 100 RE cells), but with different strengths of adaptation (from $b = 0.04$ nA in **A** to $b = 0.005$ nA in **D**). In all rasters, only 10% of cells are shown for each cell type, and the four layers of cells are indicated on the *right*. For the AI state in **D**, cortical neurons were characterized by a mean firing rate of 44 Hz, a coefficient of variation of $CV_{ISI} = 2.45$ and a pairwise correlation of $CC = 0.004$. Modified from Destexhe (2009)

One of the features of interest of Up-states is that this activity is very similar to that during the wake state (reviewed in Destexhe et al. 2007). This is supported by several observations. First, during the Up-state, the EEG is of low-amplitude

and fast activity, similar to desynchronized EEG. Second, extracellular recordings showed that the Up-states obey the same dynamics of firing, have similar local correlations, and display similar relations between EEG and unit firing, as during wakefulness (Destexhe et al. 1999a). Third, stimulating nuclei participating to the ascending arousal system induces periods of desynchronized EEG, which correspond intracellularly to prolonged Up-states. Fourth, conductance measurements from intracellular recordings in anesthetized or EEG-activated states show similar conductance patterns during both states.¹ Fifth, computational models of Up/Down-states and of activated states in cortical circuits suggest that both can be generated by similar mechanisms (see below).

The thalamocortical model of Up–Down-states was used to simulate the transition to the sustained and irregular firing activity during wakefulness. Self-sustained irregular states similar to activated states have been simulated by various models (reviewed in Vogels et al. 2005). Only a few models, however, provided the transition from Up/Down-states to activated states (Brunel 2000; Bazhenov et al. 2002; Compte et al. 2003). For all of such models, Up-states and activated states are very similar and differ only by the level of excitability of the neurons (mostly by down-regulating potassium conductances). Some of these models were confronted to input resistance or conductance measurements and reproduced qualitatively the values measured experimentally. The fact that Up-states and activated states can be simulated using the same models with few differences is another indication that those two states stem from similar network activity (see above).

4.5 Discussion

In this chapter, we have reviewed some selected aspects of the relation between cellular and global (EEG, LFP) activities during different types of sleep oscillations. We summarize below the mechanisms of these oscillations, and their possible physiological role.

4.5.1 Cellular Mechanisms of Sleep Oscillations

Sleep spindle oscillations were investigated by experiments and modeling at different levels. At the cellular level, thalamic neurons produce bursts of action potentials in synchrony during spindles. Despite the fact that this represents an unusually strong input to cortex, cortical pyramidal neurons display surprisingly low levels

¹The absolute conductance is lower in activated states compared to Up-states, but both states are characterized by similar ratios between excitatory and inhibitory conductances (Rudolph et al. 2005).

of discharge. It was shown that the sleep spindles recruit strong inhibitory conductances in cortex, which explains this moderate level of discharge (Contreras et al. 1997).

At the level of the mechanisms of generation of spindles by thalamic circuits, two hypotheses were proposed based on experiments. First, *in vivo* experiments support the “RE pacemaker” hypothesis for spindle generation (Steriade et al. 1997). Different models point to the fact that such a pacemaker in the reticularis is definitely possible (Wang and Rinzel 1993; Destexhe et al. 1994c; Bazhenov et al. 1999), but it requires a critical amount of connectivity and sufficient depolarization of RE cells, two conditions which may not be met in slices. Second, the “TC-RE loop” hypothesis, first proposed by Scheibel and Scheibel (1966, 1967), was subsequently found and demonstrated in thalamic slices (von Krosigk et al. 1993). Models also found that this mechanism is possible (Wang et al. 1995; Destexhe et al. 1996). So far, only one model addressed the question of the compatibility between all experiments (Destexhe et al. 1994d), and predicted that neuromodulation and depolarization of RE cells could explain the contrasting observations, a prediction which still awaits to be tested experimentally.

At the level of the thalamocortical system, *in vivo* recordings demonstrated a remarkable large-scale synchrony, which was dependent on the integrity of the thalamocortical system (Contreras et al. 1996a). Models could reproduce these observations based on the property of “inhibitory dominance” of corticothalamic feedback (Destexhe et al. 1998). This property was shown to be present in the majority of intracellularly recorded thalamic cells, and it was subsequently demonstrated that the cortical synapses are much stronger in RE cells compared to TC cells (Golshani et al. 2001). Interestingly, this inhibitory-dominance also can explain the emergence of hypersynchronous rhythms at ~ 3 Hz following increased cortical excitability (Destexhe 1998). This model predicted that stimulation of corticothalamic fibers in slices should be able to “force” the intact thalamic circuit to produce synchronized ~ 3 Hz oscillations. This prediction was successfully tested by two independent studies (Blumenfeld and McCormick 2000; Bal et al. 2000).

Thus, at this point, the current mechanism for large-scale synchronization of spindles through successive recruitment loops between thalamus and cortex accounts for a large body of experiments, including the genesis of pathological states such as generalized seizures. It must be noted, however, that this synchronizing mechanism was only investigated based on experiments in a cortical area of about 1 cm (area 5–7), but remains to be investigated for the synchrony over the whole brain. It is likely that other factors, such as callosal connections or non-specific thalamic nuclei, must be considered to fully account for large-scale synchrony. Indeed, a strong role for the intracortical connectivity was emphasized by models (Destexhe et al. 1999b).

Another type of sleep oscillation, the slow oscillation (0.1–4 Hz), including the delta frequency range, was also intensely investigated by experiments and models. The cellular correlates of slow waves is a “synchronized silence” in the firing of cortical and thalamic cells, a feature which was first identified in anesthetized states

and subsequently in natural sleep (Steriade et al. 1993a, 1993b, 1993c). The network alternates between “Down-states”, associated with neuronal silence and membrane hyperpolarization, and “Up-states” where cells are depolarized and display tonic irregular firing similar to the activity during wakefulness.

The genesis of the slow rhythm is more complex than spindles, because multiple “pacemakers” were found for this type of oscillation. The finding of a slow oscillation in cortical slices (Sanchez-Vives and McCormick 2000) proves that cortical circuits can autonomously generate this type of oscillation. Note that the characteristics of the slow oscillation *in vitro*, such as the respective length of Up- and Down-states, is markedly different from *in vivo*, although the size of the network may explain this effect. Nevertheless, different computational models showed that cortical circuits can generate either self-sustained asynchronous irregular states, or Up–Down-state patterns

The thalamus has also been shown to generate Up- and Down-state patterns, as an intrinsic property of thalamic neurons in the presence of glutamate metabotropic receptor antagonists (Hughes et al. 2002; Blethyn et al. 2006). It is at present not clear to what extent this conditional thalamic pacemaker plays a role in the Up–Down-state patterns seen *in vivo*. Dual intracellular recordings indicate that thalamic bursts tend to occur just before the onset of the Up-state in cortex (Contreras and Steriade 1995). However, the lack of any obvious effect of massive thalamic lesions on the slow oscillation recorded *in vivo* (Steriade et al. 1993b) suggests that thalamic slow oscillations have a limited participation in the generation or maintenance of slow oscillations in cortex.

Concerning the transition from slow waves to wakefulness, awakening of the animal, or stimulation of the ascending activating system under anesthesia induces a transition from Up/Down-states to sustained Up-states with desynchronized EEG (Fig. 4.23A). This transition can be mimicked in the thalamocortical model by reducing the adaptation in pyramidal neurons (Fig. 4.23B). This is consistent with the action of neuromodulators implicated in arousal, such as acetylcholine or noradrenaline, which block or reduce the K^+ conductances responsible for spike-frequency adaptation (McCormick 1992). However, these state transitions are qualitative as not all experimental measurements have been taken into account, for example the conductance measurements in natural wake and sleep states (Rudolph et al. 2007) should be included in models. Reproducing the correct conductance state in individual neurons requires large network sizes (El Boustani et al. 2007; Kumar et al. 2008), and it should be done in a near future.

4.5.2 Possible Role of Sleep Oscillations

From the experiments and biophysical models outlined here, and in particular two of the main sleep oscillations, spindles and slow waves, we can speculate about their possible role.

One interesting aspect of sleep spindles is their relatively low level of discharge. Investigating this issue, it was found that reversing inhibition leads to powerful

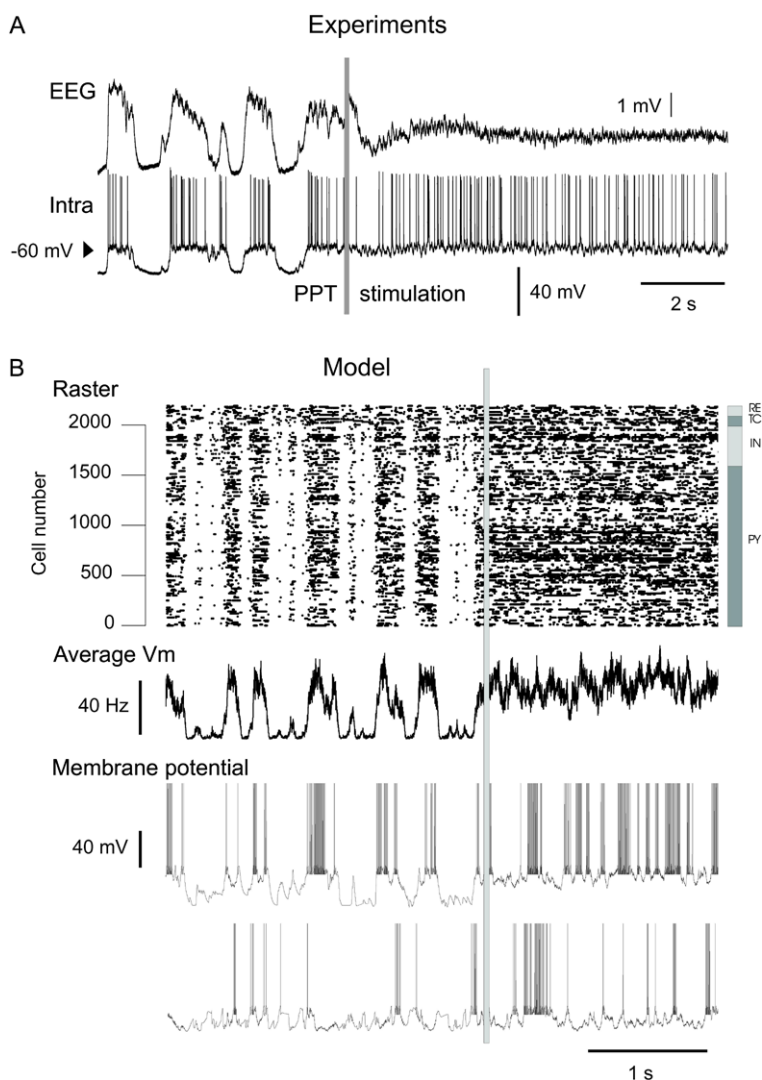

Fig. 4.23 Experiments and model of the transition from Up/Down- to activated states. **A.** Transition from Up/Down-state dynamics to an activated state, evoked by stimulation of the pedunculo-pontine tegmentum (PPT) in an anesthetized cat. The two traces, respectively, show the EEG and intracellular activity recorded in parietal cortex. **B.** Similar transition obtained by changing the value of b from 0.02 nA to 0.005 nA (*gray line*). All other parameters were identical to Fig. 4.22. Panel **A** modified from Rudolph et al. (2005). Panel **B** modified from Destexhe (2009)

bursts of action potentials, therefore revealing a powerful inhibition during spindles in cortex (Contreras et al. 1997). Computational models drawn based on these data concluded that spindles are characterized by strong excitatory and inhibitory conductances. Because of the high density of excitatory synapses in dendrites, it was

estimated that the dendrites are very depolarized during spindles, while the soma is kept hyperpolarized by inhibition. This dendritic depolarization is characteristic to spindles, so the physiological role of spindles may be related to this unusual event. Because depolarization is an efficient way to induce calcium entry, it was speculated that the role of spindles may be to induce repetitive volleys of massive calcium entry in pyramidal neurons (Contreras et al. 1997), a signal which may be ideal to activate specific molecular gates such as protein-kinase A, perhaps in relation to synaptic plasticity (Destexhe and Sejnowski 2001).

Concerning the slow waves, as mentioned above, the Up-states during slow waves share many different features of the sustained activity during wakefulness, and thus, Up-states can be viewed as brief periods of activity in which network dynamics are very similar to the dynamics during wakefulness. This is consistent with the fact that Up-states would represent “replayed” events that have occurred previously during the wake state (Destexhe et al. 1999a). There is abundant experimental evidence for such a replay during sleep from birds to higher mammals (see overview in Ribeiro et al. 2004).

These observations lead to the following speculative scenario. During wakefulness, latent memories are formed throughout the cortex, together with links to the hippocampal formation that allow top-down retrieval to occur. During the early stages of sleep, spindle oscillations would mobilize the molecular machinery needed for memory consolidation. In the deeper phases of slow-wave sleep, during the brief periods of wake-like activities (Up-states), the hippocampal formation would activate latent memories stored in the neocortex (“replay”) and induce permanent changes in intrinsic or synaptic conductances. This hypothetical mechanism of memory consolidation during sleep is consistent with all electrophysiological characteristics of sleep oscillations, and it predicts that special correlations between hippocampal and cortical activities should occur during the Up-states of slow waves (see details in Destexhe and Sejnowski 2001). Such correlations have been found recently between cortical slow waves (Up-states) and hippocampal sharp waves (Sirota et al. 2003; Battaglia et al. 2004; Peyrache et al. 2009).

This replay during sleep was investigated more quantitatively by computing the degree of similarity of the spatiotemporal patterns of spikes produced in sleep and prior wakefulness in rats during exploratory behavior (Peyrache et al. 2009). This degree of similarity, called “reactivation strength”, was found to be higher in the slow-wave sleep period immediately following the novel experience. In particular, the reactivation strength was computed in relation to spindle waves and Up/Down-state events. Interestingly, the peak in reactivation strength was clearly correlated with slow-waves events, both delta and slow oscillations (Fig. 4.24A–B, top panels). There was also a strong reactivation correlated with spindle waves; in this case reactivation tended to occur before the spindle (Fig. 4.24C, top panels). In all cases, the increase of reactivation strength was strongly correlated with the occurrence of hippocampal sharp waves (Fig. 4.24, middle panels) but not with the mean firing rate of the ensemble of recorded cortical neurons (Fig. 4.24, bottom panels).

These results clearly show that there is a “replay” of spike patterns during slow-wave sleep, and more specifically in relation with the different types of sleep slow

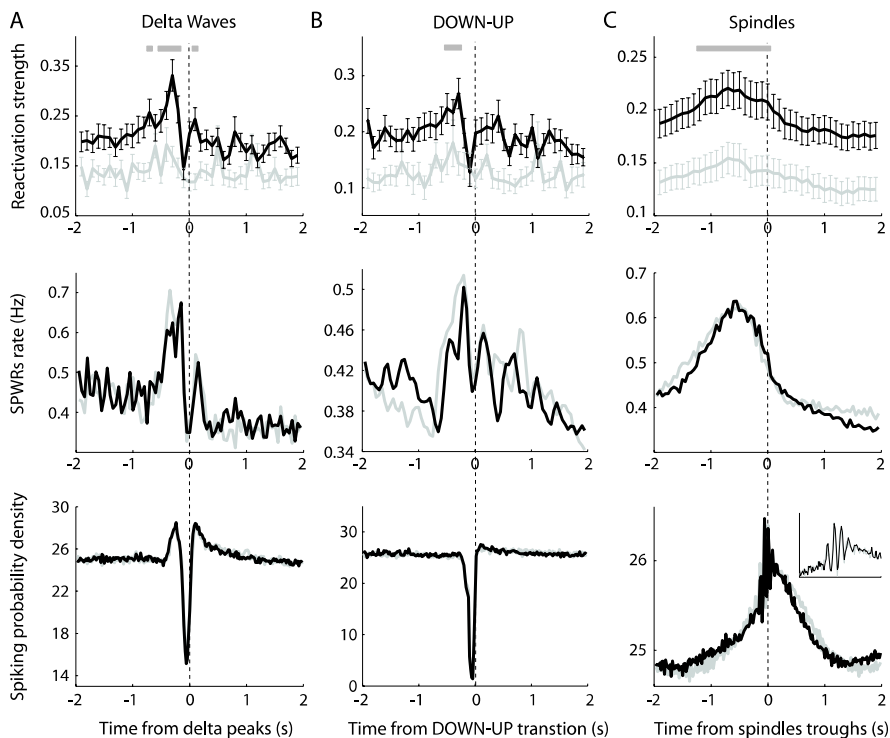

Fig. 4.24 Reactivation strength in rat prefrontal cortex related to sleep spindles and slow oscillations following a learning task. Prefrontal cortical neurons and LFPs were recorded with multiple tetrodes in chronically implanted rats, together with LFP electrodes in the anatomically related part of the hippocampus (see details in Peyrache et al. 2009). **A.** *Top*: reactivation strength relative to the depth-negative peak of delta waves, for sleep periods preceding (Pre, gray) and following (Post, black) the task. Gray bars indicate significantly ($P > 0.001$, t -test) higher reactivation strengths for signal components during post SWS with respect to baseline. *Middle*: cross-correlogram of the occurrence of hippocampal sharp waves (SPW) relative to delta peaks. SPWs tended to occur more frequently just before delta peaks, similar to reactivation. *Bottom*: spiking probability density of multi-unit activity relative to delta waves and averaged over all recording sessions. Gray, pre SWS; black, post SWS. Prefrontal cells showed a strong decrease in firing at the time of the delta peak, preceded and followed by activity increases. **B.** Same plot as in **A**, but centered on putative DOWN to UP state transitions (as defined by population average firing rate). Results are comparable with those shown in **A**, except for spiking probability, which only showed a marked deflection during the Down-state. **C.** Same plots as in **A**, but centered on spindle troughs (depth-LFP negative peaks). The reactivation strength was significantly higher ($P > 0.05$) for over 1 s before spindles (*top*) and this was clearly correlated to the occurrence of hippocampal SPWs (*middle*). Modified from Peyrache et al. (2009)

waves. This replay of cortical spike patterns is correlated with the sharp waves of hippocampus, which are one of the main types of hippocampal electrical activity during slow-wave sleep (Buzsaki 2006). This analysis constitutes direct evidence that there is a special dialogue between hippocampus and cerebral cortex during slow-wave sleep, and that this dialogue is related to the consolidation of novel in-

formation. It is presently not clear what are the exact mechanisms behind such a dialogue, but it constitutes an exciting challenge for future experimental and theoretical studies.

Acknowledgements Research supported by CNRS, ANR (HR-CORTEX grant), the European Community (FET grants FACETS FP6-015879, BRAINSCALES FP7-269921) and the NIH (R01EY020765).

References

- Bal T, Debay D, Destexhe A (2000) Cortical feedback controls the frequency and synchrony of oscillations in the visual thalamus. *J Neurosci* 20(7478):7478–7488
- Battaglia FP, Sutherland GR, McNaughton BL (2004) Hippocampal sharp wave bursts coincide with neocortical “up-state” transitions. *Learn Mem* 11:697–704
- Bazhenov M, Timofeev I, Steriade M, Sejnowski TJ (1999) Self-sustained rhythmic activity in the thalamic reticular nucleus mediated by depolarizing GABA_A receptor potentials. *Nat Neurosci* 2:168–174
- Bazhenov M, Timofeev I, Steriade M, Sejnowski TJ (2002) Model of thalamocortical slow-wave sleep oscillations and transitions to activated states. *J Neurosci* 22:8691–8704
- Berger H (1929) Über den zeitlichen verlauf der negativen schwankung des nervenstroms. *Arch Ges Physiol* 1:173
- Blethyn KL, Hughes SW, Tóth TI, Cope DW, Crunelli V (2006) Neuronal basis of the slow (<1 Hz) oscillation in neurons of the nucleus reticularis thalami *in vitro*. *J Neurosci* 26:2474–2486
- Blumenfeld H, McCormick DA (2000) Corticothalamic inputs control the pattern of activity generated in thalamocortical networks. *J Neurosci* 20:5153–5162
- Brette R, Gerstner W (2005) Adaptive exponential integrate-and-fire model as an effective description of neuronal activity. *J Neurophysiol* 94:3637–3642
- Brunel N (2000) Dynamics of sparsely connected networks of excitatory and inhibitory spiking neurons. *J Comput Neurosci* 8:183–208
- Buzsáki G (2006) *Rhythms of the Brain*. Oxford University Press, London
- Compte A, Sanchez-Vives MV, McCormick DA, Wang XJ (2003) Cellular and network mechanisms of slow oscillatory activity (<1 Hz) and wave propagations in a cortical network model. *J Neurophysiol* 89:2707–2725
- Connors BW, Gutnick MJ (1990) Intrinsic firing patterns of diverse neocortical neurons. *Trends Neurosci* 13:99–104
- Contreras D, Steriade M (1995) Cellular basis of EEG slow rhythms: a study of dynamic corticothalamic relationships. *J Neurosci* 15:604–622
- Contreras D, Destexhe A, Sejnowski TJ, Steriade M (1996a) Control of spatiotemporal coherence of a thalamic oscillation by corticothalamic feedback. *Science* 274:771–774
- Contreras D, Timofeev I, Steriade M (1996b) Mechanisms of long lasting hyperpolarizations underlying slow sleep oscillations in cat corticothalamic networks. *J Physiol* 494:251–264
- Contreras D, Destexhe A, Steriade M (1997) Intracellular and computational characterization of the intracortical inhibitory control of synchronized thalamic inputs *in vivo*. *J Neurophysiol* 78:335–350
- Cunningham MO, Pervouchine DD, Racca C, Kopell NJ, Davies CH, Jones RS, Traub RD, Whittington MA (2006) Neuronal metabolism governs cortical network response state. *Proc Natl Acad Sci USA* 103:5597–5601
- Destexhe A (1992) Nonlinear dynamics of the rhythmical activity of the brain. PhD thesis, Université Libre de Bruxelles, Brussels, Belgium. http://cns.iaf.cnrs-gif.fr/alain_thesis.html
- Destexhe A (1998) Spike-and-wave oscillations based on the properties of GABA_B receptors. *J Neurosci* 18:9099–9111

- Destexhe A (2009) Self-sustained asynchronous irregular states and up/down states in thalamic, cortical and thalamocortical networks of nonlinear integrate-and-fire neurons. *J Comput Neurosci* 27:493–506
- Destexhe A, Sejnowski TJ (2001) *Thalamocortical Assemblies*. Monographs of the Physiological Society. Oxford University Press, London
- Destexhe A, Sejnowski TJ (2003) Interactions between membrane conductances underlying thalamocortical slow-wave oscillations. *Physiol Rev* 83:1401–1453
- Destexhe A, Babloyantz A, Sejnowski TJ (1993) Ionic mechanisms for intrinsic slow oscillations in thalamic relay neurons. *Biophys J* 65:1538–1552
- Destexhe A, Contreras D, Sejnowski TJ, Steriade M (1994a) A model of spindle rhythmicity in the isolated thalamic reticular nucleus. *J Neurophysiol* 72:803–818
- Destexhe A, Contreras D, Sejnowski TJ, Steriade M (1994b) Modeling the control of reticular thalamic oscillations by neuromodulators. *Neuroreport* 5:2217–2220
- Destexhe A, Mainen ZF, Sejnowski TJ (1994c) An efficient method for computing synaptic conductances based on a kinetic model of receptor binding. *Neural Comput* 6:14–18
- Destexhe A, Mainen ZF, Sejnowski TJ (1994d) Synthesis of models for excitable membranes, synaptic transmission and neuromodulation using a common kinetic formalism. *J Comput Neurosci* 1:195–230
- Destexhe A, Bal T, McCormick DA, Sejnowski TJ (1996) Ionic mechanisms underlying synchronized oscillations and propagating waves in a model of ferret thalamic slices. *J Neurophysiol* 76:2049–2070
- Destexhe A, Contreras D, Steriade M (1998) Mechanisms underlying the synchronizing action of corticothalamic feedback through inhibition of thalamic relay cells. *J Neurophysiol* 79:999–1016
- Destexhe A, Contreras D, Steriade M (1999a) Cortically-induced coherence of a thalamic-generated oscillation. *Neuroscience* 92:427–443
- Destexhe A, Contreras D, Steriade M (1999b) Spatiotemporal analysis of local field potentials and unit discharges in cat cerebral cortex during natural wake and sleep states. *J Neurosci* 19:4595–4608
- Destexhe A, Hughes SW, Rudolph M, Crunelli V (2007) Are corticothalamic ‘up’ states fragments of wakefulness? *Trends Neurosci* 30:334–342
- El Boustani S, Pospischil M, Rudolph-Lilith M, Destexhe A (2007) Activated cortical states: experiments, analyses and models. *J Physiol Paris* 101:99–109
- Gloor P, Fariello RG (1988) Generalized epilepsy: some of its cellular mechanisms differ from those of focal epilepsy. *Trends Neurosci* 11:63–68
- Golomb D, Wang XJ, Rinzel J (1996) Propagation of spindle waves in a thalamic slice model. *J Neurophysiol* 75:750–769
- Golshani P, Liu XB, Jones EG (2001) Differences in quantal amplitude reflect *glur4*-subunit number at corticothalamic synapses on two populations of thalamic neurons. *Proc Natl Acad Sci USA* 98:4172–4177
- Hodgkin AL, Huxley AF (1952) A quantitative description of membrane current and its application to conduction and excitation in nerve. *J Physiol* 117:500–544
- Hughes SW, Cope DW, Blethyn KL, Crunelli V (2002) Cellular mechanisms of the slow (<1 Hz) oscillation in thalamocortical neurons *in vitro*. *Neuron* 33:947–958
- Huntsman MM, Porcello DM, Homanics GE, DeLorey TM, Huguenard JR (1999) Reciprocal inhibitory connections and network synchrony in the mammalian thalamus. *Science* 283:541–543
- Jahnsen H, Llinás RR (1984) Electrophysiological properties of guinea-pig thalamic neurons: an *in vitro* study. *J Physiol Lond* 349:205–226
- Kim U, Bal T, McCormick DA (1995) Spindle waves are propagating synchronized oscillations in the ferret *Ignd* *in vitro*. *J Neurophysiol* 74:1301–1323
- Kumar A, Schrader S, Aertsen A, Rotter S (2008) The high-conductance state of cortical networks. *Neural Comput* 20:1–43
- Lüthi A, McCormick DA (1998) Periodicity of thalamic synchronized oscillations: the role of Ca^{2+} -mediated upregulation of I_h . *Neuron* 20:553–563

- McCormick DA (1992) Neurotransmitter actions in the thalamus and cerebral cortex and their role in neuromodulation of thalamocortical activity. *Prog Neurobiol* 39:337–388
- Peyrache A, Khamassi M, Benchenane K, Wiener SI, Battaglia FP (2009) Replay of rule-learning related neural patterns in the prefrontal cortex during sleep. *Nat Neurosci* 12:919–926
- Ribeiro S, Gervasoni D, Soares ES, Zhou Y, Lin SC, Pantoja J, Lavine M, Nicolelis MAL (2004) Long-lasting novelty-induced neuronal reverberation during slow-wave sleep in multiple fore-brain areas. *PLoS Biol* 2:126–137
- Rudolph M, Pelletier JG, Paré D, Destexhe A (2005) Characterization of synaptic conductances and integrative properties during electrically-induced EEG-activated states in neocortical neurons *in vivo*. *J Neurophysiol* 94:2805–2821
- Rudolph M, Pospischil M, Timofeev I, Destexhe A (2007) Inhibition determines membrane potential dynamics and controls action potential generation in awake and sleeping cat cortex. *J Neurosci* 27:5280–5290
- Sanchez-Vives MV, McCormick DA (2000) Cellular and network mechanisms of rhythmic recurrent activity in neocortex. *Nat Neurosci* 3:1027–1034
- Scheibel ME, Scheibel AB (1966) Patterns of organization in specific and nonspecific thalamic fields. In: DA P, M Y (eds) *The thalamus*. Columbia University Press, New York, pp 13–46
- Scheibel ME, Scheibel AB (1967) Structural organization of nonspecific thalamic nuclei and their projection toward cortex. *Brain Res* 6:60–94
- Sirota A, Csicsvari J, Buhl D, Buzsáki G (2003) Communication between neocortex and hippocampus during sleep in rodents. *Proc Natl Acad Sci USA* 100:2065–2069
- Steriade M (2003) *Neuronal substrates of sleep and epilepsy*. Cambridge University Press, Cambridge
- Steriade M (2001) Impact of network activities on neuronal properties in corticothalamic systems. *J Neurophysiol* 86:1–39
- Steriade M, Deschênes M (1984) The thalamus as a neuronal oscillator. *Brain Res* 8:1–63
- Steriade M, Contreras D, Curró Dossi R, Nunez A (1993a) The slow (<1 Hz) oscillation in reticular thalamus and thalamocortical neurons. Scenario of sleep rhythms generation in interacting thalamic and neocortical networks. *J Neurosci* 13:3284–3299
- Steriade M, McCormick DA, Sejnowski TJ (1993b) Thalamocortical oscillations in the sleeping and aroused brain. *Science* 262:697–685
- Steriade M, Nunez A, Amzica F (1993c) Intracellular analysis of relations between the slow (<1 Hz) neocortical oscillation and other sleep rhythms of the electroencephalogram. *J Neurosci* 13:3266–3282
- Steriade M, Nunez A, Amzica F (1993d) A novel slow (<1 Hz) oscillation of neocortical neurons *in vivo*: depolarizing and hyperpolarizing components. *J Neurosci* 13:3252–3265
- Steriade M, Jones EG, McCormick DA (1997) *Thalamus*. Elsevier, Amsterdam
- Steriade M, Timofeev I, Grenier F (2001) Natural waking and sleep states: a view from inside neocortical neurons. *J Neurophysiol* 85:1969–1985
- Timofeev I, Grenier F, Bazhenov M, Sejnowski TJ, Steriade M (2000) Origin of slow cortical oscillations in deafferented cortical slabs. *Cereb Cortex* 10:1185–1199
- Timofeev I, Grenier F, Steriade M (2001) Disfacilitation and active inhibition in the neocortex during the natural sleepwake cycle: an intracellular study. *Proc Natl Acad Sci USA* 98:1924–1929
- Vogels TP, Rajan K, Abbott LF (2005) Neural network dynamics. *Annu Rev Neurosci* 28:357–376
- von Krosigk M, Bal T, McCormick DA (1993) Cellular mechanisms of a synchronized oscillation in the thalamus. *Science* 261:361–364
- Wang XJ, Rinzal J (1993) Spindle rhythmicity in the reticularis thalami nucleus - synchronization among inhibitory neurons. *Neuroscience* 53:899–904
- Wang XJ, Golomb D, Rinzal J (1995) Emergent spindle oscillations and intermittent burst firing in a thalamic model: specific neuronal mechanisms. *Proc Natl Acad Sci USA* 92:5577–5581

Chapter 5

A Population Network Model of Neuronal and Neurotransmitter Interactions Regulating Sleep–Wake Behavior in Rodent Species

C.G. Diniz Behn and V. Booth

5.1 Introduction

Although the reasons for sleep remain unknown, sleep appears to be a universal necessity across mammals. All terrestrial mammalian species studied so far have exhibited not only sleep but also classical characteristics for both rapid eye movement (REM) sleep and non-REM (NREM) sleep (Siegel 2005; Zepelin et al. 2005), and common dynamical features of sleep–wake behavior appear to be conserved across species (Lo et al. 2004). However, there is much inter-specific variability in the timing and fine architecture of sleep–wake behavior. Most strikingly, this variability is reflected by the contrast between the consolidated sleep of some primates (Wexler and Moore-Ede 1985), including humans, and the polyphasic sleep–wake behavior common among many other species. Variability is also present in the distribution of sleep–wake behavior over the 24-hour day. Typically, a given species will be predominantly active during the day (diurnal) or night (nocturnal), but other 24-hour patterns of behavior, such as the concentration of activity at dawn and dusk (crepuscular activity), have also been reported (Sterman et al. 1965). This circadian modulation of sleep–wake behavior is a robust feature of terrestrial mammalian sleep.

Mammalian sleep and wake states are controlled by the activation of brainstem and hypothalamic neuronal nuclei (Steriade and McCarley 1990; Saper et al. 2001; Lydic and Baghdoyan 2005). Excitatory and inhibitory projections among these neuronal populations form a sleep–wake regulatory network. Both local effects within the sleep–wake regulatory network and more global effects on higher thalamo-cortical regions are driven by state-dependent activity within these populations and

V. Booth (✉)

Department of Mathematics and Department of Anesthesiology, University of Michigan,
Ann Arbor, MI 48109, USA

e-mail: vbooth@umich.edu

the resulting state-dependent release of their associated neurotransmitters (Saper et al. 2005). Many of the key structures involved in sleep–wake regulation are conserved across species. This suggests that perturbations of a single network structure can produce the reported variability in inter-specific sleep–wake behavior.

The identification of sleep–wake regulatory nuclei, their efferents/afferents, and the postsynaptic effects of their expressed neurotransmitters has resulted in the proposal of a number of conceptual models of network architectures governing sleep–wake behavior. However, such static conceptual models lack the ability to replicate the time dynamics of transitions between sleep–wake states or evaluate dynamic neuronal interactions that are dictated by network structure. In contrast, mathematical models of sleep–wake regulatory networks capture all time-dependent aspects of sleep–wake patterning. In recent years, several mathematical models of the sleep–wake regulatory network have been proposed. These models have primarily focused on rodent (Tamakawa et al. 2006; Diniz Behn et al. 2007) and human sleep (Tamakawa et al. 2006; Phillips and Robinson 2007; Rempé et al. 2010), and they illustrate how sleep–wake dynamics are generated by and consistent with network architecture.

We recently introduced a dynamic, mathematical model of a rat sleep–wake regulatory network using a novel modeling formalism that describes both the activity levels of each neuronal population and the release of their associated neurotransmitters in postsynaptic targets (Diniz Behn and Booth 2010). Using a specific architecture of interactions among neuronal nuclei, this model network captures dynamical patterns of state-dependent neuronal activity and state-dependent concentrations of key neurotransmitters to produce patterns of wake, NREM sleep, and REM sleep consistent with experimentally reported rat sleep–wake behavior in the light period. By explicitly modeling the dynamics of neurotransmitter release at the level of the neuronal population, this formalism provides the flexibility that is necessary to capture the complexity of the system.

Circadian variation in mammalian sleep–wake patterning is presumed to occur through modulation of the sleep–wake regulatory nuclei by the circadian pacemaker in the suprachiasmatic nucleus (SCN) (Saper et al. 2005). Both direct and indirect projections from SCN to sleep–wake regulatory nuclei contribute to this modulatory effect, and these projections are largely conserved across species (Stephan et al. 1981; Dai et al. 1997; Abrahamson et al. 2001; Kriegsfeld et al. 2004; Deurveilher and Semba 2005). The fine architecture of sleep–wake behavior varies significantly over 24 hours. These variations represent a constraint on underlying network structures: by simulating circadian changes in network interactions, a model network should accurately replicate differential light and dark period sleep–wake patterning.

Similarly, since experimental evidence suggests that sleep–wake regulatory mechanisms are conserved across species, the ability of a given architecture to generate sleep–wake patterning associated with multiple species represents an important constraint on the proposed network structure. In earlier work, Tamakawa and colleagues showed that, with minor variations in parameters, their network structure could produce sleep–wake patterning that was qualitatively similar to both rat and

human sleep (Tamakawa et al. 2006). To test the robustness of our model network structure, we are interested in whether the structure we used to simulate rat sleep could generate sleep–wake patterning associated with other species. Here, we investigate the ability of this network architecture to produce mouse sleep. Despite qualitative similarities, careful consideration of the fine architecture of sleep–wake behavior reveals significant variability within rodent sleep (van Twyver 1969; Franken et al. 1999). For example, the number of bouts of wake and NREM sleep in 12-hr light and dark periods were very similar for rats, but the number of NREM bouts was greater than the number of wake bouts in mice (Blanco-Centurion et al. 2007; Hu et al. 2007). These data highlight a structure difference between rat and mouse sleep: mice often transition from REM sleep directly back to NREM sleep while rats typically transition from REM sleep to wakefulness, at least briefly, before entering NREM sleep again.

Using the network structure developed to produce rat sleep in the light period, we identified key parameters associated with circadian modulation and varied these parameters to assess their effect on sleep–wake behavior. In addition, we identified parameters that could be modified to produce mouse sleep–wake behavior in both the light and dark periods. By keeping the network structure, including the sites of action of circadian effects, fixed between species, we identified both the flexibility and the limitations of the prescribed network structure. Our analysis of model behavior illustrates how specific components of network architecture dictate dynamic interactions influencing maintenance of states and transitions between states, and it provides insights into mechanisms through which the network can generate the range of sleep–wake patterning observed with circadian variation and across mammalian species.

5.2 Model

5.2.1 Population Firing Rate Model Formalism

We developed a model of the rat sleep–wake regulatory network (Fig. 5.1) using our novel firing rate model formalism for the interaction of neuronal populations and the neurotransmitters they express (Diniz Behn and Booth 2010). The network includes the wake-promoting, sleep-promoting, and REM sleep-promoting neuronal populations and their associated neurotransmitters summarized in Table 5.1.

Neurotransmitter-mediated coupling between populations includes inhibition from the monoaminergic wake-promoting populations, LC and DR, to both the sleep-promoting VLPO and the REM active subpopulation of the LDT/PPT (R), but not the wake/REM active LDT/PPT subpopulation (WR) (Thakkar et al. 1998). The sleep-promoting VLPO inhibits all wake-promoting and REM-promoting populations and cholinergic REM- and wake/REM active populations excite the LC and DR. Specific subcomponents of this coupling structure reflect current conceptual models of the sleep–wake regulatory network. Specifically, mutual inhi-

Table 5.1 Summary of key neuronal nuclei and associated neurotransmitters involved in sleep-wake regulation

	Population	Neurotransmitter
Wake-promoting	Dorsal raphe (DR)	Serotonin (5-HT)
	Locus coeruleus (LC)	Noradrenaline (NE)
	wake/REM active subpopulations of laterodorsal tegmental nucleus and pedunculopontine tegmental nucleus (LDT/PPT)	Acetylcholine (ACh)
Sleep-promoting	Ventrolateral preoptic area (VLPO)	GABA
REM-promoting	REM active subpopulation of LDT/PPT	Acetylcholine (ACh)

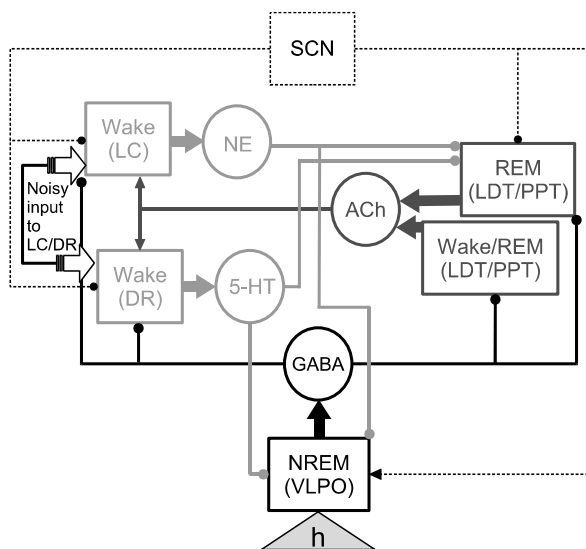

Fig. 5.1 Schematic of rat sleep-wake regulatory network model containing the neuronal populations and their associated neurotransmitters listed in Table 5.1, and the effects of direct and indirect synaptic projections from the suprachiasmatic nucleus (SCN). **Bold arrows** indicate neurotransmitter expression, **circles (small arrows)** indicate inhibitory (excitatory) postsynaptic action of neurotransmitters. Model also includes a homeostatic sleep drive (**triangle**) and random, excitatory inputs to wake-promoting populations (**white arrows**)

bition between the LC and DR, and the VLPO provides the basis for the sleep-wake flip-flop switch (Saper et al. 2001), and reciprocal connectivity between LC and DR, and REM-promoting populations (LDT/PPT) reflects the reciprocal-interaction hypothesis for NREM-REM cycling (McCarley and Hobson 1975; Massaquoi and McCarley 1992).

In our firing rate model formalism, we retain the basic form of standard firing rate models (Wilson and Cowan 1972; see reviews in Ermentrout 1998; Dayan and Abbott 2001; Deco et al. 2008), but we replace total synaptic input with a weighted sum of neurotransmitter concentrations released by presynaptic populations, $C_i(t)$. In this way, firing rate in the postsynaptic population X , $F_X(t)$ (in Hz, $X = LC, DR, VLPO, R$ or WR), is modeled by the standard equation of the following form:

$$F'_X = \frac{F_{X\infty}(\sum_i g_{i,X} C_i) - F_X}{\tau_X}, \quad (5.1)$$

where $F_{X\infty}(\cdot)$ is the steady-state firing rate function, the $g_{i,X}$ are constant weights, and τ_X is the time constant associated with the response of the postsynaptic population. For the steady-state firing rate function, we use the standard sigmoidal function

$$F_{X\infty}(c) = X_{\max}(0.5(1 + \tanh((c - \beta_X)/\alpha_X))), \quad (5.2)$$

where the parameter X_{\max} sets the maximal firing rate and the parameters α_X , and β_X set slope and activation threshold properties, respectively (Fig. 5.2A). Interactions between populations are reflected in the terms included in the argument $\sum_i g_{i,X} C_i$ of the steady-state firing rate functions $F_{X\infty}(\cdot)$ for each population. Additionally, random amplitude, excitatory pulses, arriving according to a Poisson process, were included in the arguments of the LC and DR steady-state activation functions to simulate activity of top-down excitatory projections from thalamocortical circuits (Arnsten and Goldman-Rakic 1984; Jodo et al. 1998).

Neurotransmitter concentration, $C_i(t)$, depends on the firing rate of the presynaptic population, generically referred to as $F_Y(t)$ ($i = N$ (NE) for $Y = LC$; $i = S$ (5-HT) for $Y = DR$; $i = G$ (GABA) for $Y = VLPO$; $i = A(R)$ (ACh) for $Y = R$; and $i = A(WR)$ (ACh) for $Y = WR$). In our formalism, $C_i(t)$ evolves to a nonlinear function of $F_Y(t)$ as described by the following equation:

$$C'_i = \frac{C_{i\infty}(F_Y) - C_i}{\tau_i}, \quad (5.3)$$

where steady-state neurotransmitter release, $C_{i\infty}(\cdot)$, is a saturating function and τ_i is the associated time constant. Because different microdialysis techniques lead to differences in absolute reported neurotransmitter concentrations, we normalize each neurotransmitter concentration between 0 and 1. The functional form of $C_{i\infty}(f) = \tanh(f/\gamma_i)$, prescribes the relationship between presynaptic firing rate and neurotransmitter release, and the shape of this function was chosen to be consistent with experimental data (Aston-Jones and Bloom 1981; Lydic and Baghdoyan 1993) (Fig. 5.2B). The time scale described by τ_i reflects the time dynamics associated with neurotransmitter release at the level of the population rather than at an individual synapse.

Neurotransmitter release is correlated with the firing rate of the presynaptic population, and variability of release grows with concentration level (Aston-Jones and Bloom 1981). To incorporate variability of neurotransmitter release into the model, the steady-state neurotransmitter release function was multiplicatively scaled by a noise factor whose amplitude randomly varied (with normal distribution and unit

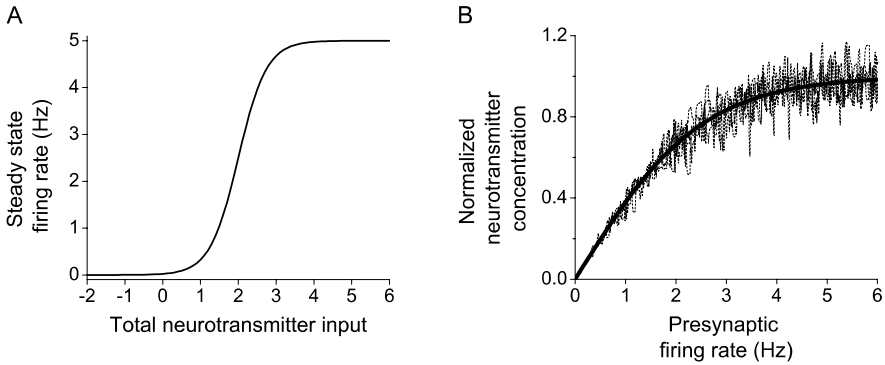

Fig. 5.2 Representative steady-state firing rate function (**A**) and neurotransmitter release function (**B**) showing deterministic values (*thick line*) and randomly varying values (*dashed lines*). Modified from Diniz Behn and Booth, *Journal of Neurophysiology*, 2010 (Am Physiol Soc, used with permission)

mean) according to a Poisson process with an average rate of 0.1 Hz. This mechanism introduced a time-varying element into steady-state neurotransmitter release and resulted in variable target neurotransmitter concentrations for fixed presynaptic firing rates (Fig. 5.2B).

Transitions between sustained bouts of wake and sleep are governed by a homeostatic sleep drive that describes the universally recognized propensity for increasing sleep need with time awake. The neuromodulator adenosine (reviewed in Basheer et al. 2004; Huang et al. 2007) is one mechanism involved in mediating homeostatic sleep drive. We modeled the sleep-promoting effects of adenosine through the variable h that increases toward 1 during wakefulness and decreases toward 0 during sleep states with time scales τ_{hw} and τ_{hs} , respectively. To incorporate this homeostatic sleep drive into the sleep–wake network model, we focused on the effects of adenosine on the VLPO (Chamberlin et al. 2003; Morairty et al. 2004; Gallopin et al. 2005) by including an h -dependence in the activation threshold of the VLPO population (compare to (5.2)):

$$F_{VLPO\infty}(c) = VLPO_{\max}(0.5(1 + \tanh((c - \beta_{VLPO}(h))/\alpha_{VLPO}))), \quad (5.4)$$

where $\beta_{VLPO}(h) = -kh$ with the parameter k relating the value of h to the VLPO activation threshold.

Parameter values in the model were based on experimental data when possible, inferred from related experimental data when plausible or optimized to replicate the fine architecture of rat sleep–wake patterning. The full equations are given in Diniz Behn and Booth (2010). All parameter values are the same as in Diniz Behn and Booth (2010) except for the following: $g_{G,LC} = g_{G,DR} = 2.7$, $g_{A,R} = 1.5$, $g_{N,R} = g_{S,R} = 3.8$, $g_{G,WR} = 1.5$, $\beta_{LC} = \beta_{DR} = -0.3$, $\beta_{WR} = -0.15$, $\alpha_{WR} = 0.5$ and $k = -4$. The following parameters were modified to obtain sleep–wake patterning for the rat and the mouse: $g_{A,LC} = g_{A,DR} = 3$ (rat), 4 (mouse); $g_{G,R} = 1.1$ (rat), 1 (mouse); $g_{A,WR} = 0.6$ (rat), 0.7 (mouse); $\tau_{A,R} = \tau_{A,WR} = 50s$ (rat), 40 s (mouse);

$\alpha_R = 0.28$ (rat), 0.4 (mouse); $\beta_R = -0.66$ (rat), -0.65 (mouse); $\tau_{hw} = 700$ s (rat), 300 s (mouse); $\tau_{hs} = 250$ s (rat), 200 s (mouse). Additionally, the random excitatory pulses to the LC and DR had mean amplitude of 10 and standard deviation of 0.1 for both the rat and mouse, and occurred according to a Poisson process with average rate of 0.003 Hz (rat), 0.004 Hz (mouse). The pulses instantaneously activated and decayed exponentially with a time constant of 10 s (rat), 20 s (mouse). The model equations were numerically simulated using a modified Euler method with time step 0.005 s implemented with the software XPPAUT, developed by G.B. Ermentrout.¹

In simulations of the model network, states of wake, NREM sleep, and REM sleep were interpreted based on firing rates of neuronal populations and concentration levels of their associated neurotransmitters (see Fig. 5.3). For example, wake was defined by activation of the wake-promoting populations (firing rates F_{LC} , F_{DR} and F_{WR}) and high expression of NE, 5-HT and ACh (concentration levels C_N , C_S and $C_A(WR)$, respectively); NREM sleep was defined by activation of the VLPO (firing rate F_{VLPO}) and inactivation of wake-promoting populations, resulting in high GABA expression (concentration level C_G) and diminished monoamine and cholinergic expression; and REM sleep was associated with high F_{VLPO} levels and activation of the REM-promoting population (firing rate F_R) with its contribution to ACh expression (concentration level $C_{A(R)}$).

5.2.2 *Suprachiasmatic Nucleus Projections to Sleep–Wake Centers*

Direct projections from the SCN to the populations of the sleep–wake regulatory network are sparse, but there are strong indirect projections that mediate circadian regulation of sleep–wake behavior. The primary pathway projects from the SCN to the ventral subparaventricular zone (sPVZ) and then to the dorsomedial hypothalamus (DMH) (Saper et al. 2005). The primary neurotransmitter expressed by SCN synapses as well as synapses of sPVZ and DMH neurons is GABA, thus the indirect projection pathway consists of sequential inhibitory projections. The DMH excites neurons in the lateral hypothalamus which project to the wake-promoting populations LC and DR and to REM-promoting populations in the LDT and PPT (Horvath et al. 1999; Burlet et al. 2002; Chou et al. 2003; Espana et al. 2004). The sleep-promoting population VLPO receives projections from both the sPVZ and the DMH, in addition to sparse direct projections from the SCN that appear to be both GABAergic (inhibitory) and glutamatergic (excitatory) (Sun et al. 2001). Since the activity rhythm in the SCN is similarly phased for diurnal and nocturnal animals, inversion of SCN circadian signaling in nocturnal rodents is presumed to occur downstream from the SCN, with the sPVZ being a likely candidate (Mistlberger 2005). For simplicity, we do not include the intermediary populations or their neurotransmitters in the current extension of our network model. Instead, we introduce projections from the SCN that simulate the net effects

¹Available at <ftp://ftp.math.pitt.edu/pub/bardware>.

of these direct and indirect projections to the sleep–wake populations. Specifically, direct and indirect projections result in net excitatory effects of the SCN on the VLPO, and indirect projections result in net inhibitory effects of the SCN on LC, DR, LDT, and PPT, see Fig. 5.1.

The 24-hour period of the circadian pacemaker varies slowly compared to the time scales of rodent sleep–wake behavior. Therefore, we modeled SCN activity as a fixed parameter, F_{SCN} . For each sleep–wake population receiving indirect SCN input, F_{SCN} was appropriately weighted by the parameters $g_{SCN,X}$ (for $X = LC, DR, R,$ and $VLPO$), and the resulting terms were added to the arguments of the associated steady-state firing rate function. The weighting parameters are summarized in following table:

	g_{SCN}	$g_{SCN,DR}$	$g_{SCN,VLPO}$	$g_{SCN,R}$
Rat	1.8	1.8	1.4	0.33
Mouse	1.75	1.75	1.4	0.4

The parameter F_{SCN} was switched from a low value during the dark period ($F_{SCN} = 0.15$ (rat), 0.2 (mouse)) to a high value during the light period ($F_{SCN} = 0.73$ for both rat and mouse) to represent the general trend in firing rates of SCN neurons (Schwartz et al. 1983; Gillette and Reppert 1987; Deboer et al. 2003). The F_{SCN} and $g_{SCN,X}$ values for the rat and mouse differ slightly so as to obtain optimal agreement with experimental measurements of the fine architecture of sleep–wake patterning. In addition, for the mouse, the average frequency of the random excitatory pulses to LC and DR was increased from 0.004 to 0.007 Hz during the dark period to represent an increase in top-down sensory input during the animal’s active period that acts to fragment NREM sleep more significantly in the mouse compared to the rat (see below).

5.3 Results

5.3.1 Rat Sleep–Wake Patterns in Dark and Light Periods

Within this firing rate model formalism, neuronal firing activity is positively correlated with the strength of resulting neurotransmitter action on the postsynaptic population. Thus, when SCN activity is low during the dark period, the action of the simulated direct and indirect SCN afferents to the sleep–wake centers is minimized. In this parameter regime, simulated sleep and wake patterning matched that experimentally observed in the rat, including features such as consolidated wake bouts, fragmented NREM bouts, and bidirectional transitions between both wake and NREM sleep and between NREM and REM sleep (Fig. 5.3A). Consistent with experimental observations, many REM bouts were immediately followed by transitions to wake (Weitzman et al. 1980). In addition to these similarities in the structure of sleep–wake behavior, standard measures of wake, NREM sleep, and REM

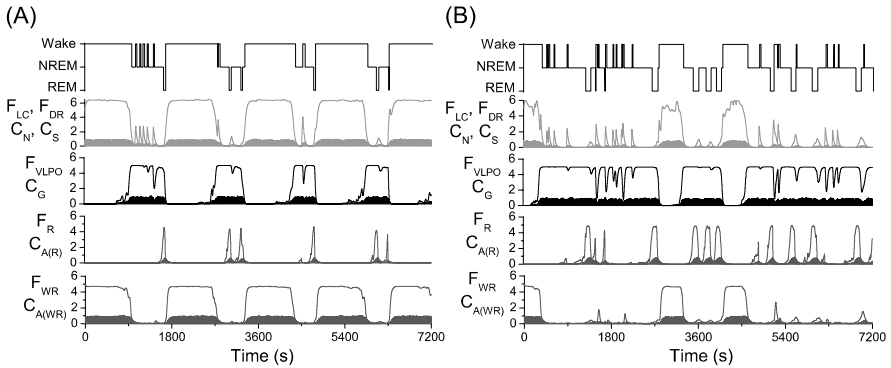

Fig. 5.3 Model simulations of rat sleep–wake behavior in the dark period (A) and the light period (B). Hypnogram (top trace), population firing rates (curves in second to fifth traces) and neurotransmitter concentration levels (shaded regions in second to fifth traces) in wake-promoting populations LC and DR (F_{LC} , F_{DR} and C_N , C_S , 2nd trace, light gray), NREM-promoting population VLPO (F_{VLPO} and C_G , third trace, black), REM-promoting population (F_R and $C_{A(R)}$, fourth trace, dark gray) and wake/REM-promoting population (F_{WR} and $C_{A(WR)}$, fifth trace, dark gray). State-dependent firing rates in the second to fifth traces determine the sleep–wake state recorded in the hypnogram

sleep were similar between simulations and experimental reports of baseline sleep–wake behavior for adult male Sprague Dawley rats during the dark period (Blanco-Centurion et al. 2007). These measures included total percentages of time in wake, NREM sleep, and REM sleep, mean bout durations, and numbers of bouts across 12 hours, cf. Fig. 5.4 (dark unhatched bars).

In the dark period parameter regime, model dynamics are dominated by a NREM sleep-REM sleep–wake cycling pattern. As described in Diniz Behn and Booth (2010), when the noisy components of the model (variability of the neurotransmitter release functions and random excitatory inputs to the LC and DR) are removed, this cycle is a stable, periodic solution of the model that is inherent to the network structure. On a qualitative level, we can understand how the network structure dictates this cycling pattern by considering the action of the homeostatic sleep drive on VLPO activation. In particular, this analysis clarifies the mechanisms that govern the occurrence of REM sleep and allow REM activation exclusively from the NREM state.

During wakefulness, the homeostatic sleep drive variable h increases, thereby causing a decrease in the activation threshold of the VLPO steady-state activation function as described in (5.4). As h increases, this change in activation threshold eventually causes VLPO to activate, and the resulting expressed GABA inhibits LC and DR to eventually suppress their activity and drive a transition to NREM sleep. During NREM sleep, h decreases in a manner consistent with dissipation of homeostatic sleep drive. As h decreases, the VLPO activation threshold increases until VLPO can no longer maintain activation, and LC and DR are released from GABA-mediated inhibition. This allows LC and DR to activate, thereby driving a transition to wake.

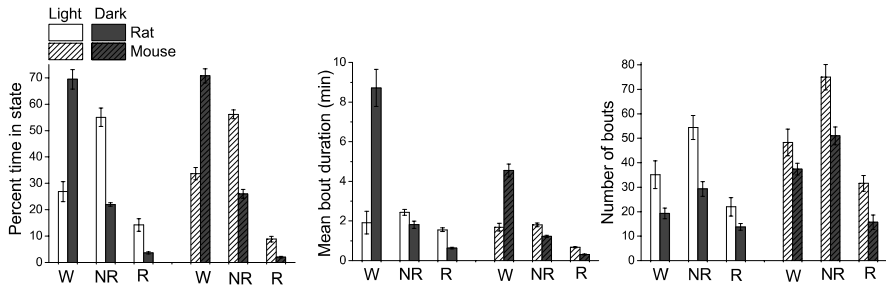

Fig. 5.4 Simulated rat (*unhatched bars*) and mouse (*hatched bars*) sleep–wake behavior captures inter-specific differences. The following standard measures for wake (W), NREM sleep (NR) and REM sleep (R) during the light period (*white bars*) and the dark period (*dark gray bars*) are reported: percent time spent in each state (**A**); mean bout duration (**B**); and mean number of bouts over 12 hours (**C**). Means and standard deviations of model results determined from 10 simulation runs

To understand the timing of REM sleep within this cycle, we consider the network effects on the REM-promoting population during each of these transitions. Since the REM-promoting population receives both monoaminergic inhibition from LC and DR, and GABAergic inhibition from VLPO, the REM-promoting population is maximally inhibited and least likely to activate at the wake-to-NREM sleep transition when VLPO, LC, and DR are all active. By contrast, at the NREM sleep-to-wake transition, the REM-promoting population is minimally inhibited since monoaminergic inhibition is absent, and GABAergic inhibition decreases with VLPO inactivation. Thus, the differences in net inhibitory input to the REM-promoting population at these two state transitions prevent REM activation at the wake-to-NREM sleep transition but promote it at the NREM sleep-to-wake transition, consistent with experimentally observed patterns of REM sleep (Dijk and Kronauer 1999; Carskadon and Dement 2000; Mochizuki et al. 2004).

SCN activity is higher in the light period, and we simulated this difference by increasing the model parameter F_{SCN} , representing the firing rate of the SCN, from the dark period value of $F_{SCN} = 0.15$ to the light period value of $F_{SCN} = 0.73$. The resulting coherent increase in the strength of SCN-mediated inhibition and excitation of sleep–wake regulatory populations resulted in significant changes in simulated sleep and wake patterning: extended wake bouts were shorter, and NREM bouts were longer and more consolidated, though brief wake bouts and REM bouts continued to fragment NREM sleep. Additionally, REM bouts were longer and occurred more often (Fig. 5.3B). Standard measures of the fine architecture of sleep–wake behavior, including total percentages of time in wake, NREM sleep, and REM sleep, mean bout durations, and numbers of bouts across 12 hours agree well with experimental measurements for adult male Sprague Dawley rats during the light period (Blanco-Centurion et al. 2007), see Fig. 5.4 (white unhatched bars). We emphasize that these experimentally consistent light and dark period associated changes in state patterning are obtained by varying the single parameter, F_{SCN} . Properties of the homeostatic sleep drive, population activation, and neurotransmitter release, as

well as all time constants governing population and neurotransmitter dynamics, are identical in the simulated light and dark periods.

The increase in F_{SCN} augmented both inhibitory input to LC, DR and the REM-promoting population and excitatory input to the VLPO. We can understand how SCN projections modulate network patterning by considering their effect on the homeostatically driven alternation between NREM sleep and wake. Projections from the SCN to both wake- and NREM sleep-promoting populations all contributed to decreasing wake bout durations. The SCN excitatory input to the VLPO decreases the net inhibition level the VLPO receives during the wake state. Thus, the homeostatically controlled VLPO activation threshold does not need to decrease as much, or, equivalently, the homeostatic sleep drive h does not need to increase as much, to drive VLPO activation. Since VLPO activation terminates wake bouts, this change results in shorter wake bouts. In addition, SCN inhibitory input to LC and DR increases the net inhibition level to the LC and DR. Thus, in the presence of strong SCN activity, less GABAergic inhibition from the VLPO is necessary to suppress LC or DR activation, so this mechanism also contributes to decreasing wake bout durations.

Interestingly, effects of SCN inhibitory input to the LC and DR propagate through the network to affect both NREM and REM bout durations. NREM bout durations are decreased since the SCN inhibitory projection to LC and DR shortens wake bouts which, in turn, shorten the period of the homeostatically controlled alternation between wake and NREM sleep by decreasing the time necessary to return the homeostatically controlled VLPO activation threshold to values that inactivate the VLPO. On the other hand, this projection acts to lengthen REM bout durations. In the reciprocal-interaction structure of the network, a REM bout is terminated by monoaminergic inhibition from the LC and DR. Therefore, increased SCN inhibitory input to the LC and DR translates to an increase in the levels of cholinergic excitation (from the REM-promoting and wake-REM-promoting populations) needed for LC and DR activation. Thus, the REM-promoting population is able to maintain activation for a longer period of time before it is inactivated by monoaminergic inhibition.

The question remains, then, what role the effects of the SCN inhibitory projection to the REM-promoting population play. Increased inhibitory input to the REM-promoting population has very limited impact on REM bout duration. However, this inhibition delays the activation of the REM-promoting population during NREM sleep, thereby increasing NREM bout durations. Hence, SCN inhibitory input to the LC and DR, and to the REM-promoting population have competing effects on NREM bout durations which may contribute to the general maintenance of mean NREM bout durations across the light and dark periods in contrast to the more significant changes observed in wake and REM bout durations (Blanco-Centurion et al. 2007).

For high levels of F_{SCN} , when SCN projections to the sleep-wake populations are strong as occurs in our light period simulations (see Fig. 5.3B), the excitatory input to the VLPO and the inhibitory input to the LC and DR can override the homeostatically controlled alternations between wake and NREM sleep, forcing sustained

VLPO activation. Transitions from NREM sleep to an extended wake bout can occur in this parameter regime due to the noisy components of the model, but their occurrence is irregular and sporadic. The duration of these extended wake bouts is controlled by the homeostatic sleep drive variable h and is generally short due to the effects of the SCN projections on the homeostatically driven cycle as described above.

Although most of the sustained VLPO activation translates to NREM sleep, the NREM sleep state is fragmented by the occurrence of brief wake bouts, driven by the random excitatory inputs to LC and DR, and of REM bouts governed by the reciprocal-interaction oscillations between the REM-promoting population and wake-promoting LC and DR. These oscillations, similar to those in the original reciprocal-interaction model for NREM-REM cycling (McCarley and Hobson 1975; Massaquoi and McCarley 1992), occur through activation of the REM-promoting population that provides cholinergic excitation to LC and DR, which, in turn, produce monoaminergic inhibition that terminates REM activation. In our model parameter set, the substantial SCN inhibitory input to LC and DR results in minimal LC and DR activation in response to REM sleep-related cholinergic excitation. In many instances, these minor activations do not trigger a wake bout. Therefore, at the level of behavior, these interactions produce cycling between NREM sleep and REM sleep that can be regular and relatively fast; however, this cycling is generally interrupted by random, noise-induced brief wake bouts that delay REM activation.

5.3.2 Mouse Sleep–Wake Patterns in Light and Dark Periods

While there is variability within rat and mouse species, measurements of percentages of time spent in the states of wake and NREM sleep for both rat and mouse species in the light and dark periods do not differ greatly (Franken et al. 1999; Blanco-Centurion et al. 2007; Hu et al. 2007). Instead, major differences between rat and mouse sleep–wake patterning appear in the fine temporal architecture of sleep–wake behavior. These include an increase in fragmentation of wake and NREM bouts and a decrease in mean REM bout durations in the mouse compared to the rat (Blanco-Centurion et al. 2007; Hu et al. 2007). We modified a limited number of parameters in our model network from their values replicating rat sleep–wake patterning in the dark period to obtain patterning that agreed well with standard measures of sleep–wake patterning in adult male C57BL/6J mice in the dark period (Hu et al. 2007), cf. Fig. 5.5A and Fig. 5.4 (dark hatched bars). Additionally, and more importantly, by increasing our SCN activity variable F_{SCN} by roughly the same amount that accounted for the differences in rat sleep–wake patterning in the light and dark periods, our model network replicated the differences in mouse sleep–wake patterning in the light and dark periods (Hu et al. 2007) (Fig. 5.5B and Fig. 5.4, hatched bars).

To obtain appropriate sleep–wake patterning for the mouse in the dark period, we adjusted parameters to affect wake and NREM bout consolidation by decreasing the time constants governing the increase and decrease of the homeostatic sleep drive variable h ($\tau_{hw} = 300$ s, $\tau_{hs} = 200$ s). For the mouse, then,

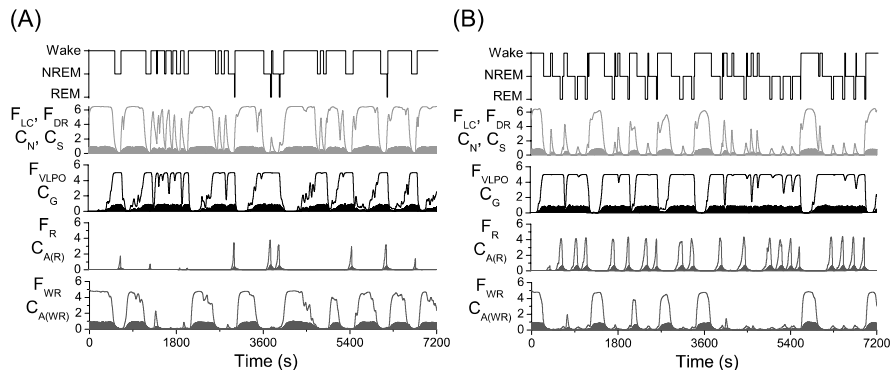

Fig. 5.5 Model simulations of mouse sleep–wake behavior in the dark period (A) and the light period (B). Hypnogram (top trace), population firing rates (curves in second to fifth traces) and neurotransmitter concentration levels (shaded regions in second to fifth traces) in wake-promoting populations LC and DR (F_{LC} , F_{DR} and C_N , C_S , second trace, light gray), NREM-promoting population VLPO (F_{VLPO} and C_G , third trace, black), REM-promoting population (F_R and $C_{A(R)}$, fourth trace, dark gray) and wake/REM-promoting population (F_{WR} and $C_{A(WR)}$, fifth trace, dark gray). State-dependent firing rates in the second to fifth traces determine the sleep–wake state recorded in the hypnogram

the homeostatic sleep drive increased more quickly during wake states, causing earlier transitions to NREM sleep, and then dissipated slightly faster during NREM sleep, providing a higher frequency of the homeostatically driven alternations of wake and NREM sleep. To further promote increased fragmentation of NREM bouts in the dark period, we altered random excitatory inputs to LC and DR by increasing their frequency and amplitude as well as the time constant governing their decay. To obtain the significantly shorter mean REM bout durations measured in the mouse compared to the rat (Blanco-Centurion et al. 2007; Hu et al. 2007), we adjusted several parameters that control cholinergic expression of the REM- and wake-REM-promoting populations and the response of the LC and DR to cholinergic excitation. Specifically, to promote faster LC and DR response to the release of ACh, we increased the weighting factors $g_{A,LC}$ and $g_{A,DR}$ ($g_{A,LC} = g_{A,DR} = 4$); to promote faster activation of the wake-REM-promoting population and thus increase the rate of ACh release, we increased the weighting factor $g_{A,WR}$ ($g_{A,WR} = 0.7$); and to increase the rate of ACh expression, we decreased the time constant governing ACh expression $\tau_{A,R}$ and $\tau_{A,WR}$ ($\tau_{A,R} = \tau_{A,WR} = 40$ s). To further limit REM bout durations, we adjusted parameters that control the level of activation of the REM-promoting population. In particular, we increased the parameter governing the slope of the steady-state activation function of the REM-promoting population to make the slope shallower ($\alpha_R = 0.4$) and slightly increased its activation threshold ($\beta_R = -0.65$).

Model dynamics for the mouse in the dark period are generally similar to the dynamics for the rat; there is a dominant, homeostatically driven cycling pattern from NREM sleep to REM sleep to wake. However, the parameter changes that promote shorter REM bout durations occasionally result in minimal REM-population acti-

vation at the NREM-to-wake transition (see Fig. 5.5A, fourth trace) so that a REM bout is not triggered and NREM sleep transitions directly to an extended wake bout.

When the SCN activity parameter F_{SCN} is increased to make SCN afferents to the sleep–wake populations strong, effects on model dynamics similar to those in the rat case described above are observed. There is a systematic decrease in wake bout durations due to increased inhibition to the LC and DR, and increased excitation to the VLPO. Network propagated effects of the increased inhibitory input to LC and DR increase REM bout durations. In addition, competing effects of SCN inhibitory input to the LC and DR, and to the REM-promoting population prevent significant changes in NREM bout durations. For simulations of mouse sleep–wake patterning in the light period (Fig. 5.5B), SCN activity levels are highest and suppress homeostatically driven alternations between NREM sleep and wake, similar to the case of the rat. For the mouse, noise-initiated extended wake bouts occur more frequently due to the parameter changes increasing LC and DR response described above, but are shorter in length due to changes in the time constants governing the homeostatic sleep drive. NREM-REM cycling occurs through reciprocal-interaction oscillations between the REM-promoting population, and LC and DR, but more often LC and DR activation terminating the REM bout triggers a brief wake bout. To promote consolidation of NREM bouts during the light period for the mouse, we decreased the frequency and amplitude of the random excitatory inputs to LC and DR back to levels similar to the rat.

5.4 Discussion

5.4.1 Summary of Results

The propagation of circadian signals from the SCN to sleep–wake regulatory centers involves myriad projection pathways, including multiple direct and indirect synaptic projections that target both sleep-promoting and wake-promoting populations, and paracrine signaling of diffusible molecules such as transforming growth factor- α and prokineticin-2 (Mistlberger 2005). However, the dynamic effects of individual pathways on activity of sleep–wake regulatory populations have not been determined. We have identified a parsimonious set of physiologically justified SCN synaptic projections to key wake-, and sleep-promoting populations such that coherent changes in activity on these projections alter the fine architecture of rodent sleep–wake patterning consistent with experimental measurements of circadian modulation of sleep–wake behavior.

By analyzing model solutions, we have identified how these SCN projections can shift the network into different dynamical regimes where sleep–wake patterning shows characteristics typically observed in the light or dark circadian phases. When the strength of these projections was low, consistent with low SCN firing rates observed during the dark period, model dynamics were dominated by homeostatically driven alternations of NREM sleep and extended wake states. NREM bouts were

fragmented by brief wakes and REM bouts occurred infrequently and with short duration. Increasing the strength of SCN projections, consistent with the higher SCN firing rates observed during the light period, caused a systematic decrease in the duration of extended wake bouts and an increase in REM bout durations. In addition, these strong projections shifted network dynamics to a regime in which NREM sleep bouts, though fragmented by brief wakes, were more consolidated; cycling between NREM and REM bouts occurred more regularly; and NREM sleep was interrupted irregularly and sporadically by relatively extended wake bouts. Model analysis also illuminated how an inhibitory SCN projection to REM-promoting regions in the LDT and PPT is not inconsistent with longer REM bout durations occurring when SCN activity is high. Our analysis showed that, in the proposed network structure, REM bout durations are more tightly regulated by monoaminergic inhibition from LC and DR, while inhibitory input from the SCN had a greater effect on the timing of REM bout initiation.

5.4.2 Network Structure Captures Salient Differences Between Rat and Mouse Sleep

Experimental evidence suggests that sleep–wake regulatory mechanisms are generally conserved across species. We propose that an important constraint on a hypothesized sleep–wake regulatory network structure is its ability to generate 24-hour sleep–wake patterning associated with multiple species. While sleep–wake patterning among rodent species does not differ as dramatically as across other mammalian species, there are several crucial differences in the fine architecture of rat and mouse sleep.

Some of these differences appear to be independent of the detailed network structure. For example, all dynamic sleep–wake regulatory mathematical models include a homeostatic sleep drive that regulates transitions of the mutually inhibitory “flip-flop” interactions between NREM- and wake-promoting populations (Tamakawa et al. 2006; Diniz Behn et al. 2007; Phillips and Robinson 2007; Rempé et al. 2010). As we have shown, changes in the time scales governing the homeostatic sleep drive can account for rat/mouse variations in wake and NREM bout durations in our network structure. However, since the homeostatic sleep drive plays a comparable role in regulating wake and NREM bout durations in other models, it is likely that wake and NREM bout durations will be subject to a similar dependence on the time scales of the growth and decay of the homeostatic sleep drive in other network structures. Such differences in time scales may be linked to inter-specific variation in metabolic rate (see below).

Other significant differences in the fine architecture of sleep–wake behavior are critically tied to network structure. One such difference is the short REM bout duration in the mouse compared to the rat. The network mechanisms responsible for the regulation for REM sleep are much debated, and a number of competing conceptual models have been proposed (Lu et al. 2006; Luppi et al. 2006; Brown et al. 2008;

Sapin et al. 2009). In the reciprocal-interaction-based network structure we consider, REM bout duration is affected by the response properties of LC and DR to cholinergic excitation from the REM-promoting population and the consequent response of the REM-promoting population to LC- and DR-mediated monoaminergic inhibition. The parameter modifications necessary to obtain appropriately decreased REM bout durations indicate possible sources of physiological differences between rat and mouse that can be experimentally probed (see below). Similarly, accounting for this difference in REM bout duration in competing models for REM regulation would suggest other targets for investigation of physiological differences between rat and mouse or identify important constraints on network structure.

Another fundamental difference in the fine architecture of rat and mouse sleep is the similarity in the number of bouts of wake and NREM sleep in 12-hr light and dark periods for rats, and the greater number of NREM bouts compared to wake bouts measured in mice (Blanco-Centurion et al. 2007; Hu et al. 2007). This difference indicates that mice often transition from REM sleep directly back to NREM sleep while rats typically transition from REM sleep to wakefulness, at least briefly, before entering NREM sleep again. A limitation of the reciprocal-interaction model for REM sleep regulation is that such a network structure cannot produce REM sleep without generating activity in LC and DR. In the parameter regimes presented here for the rat and mouse, LC and DR activation following a REM bout was often minimal and did not trigger a wake bout. While these dynamics resulted in appropriate differences in the numbers of NREM and wake bouts for the mouse simulations, the imbalance in bout numbers was also present in the rat simulations (see Fig. 5.4).

We have identified other parameter values that give appropriately balanced wake and NREM bouts for the rat in the light period (Diniz Behn and Booth 2010). However, we note that, in the reciprocal-interaction structure, increasing REM bout duration and reliably obtaining a wake bout following a REM bout can be competing mechanisms: increased REM bout durations result from weaker LC and DR activation, but weak LC and DR activation is not consistent with a post-REM sleep–wake bout. While further parameter optimization may result in parameter values that give the appropriate numbers of bouts for rat and mouse in the light and dark periods, the sensitivity of this aspect of the fine architecture of our model dynamics suggests a constraint on the proposed network structure.

A final species-dependent feature of the fine architecture of sleep–wake behavior pertains to the pattern of REM sleep. In particular, a conserved network structure should be able to produce REM bouts with either regular or variable timing. Although periodic REM bouts have not been reported in rats or mice, the regular alternation between NREM sleep and REM sleep has been well-characterized in many species including humans (McCarley and Hobson 1975; Carskadon and Dement 2000). These periodic oscillations were a driving consideration in the original dynamic implementation of the reciprocal-interaction hypothesis (McCarley and Hobson 1975; Massaquoi and McCarley 1992). With minor variations in parameters, a reciprocally connected network structure, such as ours, can produce both regular alternations in NREM and REM sleep and the more variable REM sleep bouts observed in rats and mice (Diniz Behn and Booth 2010). Such flexibility has not yet been demonstrated for other conceptual models of REM sleep regulation.

5.4.3 *Model Predictions*

The SCN projection pathways to sleep–wake regulatory populations that we have considered here represent a parsimonious reduction of the myriad synaptic and paracrine projections by which the SCN conveys circadian signaling to sleep–wake centers. The ability of these projections to regulate the fine architecture of sleep patterning in a manner consistent with experimentally measured circadian modulation reinforces their contributions in the physiological system. Thus, model results predict that net inhibitory inputs to wake-promoting and REM-promoting populations and net excitatory inputs to NREM sleep-promoting populations are key factors in the SCN projection pathway. Analysis of model results predicts that the inhibitory inputs to the wake-promoting populations have a direct effect on wake bout durations, but, interestingly, the inhibitory inputs to the REM-promoting population do not affect REM bout durations significantly. We simulated coherent activation on all projection pathways to obtain appropriate circadian modulation of sleep–wake patterning. Further analysis that investigates effects on patterning of dissociated activation of these pathways may provide specific predictions for experiments that target manipulations of individual projection pathways.

The parameter changes required to obtain the different patterning of sleep and wake states in the rat and the mouse within this network structure suggest physiological differences between the species that can be experimentally tested. For example, required changes to time constants governing the homeostatic sleep drive variable h suggest differences in the accumulation and dissipation of sleep need that may be linked to metabolic rate, body size, and other physiologic variables (Savage and West 2007). The reciprocal-interaction network structure for regulation of REM bout durations in our model suggests that the activation of LC and DR in response to cholinergic excitation is faster in mice compared to rats. This faster response could be mediated pre-synaptically in the release of ACh to the LC and DR, or postsynaptically in the distribution and kinetics of ACh receptors on the dendrites of LC and DR neurons. Finally, our changes to parameters governing activation levels of the REM-promoting population can be interpreted as suggesting higher firing thresholds and greater threshold variability of neurons in the REM-promoting subpopulations of the LDT and PPT in the mouse compared to the rat.

5.4.4 *Regulation of REM Sleep*

In the sleep research field, there is general consensus that mutually inhibitory projections between wake-promoting populations, including LC and DR, and the NREM sleep-promoting population VLPO are involved in the regulation of transitions between wake and NREM sleep states. There is less consensus regarding the mechanisms involved in the regulation of REM sleep. The network structure we consider here is based on the classical cholinergic hypothesis of REM sleep regulation originally proposed by McCarley and Hobson (Hobson et al. 1975;

McCarley and Hobson 1975). However, recent experimental evidence has challenged the cholinergic hypothesis. The role of the neurotransmitter GABA in silencing activity in LC and DR (Nitz and Siegel 1997; Gervasoni et al. 1998), and thereby gating the production of REM sleep, has led to a focus on REM active GABAergic populations and their roles in proposed conceptual models of REM sleep regulation (Lu et al. 2006; Luppi et al. 2006; Brown et al. 2008; Sapin et al. 2009). These alternate conceptual models ascribe to the cholinergic system varying levels of involvement (reviewed in Diniz Behn and Booth 2010).

Our model analysis has indicated that obtaining appropriate REM sleep structure and patterning across circadian phases and across rodent species sensitively depends on specific network structure. Ongoing experimental work will help to refine the anatomy relevant to different proposed conceptual models for REM regulation, but without formal dynamic modeling it can be difficult to infer the full spectrum of implications associated with a given model. By comparing network flexibility with respect to the characteristics of REM sleep patterning across species and under circadian modulation, modeling can clarify possibilities subject to anatomical and physiological constraints.

References

- Abrahamson EE, Leak RK, Moore RY (2001) The suprachiasmatic nucleus projects to posterior hypothalamic arousal systems. *Neuroreport* 12:435–440
- Arnsten AF, Goldman-Rakic PS (1984) Selective prefrontal cortical projections to the region of the locus coeruleus and raphe nuclei in the rhesus monkey. *Brain Res* 306:9–18
- Aston-Jones G, Bloom FE (1981) Activity of norepinephrine-containing locus coeruleus neurons in behaving rats anticipates fluctuations in the sleep–waking cycle. *J Neurosci* 1:876–886
- Basheer R, Strecker RE, Thakkar MM, McCarley RW (2004) Adenosine and sleep–wake regulation. *Prog Neurobiol* 73:379–396
- Blanco-Centurion C, Gerashchenko D, Shiromani P (2007) Effects of saporin-induced lesions of three arousal populations on daily levels of sleep and wake. *J Neurosci* 27:14,041–14,048
- Brown RE, McKenna JT, Winston S, Basheer R, Yanagawa Y, Thakkar MM, McCarley RW (2008) Characterization of gabaergic neurons in rapid-eye-movement sleep controlling regions of the brainstem reticular formation in gad67-green fluorescent protein knock-in mice. *Eur J Neurosci* 27:352–363
- Burlet S, Tyler CJ, Leonard CS (2002) Direct and indirect excitation of laterodorsal tegmental neurons by hypocretin/orexin peptides: implications for wakefulness and narcolepsy. *J Neurosci* 22:2862–2872
- Carskadon MA, Dement WC (2000) Normal human sleep: An overview. In: Kryger M, Roth T, Dement WC (eds) *Principles and practice of sleep medicine*, 3rd edn. Saunders, New York, pp 15–25
- Chamberlin NL, Arrigoni E, Chou TC, Scammell TE, Greene RW, Saper CB (2003) Effects of adenosine on gabaergic synaptic inputs to identified ventrolateral preoptic neurons. *Neuroscience* 119:913–918
- Chou TC, Scammell TE, Gooley JJ, Gaus SE, Saper CB, Lu J (2003) Critical role of dorsomedial hypothalamic nucleus in a wide range of behavioral circadian rhythms. *J Neurosci* 23:10,691–10,702
- Dai J, Swaab DF, Buijs RM (1997) Distribution of vasopressin and vasoactive intestinal polypeptide (vip) fibers in the human hypothalamus with special emphasis on suprachiasmatic nucleus efferent projections. *J Comp Neurol* 383:397–414

- Dayan P, Abbott LF (2001) *Theoretical neuroscience: computational and mathematical modeling of neural systems*. MIT Press, Cambridge
- Deboer T, Vansteensel MJ, Detari L, Meijer JH (2003) Sleep states alter activity of suprachiasmatic nucleus neurons. *Nat Neurosci* 6:1086–1090
- Deco G, Jirsa VK, Robinson PA, Breakspear M, Friston K (2008) The dynamic brain: from spiking neurons to neural masses and cortical fields. *PLoS Comput Biol* 4:e1000092
- Deurveilher S, Semba K (2005) Indirect projections from the suprachiasmatic nucleus to major arousal-promoting cell groups in rat: Implications for the circadian control of behavioural state. *Neuroscience* 130:165–183
- Dijk DJ, Kronauer RE (1999) Commentary: models of sleep regulation: successes and continuing challenges. *J Biol Rhythms* 14:569–573
- Diniz Behn CG, Booth V (2010) Simulating microinjection experiments in a novel model of the rat sleep–wake regulatory network. *J Neurophysiol* 103:1937–1953
- Diniz Behn CG, Brown EN, Scammell TE, Kopell NJ (2007) A mathematical model of network dynamics governing mouse sleep–wake behavior. *J Neurophysiol* 97:3828–3840
- Ermentrout GB (1998) Neural networks as spatio-temporal pattern forming systems. *Rep Prog Phys* 61:355–430
- Espana RA, Reis KM, Valentino RJ, Berridge CW (2004) Organization of hypocretin/orexin efferents to locus coeruleus and basal forebrain arousal-related structures. *J Comp Neurol* 481:160–178
- Franken P, Malafosse A, Tafti M (1999) Genetic determinants of sleep regulation in inbred mice. *Sleep* 22:155–169
- Gallopín T, Luppi PH, Cauli B, Urade Y, Rossier J, Hayaishi O, Lambollez B, Fort P (2005) The endogenous somnogen adenosine excites a subset of sleep-promoting neurons via a2a receptors in the ventrolateral preoptic nucleus. *Neuroscience* 134:1377–1390
- Gervasoni D, Darracq L, Fort P, Souliere F, Chouvet G, Luppi PH (1998) Electrophysiological evidence that noradrenergic neurons of the rat locus coeruleus are tonically inhibited by GABA during sleep. *Eur J Neurosci* 10:964–970
- Gillette MU, Reppert SM (1987) The hypothalamic suprachiasmatic nuclei: circadian patterns of vasopressin secretion and neuronal activity in vitro. *Brain Res Bull* 19:135–139
- Hobson JA, McCarley RW, Wyzinski PW (1975) Sleep cycle oscillation: reciprocal discharge by two brainstem neuronal groups. *Science* 189:55–58
- Horvath T, Peyron C, Diano S, Ivanov A, Aston-Jones G, Kilduff T, van Den Pol A (1999) Hypocretin (orexin) activation and synaptic innervation of the locus coeruleus noradrenergic system. *J Comp Neurol* 415:145–159
- Hu WP, Li JD, Zhang C, Boehmer L, Siegel JM, Zhou QY (2007) Altered circadian and homeostatic sleep regulation in prokineticin 2-deficient mice. *Sleep* 30:247–256
- Huang ZL, Urade Y, Hayaishi O (2007) Prostaglandins and adenosine in the regulation of sleep and wakefulness. *Curr Opin Pharmacol* 7:33–38
- Jodo E, Chiang C, Aston-Jones G (1998) Potent excitatory influence of prefrontal cortex activity on noradrenergic locus coeruleus neurons. *Neuroscience* 83:63–79
- Kriegsfeld LJ, Leak RK, Yackulic CB, LeSauter J, Silver R (2004) Organization of suprachiasmatic nucleus projections in Syrian hamsters (*Mesocricetus auratus*): an anterograde and retrograde analysis. *J Comp Neurol* 468:361–379
- Lo CC, Chou T, Penzel T, Scammell TE, Strecker RE, Stanley HE, Ivanov P (2004) Common scale-invariant patterns of sleep–wake transitions across mammalian species. *Proc Natl Acad Sci USA* 101:17,545–17,548
- Lu J, Sherman D, Devor M, Saper CB (2006) A putative flip-flop switch for control of REM sleep. *Nature* 441:589–594
- Luppi PH, Gervasoni D, Verret L, Goutagny R, Peyron C, Salvert D, Leger L, Fort P (2006) Paradoxical (rem) sleep genesis: the switch from an aminergic-cholinergic to a gabaergic-glutamatergic hypothesis. *J Physiol (Paris)* 100:271–283
- Lytic R, Baghdoyan HA (1993) Pedunculopontine stimulation alters respiration and increases ACh release in the pontine reticular formation. *Am J Physiol* 264:R544–554

- Lydic R, Baghdoyan HA (2005) Sleep, anesthesiology, and the neurobiology of arousal state control. *Anesthesiology* 103:1268–1295
- Massaquoi SG, McCarley RW (1992) Extension of the limit cycle reciprocal interaction model of REM cycle control. An integrated sleep control model. *J Sleep Res* 1:138–143
- McCarley RW, Hobson JA (1975) Neuronal excitability modulation over the sleep cycle: a structural and mathematical model. *Science* 189:58–60
- Mistlberger RE (2005) Circadian regulation of sleep in mammals: role of the suprachiasmatic nucleus. *Brain Res Rev* 49:429–454
- Mochizuki T, Crocker A, McCormack S, Yanagisawa M, Sakurai T, Scammell TE (2004) Behavioral state instability in orexin knock-out mice. *J Neurosci* 24:6291–6300
- Morairty S, Rainnie D, McCarley R, Greene R (2004) Disinhibition of ventrolateral preoptic area sleep-active neurons by adenosine: a new mechanism for sleep promotion. *Neuroscience* 123:451–457
- Nitz D, Siegel J (1997) GABA release in the dorsal raphe nucleus: role in the control of REM sleep. *Am J Physiol* 273:R451–455
- Phillips AJ, Robinson PA (2007) A quantitative model of sleep–wake dynamics based on the physiology of the brainstem ascending arousal system. *J Biol Rhythms* 22:167–179
- Rempe MJ, Best J, Terman D (2010) A mathematical model of the sleep/wake cycle. *J Math Biol* 60(5):615–644
- Saper CB, Chou TC, Scammell TE (2001) The sleep switch: hypothalamic control of sleep and wakefulness. *Trends Neurosci* 24:726–731
- Saper CB, Scammell TE, Lu J (2005) Hypothalamic regulation of sleep and circadian rhythms. *Nature* 437:1257–1263
- Sapin E, Lapray D, Berod A, Goutagny R, Leger L, Ravassard P, Clement O, Hanriot L, Fort P, Luppi PH (2009) Localization of the brainstem gabaergic neurons controlling paradoxical (REM) sleep. *PLoS ONE* 4:e4272
- Savage VM, West GB (2007) A quantitative, theoretical framework for understanding mammalian sleep. *Proc Natl Acad Sci USA* 104:1051–1056
- Schwartz WJ, Reppert SM, Eagan SM, Moore-Ede MC (1983) In vivo metabolic activity of the suprachiasmatic nuclei: a comparative study. *Brain Res* 274:184–187
- Siegel JM (2005) Clues to the functions of mammalian sleep. *Nature* 437:1264–1271
- Stephan FK, Berkley KJ, Moss RL (1981) Efferent connections of the rat suprachiasmatic nucleus. *Neuroscience* 6:2625–2641
- Steriade M, McCarley RW (1990) Brainstem control of wakefulness and sleep. Plenum, New York
- Sterman MB, Knauss T, Lehmann D, Clemente CD (1965) Circadian sleep and waking patterns in the laboratory cat. *Electroencephalogr Clin Neurophysiol* 19:509–517
- Sun X, Whitefield S, Rusak B, Semba K (2001) Electrophysiological analysis of suprachiasmatic nucleus projections to the ventrolateral preoptic area in the rat. *Eur J Neurosci* 14:1257–1274
- Tamakawa Y, Karashima A, Koyama Y, Katayama N, Nakao M (2006) A quartet neural system model orchestrating sleep and wakefulness mechanisms. *J Neurophysiol* 95:2055–2069
- Thakkar MM, Strecker RE, McCarley RW (1998) Behavioral state control through differential serotonergic inhibition in the mesopontine cholinergic nuclei: a simultaneous unit recording and microdialysis study. *J Neurosci* 18:5490–5497
- van Twyver H (1969) Sleep patterns of five rodent species. *Physiol Behav* 4:901–905
- Weitzman ED, Czeisler CA, Zimmerman JC, Ronda J (1980) The timing of REM sleep and its relation to spontaneous awakenings during temporal isolation in man. *Sleep Res* 9:280
- Wexler DB, Moore-Ede MC (1985) Circadian sleep–wake cycle organization in squirrel monkeys. *Am J Physiol* 248:R353–362
- Wilson HR, Cowan JD (1972) Excitatory and inhibitory interactions in localized populations of model neurons. *Biophys J* 12:1–24
- Zepelin H, Siegel J, Tobler I (2005) Mammalian sleep. In: Kryger M, Roth T, Dement WC (eds) *Principles and practice of sleep medicine*, 4th edn. Elsevier/Saunders, Philadelphia, pp 91–100

Chapter 6

Neural Correlates of Human NREM Sleep Oscillations

A. Foret, A. Shaffii-Le Bourdieu, V. Muto, L. Mascetti, L. Matarazzo, C. Kussé, and P. Maquet

6.1 Introduction

Behaviorally, sleep is a normal, reversible, periodically recurring behavior characterized by a decreased responsiveness to external stimuli, a diminished motor activity and a characteristic position. Sleep is often preceded by the active retreat to a safe, secluded place. It is homeostatically regulated in such a way that any extension of the waking period is followed by an increase in sleep depth and (to some extent) duration (Borbely 1982). In homeotherms, additional neurophysiological parameters allow one to recognize two main sleep states: a “regular” sleep, also known as non rapid eye movement (NREM) sleep which shows gradual changes in sleep depth, and a ‘paradoxical’ sleep or rapid eye movement (REM) sleep, which combines nearly complete paralysis of the musculature, bursts of rapid eye movements with elevated brain activity (Aserinsky and Kleitman 2003).

Because sleep is observed in a large number of species (Mammals and Birds but also Reptiles, Fishes and even Invertebrates), it is thought to provide a substantial adaptive advantage to these species and thus to support an important physiological function. Accordingly, prolonged sleep deprivation leads rats to die within a few weeks (Rechtschaffen et al. 1989). Although numerous hypotheses have been proposed over the years, the functions of sleep are not yet fully specified.

A deeper understanding of sleep certainly requires the characterization of specific sleep rhythms. In this chapter, we focus on NREM sleep oscillations: slow waves and spindles. In a first section, we briefly review their cellular mechanisms.¹ The

¹Cf. Chap. 4 by Alain Destexhe and Diego Contreras.

P. Maquet (✉)

Cyclotron Research Centre, University of Liège, 8, Allée du 6 Août, 4000 Liège, Belgium

e-mail: pmaquet@ulg.ac.be

url: <http://www.ulg.ac.be/crc>

second section offers a description of their cerebral correlates in humans. The last part of the chapter deals with the functional significance of NREM sleep oscillation for brain function.

6.2 NREM Sleep Oscillations: Definitions and Neural Mechanisms

In humans, NREM sleep is further divided in three stages (Rechtschaffen and Kales 1968). Stage 1 sleep corresponds to somnolence and technically is not considered as proper sleep. NREM sleep is arbitrarily constituted of light sleep (stage 2 sleep) and deep slow-wave sleep (SWS, stages 3 and 4 sleep). Light and deep NREM sleep are defined by EEG criteria but are essentially characterized by two main oscillations, sleep spindles and the slow oscillation, the abundance of which varies on EEG recordings as sleep deepens.

6.2.1 *The Slow Rhythm (<1 Hz) and Slow Waves*

The slow rhythm (<1 Hz) constitutes the fundamental rhythm which characterizes NREM sleep. Originally, unit recordings in cats showed that neuronal membrane potential oscillates at low frequency (around 1 Hz). This oscillation shapes neuronal activity, by alternating a depolarizing phase, associated with important neuronal firing (“up state”), and a hyperpolarizing phase, during which cortical neurons remain silent for a few hundred milliseconds (“down state”) (Steriade et al. 1993b; Steriade et al. 2001). This so-called slow oscillation (<1 Hz) is recorded during NREM sleep in all major types of neocortical neurons (both excitatory and inhibitory) and occurs synchronously in large neuronal populations. At the population level, the activity is therefore made up of the alternation of ‘ON’ states and ‘OFF’ states’. Because these events represent massive and synchronous changes in large neuronal populations, they can be reflected on EEG recordings as large amplitude low frequency waves (Steriade et al. 1993a). The slow oscillation is generated by the cortex as can be observed after thalamic destruction (Steriade et al. 1993a), in cortical slabs isolated from thalamic influence (Timofeev et al. 2000) or in cortical slices (Sanchez-Vives and McCormick 2000). However, two intrinsic conditional thalamic oscillators also participate in the generation of the slow oscillation (Crunelli and Hughes 2009).

In humans, the taxonomy of SWS waves is not always clear. A slow rhythm was initially identified on scalp EEG recordings as the recurrence of spindles (Achermann and Borbely 1997) or their grouping by slow waves (Molle et al. 2002). More recently, high amplitude slow waves themselves were taken as realization of the slow rhythm (Massimini et al. 2004). On the other hand, historically, the power

density in the 0.75–4 Hz frequency band, usually referred to as ‘slow-wave activity’ (SWA), has proved a very useful and popular parameter because it quantifies the dissipation of homeostatic sleep pressure during NREM sleep (Borbely 2001). The frequency bounds of SWA do not respect the dichotomy between slow (<1 Hz) and delta rhythms (1–4 Hz), which is based on differences in the respective cellular correlates of these rhythms in animals (Steriade and McCarley 2005). In the temporal domain, the amplitude of SWS waves is classically larger than 75 μ V (Rechtschaffen and Kales 1968) but only the largest waves (>140 μ V) were taken as realizations of the slow oscillation (<1 Hz) (Molle et al. 2002; Massimini et al. 2004). This approach suggests that relatively smaller waves (amplitude between 75 and 140 μ V) correspond to delta waves (1–4 Hz). These faster waves of smaller amplitude would also be an expression of the slow oscillation but arise when the synchronization in the network is less marked (Esser et al. 2007; Vyazovskiy et al. 2009).

6.2.2 Spindles

Spindles constitute the hallmark of light NREM sleep, although they can still be detected in lower amounts during SWS. In humans, spindles consist of waxing-and-waning 11–15 Hz oscillations, lasting 0.5 to 3 seconds. At the cellular level, spindles arise from cyclic inhibition of thalamo-cortical (TC) neurons by reticular thalamic (RT) neurons. Post-inhibitory rebound spike bursts in TC cells entrain cortical populations in spindle oscillations (Steriade and McCarley 2005). In addition, two kinds of spindles are described in humans. Slow spindles (grossly <13 Hz) predominate over frontal areas, whereas fast spindles (>13 Hz) prevail over centro-parietal areas. These two spindling activities differ by their circadian and homeostatic regulations, pharmacological reactivity, development in infancy, evolution during aging, modulation during menstrual cycle and pregnancy (De Gennaro and Ferrara 2003) and intriguingly, by their association with general cognitive capabilities (Bodizs et al. 2005) and memory processing (Schabus 2009). Despite these functional differences, it is still debated whether slow and fast spindles reflect the activity of different neural networks or the differential modulation of a single generator.

6.2.2.1 Coalescence of NREM Sleep Rhythms

At the cellular level, the slow rhythm organizes other NREMS oscillations in a coalescence of rhythms so that spindles and gamma oscillations are more likely to occur during the up phase of the slow oscillation (Steriade and Amzica 1998; Molle et al. 2002). Likewise, hippocampal activity during NREMS is characterized by sharp waves and ripples, which are synchronous to the cortical slow oscillation (Isomura et al. 2006; Molle et al. 2006; Clemens et al. 2007), although it is not yet clear which oscillation is driving the other (Isomura et al. 2006; Tononi et al. 2006). Finally, the slow oscillation organizes the neural firing of arousing structures such as the locus coeruleus (LC) (Eschenko and Sara 2008).

6.3 Functional Neuroimaging of NREM Sleep Oscillations

6.3.1 *The Slow Rhythm*

On scalp EEG recording, SWA predominates over frontal areas (Finelli et al. 2001), where indeed the largest waves are typically recorded. However, an analysis of individual waves demonstrated the spatial variability of slow waves. Each wave originates at a specific site and travels over the scalp following a particular trajectory (Massimini et al. 2004). Waves originate more frequently in frontal regions and travel backwards to posterior areas. Beyond this variability, slow waves seem to recruit systematically various brain regions. Early studies based on cerebral blood flow measurement by positron emission tomography (PET) reported that the power density of delta waves (1.5–4 Hz) during NREM sleep was negatively correlated with rCBF in the ventromedial prefrontal cortex, the basal forebrain, the striatum, the anterior insula, and the precuneus (Dang-Vu et al. 2005). Using simultaneous EEG and event-related functional magnetic resonance imaging (fMRI), it was possible to show that slow waves were associated with transient increases in regional brain activity, in keeping with animal data (Dang-Vu et al. 2008), cf. Fig. 6.1. Slow waves were associated with significant increases in activity in inferior and medial frontal cortices, precuneus and posterior cingulate. As compared to baseline activity, the largest waves ($>140 \mu\text{V}$) were associated with significant activity in the parahippocampal gyrus, cerebellum and brainstem whereas delta waves were related to frontal responses. Source reconstruction of scalp high density EEG recordings confirmed these results. Although slow waves originate more frequently in the insula and cingulate gyrus, they preferentially involve the precuneus, the posterior cingulate, ventro-lateral and medial frontal areas (Murphy et al. 2009). It is currently believed that these areas constitute a preferred propagation pathway because they correspond to major structural connectivity nodes in the human brain (Murphy et al. 2009).

6.3.2 *Spindles*

Little is known on the cerebral correlates of human spindles. Scalp multi-channel EEG recordings showed that slow spindles (centered around 12 Hz) exhibit a variable topography, primarily over the frontal cortex (Doran 2003). Fast spindles (centered at 14 Hz) are topographically and dynamically limited to the superior central and parietal cortex (Doran 2003). Source reconstruction of scalp EEG recordings identified two sources, one for slow spindles in a mesial frontal region and another for fast spindles in the precuneus (Anderer et al. 2001). Early PET studies reported a negative relationship between thalamic cerebral blood flow and the power spectrum in the spindle frequency band (Hofle et al. 1997). Taking advantage of the high temporal resolution of EEG/fMRI, it was later shown that human spindles were also associated with transient surge in activity in the thalamic, paralimbic areas (anterior

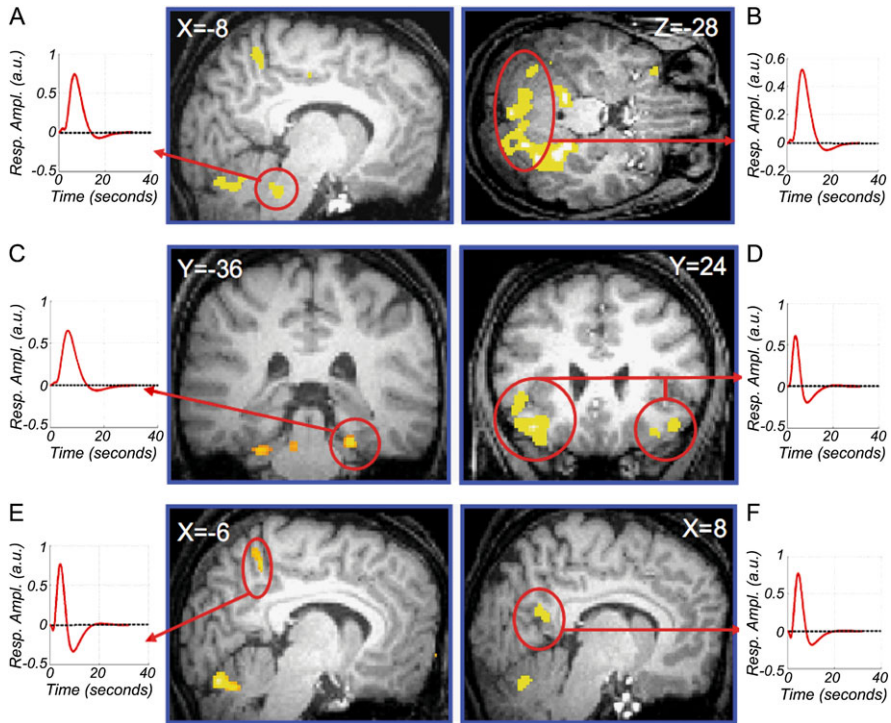

Fig. 6.1 *Central panels:* Brain responses to NREM sleep slow waves. *Side panels:* Time course (in seconds) of fitted response amplitudes (in arbitrary units) during slow oscillation in the corresponding circled brain area. All responses consisted in regional increases of brain activity. **A**, pontine tegmentum; **B**, cerebellum; **C**, right parahippocampal gyrus; **D**, inferior frontal gyrus; **E**, pre-cuneus; **F**, posterior cingulate cortex. Adapted from Dang-Vu et al. (2008)

cingulate and insular cortices) and superior temporal gyri (Schabus et al. 2007), cf. Fig. 6.2. Slow spindles were further associated with increased activity in the superior frontal gyrus. In contrast, fast spindles recruited a set of cortical regions involved in sensorimotor processing, as well as the mesial frontal cortex and hippocampus. The recruitment of partially segregated cortical networks for slow and fast spindles further supports the existence of two spindle types during human NREM sleep, with potentially different functional significance.

6.4 Functional Significance of NREM Sleep Oscillations

6.4.1 Slow Waves

An inspiring hypothesis assumes that during NREM sleep, the slow oscillation would be associated with a downscaling of synaptic strength to a baseline level,

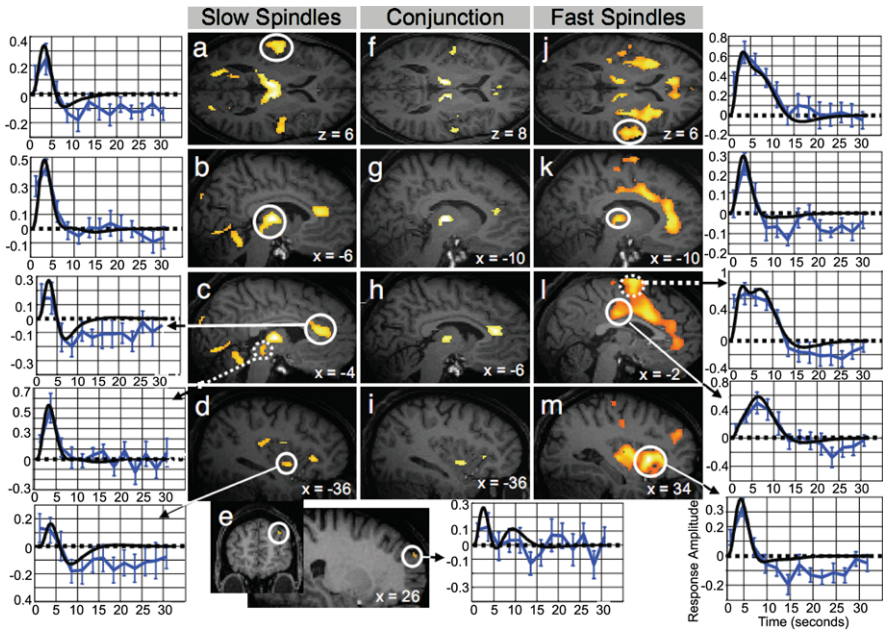

Fig. 6.2 *Left panels (a–e):* fMRI responses to slow spindles. *Leftmost panels:* Responses time course in (a) auditory cortices (circled), (b) thalamus, (c) anterior cingulate (circled) and midbrain tegmentum (dotted), as well as (d) anterior insula and (e) superior frontal gyrus (circled). *Center panels (f–i):* Common response pattern to all spindles. *Right panels (j–m):* fMRI responses to fast spindles. *Rightmost panels:* response time course in (j) superior temporal gyri, (k) thalami, (l) mid cingulate cortex (circled) and supplementary motor area (dotted), as well as (m) anterior insula. Adapted from Schabus et al. (2007)

a process beneficial for learning and memory. The synaptic downscaling would be a general phenomenon occurring throughout the brain which is modulated locally by the amount of neural activity and synaptic strength enhancement accumulated during the day. Wakefulness is associated with a net increase in synaptic strength in the brain, which would become energetically unsustainable in the long term (Tononi and Cirelli 2003, 2006). In support of this hypothesis, an increase in SWA, the power density between 0.75 and 4 Hz during NREMS, is selectively observed after training to a visuo-motor adaptation task, over scalp areas that are deemed critical in this type of learning (Huber et al. 2004). In contrast, arm immobilization results in a decrease in SWA over contralateral sensorimotor areas during subsequent NREMS (Huber et al. 2006). Local increases in SWA were also reported when cortical activity is experimentally induced by a vibratory stimulation of the hand, transcranial magnetic stimulation or when spike timing dependent activity is elicited during waking by transcranial paired associative stimulation (Huber et al. 2007b). Similar increases in SWA were reported in rats exposed to enriched environment and seem associated with release of BDNF (Huber et al. 2007a). At the cellular level, the slope and amplitude of cortical evoked responses, taken as markers of local synaptic strength,

increase after wakefulness and decrease after sleep in proportion with changes in SWA (Vyazovskiy et al. 2008). At the cellular level, multi-unit recordings showed that firing rates and synchrony decrease after sleep. Changes in firing patterns in NREM sleep correlate with changes in slow-wave activity (Vyazovskiy et al. 2009). At the molecular level, in rat cortex and hippocampus, GluR1-containing AMPA receptor (AMPA) levels are high during wakefulness and low during sleep, and changes in the phosphorylation states of AMPARs, CamKII and GSK3beta are consistent with synaptic potentiation during wakefulness and depression during sleep (Vyazovskiy et al. 2009).

Another hypothesis assumes that sleep participates in this systems-level memory consolidation by promoting the functional interplay between hippocampal neural ensembles and neocortical areas (Buzsaki 1996). Indeed, the up-state of the cortical slow oscillation constitutes a remarkable period during which the activity of various brain structures, in the cortex (slow waves, spindles), the hippocampus (sharp-wave ripples) and subcortical structures (striatum, LC) is synchronized, thereby fostering functional interactions associated with systems-level memory consolidation (Diekelmann et al. 2010).

A key finding supporting this hypothesis was that sequences of neural discharges recorded in neural ensembles during wakefulness were spontaneously repeated during sleep, especially during hippocampal sharp waves and ripples, which are coherent with cortical slow oscillation observed in various brain structures such as the hippocampus (Hirase et al. 2001), neocortical areas (Euston et al. 2007), the thalamus (Ribeiro et al. 2004) or the striatum (Lansink et al. 2009). Importantly, reactivation of firing patterns in the neocortex is synchronized to hippocampal sharp waves (Ji and Wilson 2007; Wierzynski et al. 2009), a condition favorable to cortico-hippocampal interactions. In addition, these reactivations seem to depend on learning as the replayed firing patterns appear only after the acquisition of new rules (Peyrache et al. 2009). Collectively, these data support the hypothesis that during sleep, hippocampo-neocortical interactions may progressively transfer the burden of memory from hippocampal ensembles to long-term neocortical stores. In keeping with this hypothesis, in humans, after the exploration of a virtual tridimensional maze the activity is enhanced during NREMS in occipital, parietal and mesio-temporal areas (Peigneux et al. 2004). Moreover, the increase in hippocampal activity is linearly related to the individual gain in the ability to navigate in the maze the next day, suggesting that the changes in hippocampal activity during NREMS relates to the offline processing of topographical memory.

6.4.2 *Spindles*

Because spindles entrain synchronous firing in large thalamo-cortical neural populations, they are in a good position to allow for the modifications in the neural representations of recent memories. In support to this hypothesis, spindle activity increases after training on declarative (Gais et al. 2002; Schmidt et al. 2006;

Schabus 2009) and procedural (Fogel and Smith 2006; Fogel et al. 2007) memory tasks. Enhancing slow oscillations by direct current transcranial stimulation increases the power in the spindle frequency band and leads to a better retention of declarative memory the next morning (Marshall et al. 2006). At the cellular level, it was shown that repetitive spike bursts mimicking firing patterns observed during spontaneous spindles reliably induced short- and long-term potentiation in cortical neurons of rat brain slices (Rosanova and Ulrich 2005). It has also been suggested that activity in the spindle band would trigger molecular cascades involved in brain plasticity by increasing intracellular calcium levels (Sejnowski and Destexhe 2000).

6.5 Conclusion

Recent advances were recently made in the characterization of the neural correlates of NREM sleep oscillation in both animals and humans. They provide some hint on why sleep is important for optimal waking brain function. Further research is needed to characterize the difference in functional consequences between natural sleep oscillations and EEG rhythms recorded in other altered states of consciousness, including in general anesthesia, vegetative or minimally conscious patients.

Acknowledgements Personal research reported in this review was supported by the Belgian Fonds National de la Recherche Scientifique (F.N.R.S), Fondation Médicale Reine Elisabeth (FMRE), Research Fund of the University of Liège and 'Interuniversity Attraction Poles Programme – Belgian State – Belgian Science Policy'. AF, ASLB, LaM, LuM, CK and PM are supported by the F.N.R.S.

References

- Achermann P, Borbely AA (1997) Low-frequency (<1 Hz) oscillations in the human sleep electroencephalogram. *Neuroscience* 81:213–222
- Anderer P, Klosch G, Gruber G, Trenker E, Pascual-Marqui RD, Zeitlhofer J, Barbanoj MJ, Rappelsberger P, Saletu B (2001) Low-resolution brain electromagnetic tomography revealed simultaneously active frontal and parietal sleep spindle sources in the human cortex. *Neuroscience* 103:581–592
- Aserinsky E, Kleitman N (2003) Regularly occurring periods of eye motility, and concomitant phenomena, during sleep. *J Neuropsychiatry Clin. Neuroscience* 15:454–455
- Bodizs R, Kis T, Lazar AS, Havran L, Rigo P, Clemens Z, Halasz P (2005) Prediction of general mental ability based on neural oscillation measures of sleep. *J Sleep Res* 14:285–292
- Borbely AA (1982) A two process model of sleep regulation. *Hum Neurobiol* 1:195–204
- Borbely AA (2001) From slow waves to sleep homeostasis: new perspectives. *Arch Ital Biol* 139:53–61
- Buzsaki G (1996) The hippocampo-neocortical dialogue. *Cereb Cortex* 6:81–92
- Clemens Z, Molle M, Eross L, Barsi P, Halasz P, Born J (2007) Temporal coupling of parahippocampal ripples, sleep spindles and slow oscillations in humans. *Brain* 130:2868–2878
- Crunelli V, Hughes SW (2009) The slow (<1 Hz) rhythm of non-REM sleep: a dialogue between three cardinal oscillators. *Nat Neurosci* 13:9–17

- Dang-Vu TT, Desseilles M, Laureys S, Degueldre C, Perrin F, Phillips C, Maquet P, Peigneux P (2005) Cerebral correlates of delta waves during non-rem sleep revisited. *Neuroimage* 28:14–21
- Dang-Vu TT, Schabus M, Desseilles M, Albouy G, Boly M, Darsaud A, Gais S, Rauchs G, Sterpenich V, Vandewalle G, Carrier J, Moonen G, Balteau E, Degueldre C, Luxen A, Phillips C, Maquet P (2008) Spontaneous neural activity during human slow wave sleep. *Proc Natl Acad Sci USA* 105:15,160–15,165
- De Gennaro L, Ferrara M (2003) Sleep spindles: an overview. *Sleep Med Rev* 7:423–440
- Diekelmann S, Born J, Wagner U (2010) Sleep enhances false memories depending on general memory performance. *Behav Brain Res* 208(2):425–429
- Doran S (2003) The dynamic topography of individual sleep spindles. *Sleep Res Online* 5:133–139
- Eschenko O, Sara SJ (2008) Learning-dependent, transient increase of activity in noradrenergic neurons of locus coeruleus during slow wave sleep in the rat: Brain stem-cortex interplay for memory consolidation? *Cereb Cortex* 18(11):2596–2603
- Esser SK, Hill SL, Tononi G (2007) Sleep homeostasis and cortical synchronization: I modeling the effects of synaptic strength on sleep slow waves. *Sleep* 30:1617–1630
- Euston DR, Tatsuno M, McNaughton B (2007) Fast-forward playback of recent memory sequences in prefrontal cortex during sleep. *Science* 318:1147–1150
- Finelli LA, Borbely AA, Achermann P (2001) Functional topography of the human nonREM sleep electroencephalogram. *Eur J Neurosci* 13:2282–2290
- Fogel SM, Smith CT (2006) Learning-dependent changes in sleep spindles and stage 2 sleep. *J Sleep Res* 15:250–255
- Fogel SM, Smith CT, Cote KA (2007) Dissociable learning-dependent changes in REM and non-REM sleep in declarative and procedural memory systems. *Behav Brain Res* 180:48–61
- Gais S, Molle M, Helms K, Born J (2002) Learning-dependent increases in sleep spindle density. *J Neurosci* 22:6830–6834
- Hirase H, Leinekugel X, Czurko A, Csicsvari J, Buzsaki G (2001) Firing rates of hippocampal neurons are preserved during subsequent sleep episodes and modified by novel awake experience. *Proc Natl Acad Sci USA* 98:9386–9390
- Hofle N, Paus T, Reutens D, Fiset P, Gotman J, Evans AC, Jones BE (1997) Regional cerebral blood flow changes as a function of delta and spindle activity during slow wave sleep in humans. *J Neurosci* 17:4800–4808
- Huber R, Ghilardi MF, Massimini M, Tononi G (2004) Local sleep and learning. *Nature* 430:78–81
- Huber R, Ghilardi MF, Massimini M, Ferrarelli F, Riedner BA, Peterson MJ, Tononi G (2006) Arm immobilization causes cortical plastic changes and locally decreases sleep slow wave activity. *Nat Neurosci* 9:1169–1176
- Huber R, Esser SK, Ferrarelli F, Massimini M, Peterson MJ, Tononi G (2007a) TMS-induced cortical potentiation during wakefulness locally increases slow wave activity during sleep. *PLoS ONE* 2:e276
- Huber R, Tononi G, Cirelli C (2007b) Exploratory behavior, cortical bdnf expression, and sleep homeostasis. *Sleep* 30:129–139
- Isomura Y, Sirota A, Ozen S, Montgomery S, Mizuseki K, Henze DA, Buzsaki G (2006) Integration and segregation of activity in entorhinal-hippocampal subregions by neocortical slow oscillations. *Neuron* 52:871–882
- Ji D, Wilson MA (2007) Coordinated memory replay in the visual cortex and hippocampus during sleep. *Nat Neurosci* 10:100–107
- Lansink CS, Goltstein PM, Lankelma JV, McNaughton BL, Pennartz CM (2009) Hippocampus leads ventral striatum in replay of place-reward information. *PLoS Biol* 7:e1000,173
- Marshall L, Helgadottir H, Molle M, Born J (2006) Boosting slow oscillations during sleep potentiates memory. *Nature* 444:610–613
- Massimini M, Huber R, Ferrarelli F, Hill S, Tononi G (2004) The sleep slow oscillation as a traveling wave. *J Neurosci* 24:6862–6870
- Molle M, Marshall L, Gais S, Born J (2002) Grouping of spindle activity during slow oscillations in human non-rapid eye movement sleep. *J Neurosci* 22:10,941–10,947

- Molle M, Yeshenko O, Marshall L, Sara SJ, Born J (2006) Hippocampal sharp wave-ripples linked to slow oscillations in rat slow-wave sleep. *J Neurophysiol* 96:62–70
- Murphy M, Riedner BA, Huber R, Massimini M, Ferrarelli F, Tononi G (2009) Source modeling sleep slow waves. *Proc Natl Acad Sci USA* 106:1608–1613
- Peigneux P, Laureys S, Fuchs S, Collette F, Perrin F, Reggers J, Phillips C, Degueldre C, Del Fiore G, Aerts J, Luxen A, Maquet P (2004) Are spatial memories strengthened in the human hippocampus during slow wave sleep? *Neuron* 44:535–545
- Peyrache A, Khamassi M, Benchenane K, Wiener S, Battaglia F (2009) Replay of rule-learning related neural patterns in the prefrontal cortex during sleep. *Nat Neurosci* 12:919–926
- Rechtschaffen A, Kales A (1968) A manual of standardized terminology, techniques and scoring system for sleep stages of human subjects. Brain Information Service/Brain Research Institute, University of California, Los Angeles
- Rechtschaffen A, Bergmann BM, Everson CA, Kushida CA, Gilliland MA (1989) Sleep deprivation in the rat: X. integration and discussion of the findings. *Sleep* 12(1):68–87
- Ribeiro S, Gervasoni D, Soares ES, Zhou Y, Lin SC, Pantoja J, Lavigne M, Nicolelis MA (2004) Long-lasting novelty-induced neuronal reverberation during slow-wave sleep in multiple fore-brain areas. *PLoS Biol* 2:E24
- Rosanova M, Ulrich D (2005) Pattern-specific associative long-term potentiation induced by a sleep spindle-related spike train. *J Neurosci* 25:9398–9405
- Sanchez-Vives MV, McCormick DA (2000) Cellular and network mechanisms of rhythmic recurrent activity in neocortex. *Nat Neurosci* 3:1027–1034
- Schabus M (2009) Still missing some significant ingredients. *Sleep* 32:291–293
- Schabus M, Dang-Vu TT, Albouy G, Baletau E, Boly M, Carrier J, Darsaud A, Degueldre C, Desseilles M, Gais S, Phillips C, Rauchs G, Schnakers C, Sterpenich CS, Vandewalle G, Luxen A, Maquet P (2007) Hemodynamic cerebral correlates of sleep spindles during human non-rapid eye movement sleep. *Proc Natl Acad Sci USA* 104:13,164–13,169
- Schmidt C, Peigneux P, Muto V, Schenkel M, Knoblauch V, Munch M, de Quervain D, Wirz-Justice A, Cajochen C (2006) Encoding difficulty promotes postlearning changes in sleep spindle activity during napping. *J Neurosci* 26:8976–8982
- Sejnowski TJ, Destexhe A (2000) Why do we sleep? *Brain Res* 886:208–223
- Steriade M, Amzica F (1998) Coalescence of sleep rhythms and their chronology in corticothalamic networks. *Sleep Res Online* 1:1–10
- Steriade M, McCarley RW (2005) Brain control of wakefulness and sleep. Kluwer Academic, New York
- Steriade M, Nunez A, Amzica F (1993a) Intracellular analysis of relations between the slow (<1 Hz) neocortical oscillation and other sleep rhythms of the electroencephalogram. *J Neurosci* 13:3266–3283
- Steriade M, Nunez A, Amzica F (1993b) A novel slow (<1 Hz) oscillation of neocortical neurons in vivo: depolarizing and hyperpolarizing components. *J Neurosci* 13:3252–3265
- Steriade M, Timofeev I, Grenier F (2001) Natural waking and sleep states: a view from inside neocortical neurons. *J Neurophysiol* 85:1969–1985
- Timofeev I, Grenier F, Bazhenov M, Sejnowski TJ, Steriade M (2000) Origin of slow cortical oscillations in deafferented cortical slabs. *Cereb Cortex* 10:1185–1199
- Tononi G, Cirelli C (2003) Sleep and synaptic homeostasis: a hypothesis. *Brain Res Bull* 62:143–150
- Tononi G, Cirelli C (2006) Sleep function and synaptic homeostasis. *Sleep Med Rev* 10:49–62
- Tononi G, Massimini M, Riedner BA (2006) Sleepy dialogues between cortex and hippocampus: who talks to whom? *Neuron* 52:748–749
- Vyazovskiy VV, Cirelli C, Pfister-Genskow M, Faraguna U, Tononi G (2008) Molecular and electrophysiological evidence for net synaptic potentiation in wake and depression in sleep. *Nat Neurosci* 11:200–208
- Vyazovskiy VV, Olcese U, Lazimy Y, Faraguna U, Esser SK, Williams J, Cirelli C, Tononi G (2009) Cortical firing and sleep homeostasis. *Neuron* 63:865–878
- Wierzynski CM, Lubenov EV, Gu M, Siapas AG (2009) State-dependent spike-timing relationships between hippocampal and prefrontal circuits during sleep. *Neuron* 61:587–598

Part II

Anesthesia

Chapter 7

A Mesoscopic Modelling Approach to Anaesthetic Action on Brain Electrical Activity

D.T.J. Liley, B.L. Foster, and I. Bojak

Everybody wants to have a hand in the great discovery. All I will do is give you a hint or two as to names, or the name, to be applied to the state produced, and to the agent. The state should, I think, be called anaesthesia.

Oliver Wendell Holmes in a letter to William Morton, 1846

7.1 Introduction

While history records many instances in which various substances such as wine, hemp and opium were used to deaden sensibility to the pain of surgery, it was not until William Morton's public demonstration of the painless extraction of a tooth in 1846 using ether that the modern era of anaesthesia can be said to have begun. Within a few years of this demonstration chloroform, diethyl ether and nitrous oxide had all attained a widespread, and ardent, clinical following. While these initial agents were variously highly toxic (chloroform), combustible (diethyl ether, chloroform) or of insufficient potency (nitrous oxide), by the end of the 20th century a range of intravenous and volatile general anaesthetic agents (GAs) had been developed that had overcome all of these limitations. Anaesthesia is now among the safest of all routine clinical procedures, with the mortality attributable to anaesthesia having fallen dramatically from 1 per 10,000 healthy patients in 1950 (when mortality rates began to be systematically assayed) to less than 1 per 250,000 (Kohn et al. 2000). However, the dramatic advances in the clinical certitude and confidence with which anaesthetic agents are administered have not been paralleled by a similar increase in our knowledge of the neu-

D.T.J. Liley (✉)

Brain and Psychological Sciences Research Centre (BPsyC), Swinburne University of Technology, P.O. Box 218, Hawthorn, VIC 3122, Australia
e-mail: dliley@swin.edu.au

ral mechanisms responsible for their ability to remove consciousness. While the last three decades or so have seen an explosion in our knowledge regarding the molecular and cellular targets of anaesthetic agents (Franks 2008; Ishizawa 2007; Rudolph and Antkowiak 2004; Grasshoff et al. 2005; Hemmings et al. 2005; Campagna et al. 2003; Franks and Lieb 1994), we remain largely ignorant regarding the mechanisms by which these microscopic effects produce alterations in large scale neuronal network activity and hence behavior. Modelling the large scale electrophysiological effects of anaesthetic agents may help to mechanistically unify the multiple cellular and molecular targets of anaesthetic agents that have been identified to date.

7.1.1 Molecular Actions of Anaesthetics

Because a range of structurally unrelated compounds were able to induce anaesthesia it was speculated that they all acted through a common mechanism. This unitary hypothesis of anaesthetic action was further supported by the fact that there was a strong linear relationship between the potency of anaesthetics and their solubility in olive oil. This together with the unitary hypothesis inspired the Meyer–Overton theory of anaesthetic action, in which anaesthetic agents were hypothesized to act by disrupting the structure, and thereby the function, of the bilamellar lipid membrane of neurons (Campagna et al. 2003). While this hypothesis seemed well placed to explain the structural heterogeneity of anaesthetic agents, the failure to predict and thereby account for a number of well established empirical results ultimately lead to the demise of such simplistic speculations.¹ For example, the prediction that the potency of optical isomers of GAs would remain unchanged was violated (Franks and Lieb 1994), as was the prediction that homologous series of anaesthetic alcohols and alkanes would exhibit a steady increase in potency depending on temperature (Koblin et al. 1994).

It is now thought that anaesthetics exert their effects by interacting with specific protein targets through a combination of weak polarization forces (predominantly

¹However, recently there has been renewed interest in such theories, because of the apparent invariance across a range of vertebrates of the concentrations of inhaled anaesthetic agents required to extinguish the response to noxious (painful) stimuli (Eger et al. 2008). The ability of anaesthetic agents to induce such immobility is, together with hypnosis and analgesia, a cardinal feature of anaesthesia. While it is reasonably well established that immobility is mediated at the level of the spinal chord, no present consensus holds regarding the corresponding molecular targets. Because of their ubiquitous phylogenetic potency, evolutionarily highly conserved cellular and/or molecular loci seem necessary (Sonner 2008). It has been suggested that volatile anaesthetics affect highly conserved sodium channels through a nonspecific mechanism, such as being adsorbed into the membrane, with a subsequent alteration of the function of the resident sodium channels and other membrane-bound proteins (Cantor 1997). This is an interesting hypothesis, but difficult to test experimentally: sodium channels are everywhere in the central nervous system and are involved in a wide variety of processes that may, or may not be, relevant to understanding volatile anaesthetic effect, e.g., the genesis of the action potential, presynaptic neurotransmitter release and the postsynaptic actions of a range of excitatory neurotransmitters and neuromodulators such as glutamate and acetylcholine.

London dispersion) and hydrogen bonding (Franks 2008). This explains the correlation between potency and lipid partitioning, since London dispersion forces are the predominant mechanism of interaction between apolar molecules (e.g., anaesthetics and lipids). While a great variety of protein targets have been identified, it appears that proteins associated with neuronal ion channels are the most important targets for the action of anaesthetics (Franks 2008; Rudolph and Antkowiak 2004). High resolution information of the actual anaesthetic binding sites on these ion channel proteins is lacking, but a coherent picture is still emerging: anaesthetics bind preferentially to pre-existing hydrophobic cavities on ion channel proteins which results in alterations of the corresponding gating kinetics. As a consequence modern theories of anaesthetic action have focused upon the modulation of transmembrane ion channel function and its effect on neuronal excitability.

To date the effects anaesthetics have on γ -amino-butyric-acid type A (GABA_A) ionotropic receptors has received the most attention (Rudolph and Antkowiak 2004). It is the most abundant inhibitory neurotransmitter receptor in the central nervous system. Each receptor is a heteropentameric transmembrane protein that has a wide number of subunit compositions, which can influence anaesthetic affinity. To date 19 receptor subunits have been identified, however, the majority of GABA_A receptors are of the form $2\alpha_1 2\beta_2 1\gamma_2$ (Rudolph and Antkowiak 2004). The subunits form a transmembrane channel that becomes permeable to Cl⁻ in response to the binding of the endogenous ligand GABA. Because the extracellular concentration of Cl⁻ is greater than its intracellular concentration it mediates fast (<100 ms) synaptic inhibition (Macdonald 1994). Almost all general anaesthetics prolong GABA-induced Cl⁻ currents, hence GABA_A receptor mediated inhibitory neurotransmission is enhanced.

However, depending on the agent, synaptic GABA_A receptors are neither the major nor the only molecular targets of general anaesthetic action. Additional neuronal molecular targets of anaesthetics that have been identified include extrasynaptic GABA_A receptors (Belelli et al. 2009), two-pore K⁺ channels (2PK) (Bayliss and Barrett 2008), and ionotropic *N*-methyl-D-aspartate (NMDA) (Solt et al. 2006; Jevtovic-Todorovic et al. 1998), glycine (Mihic et al. 1997) and nicotinic acetylcholine (nACh) receptors (Violet et al. 1997). Extrasynaptic GABA_A receptors respond to low fluctuating levels of GABA and are thought to contribute to *tonic inhibition* which is enhanced in response to anaesthetic action. 2PK channels, which are thought to modulate 'background' neuronal excitability, are activated by volatile anaesthetic agents. Postsynaptically this results in diminished neuronal excitability due to either membrane hyperpolarization or the shunting of excitatory postsynaptic currents due to increased membrane conductance. NMDA receptors mediate the slow, voltage dependent, postsynaptic components of the glutamate induced excitatory postsynaptic currents. While most volatile agents inhibit NMDA receptor activity, such inhibition is thought to be particularly relevant for the anaesthetic actions of nitrous oxide and the noble gas xenon. Neuronal nicotinic acetylcholine receptors are ionotropic receptors that, when activated by the binding of endogenously released acetylcholine, are permeable to Na⁺ and K⁺ ions. A variety of volatile and intravenous anaesthetics have been shown to inhibit excitatory postsynaptic cholin-

ergic currents. Glycine ionotropic receptors, which are homologs of GABA_A receptors, are particularly abundant in the brain stem and spinal chord, where they are the major mediators of synaptic inhibition. The enhancement of the synaptic actions of glycine on dorsal horn- and motor-neurons in the spinal chord is thought to underlie the ability of many anaesthetic agents to induce immobility, independent of their amnesic and hypnotic properties.

7.1.2 The Effects of Anaesthetics on Large Scale Neuronal Activity

Because behavior emerges out of the cooperative activity of large populations of neurons it seems reasonable to expect anaesthetic agents to perturb macroscopic neural activity. The hypnotic and amnesic effects of anaesthetics are widely believed to be mediated by neuronal populations in the cerebrum, whereas the immobilizing and nociceptive effects of these agents are thought to arise as a consequence of the perturbation of neuronal populations of the dorsal and ventral horns of the spinal chord. A variety of neuroimaging techniques, which include the electroencephalogram (EEG) and functional magnetic resonance imaging (fMRI), have revealed that the activities of diverse ranges of cerebral neuronal populations are affected by anaesthetics (Franks 2008; Alkire et al. 2008). While the majority of positron-emission tomography (PET) and fMRI studies suggest non-uniform reductions in cerebral neuronal activity attend anaesthetic action, to date only changes in EEG activity have been reliably correlated with the clinically documented effects of anaesthesia.

During the progression to deep anaesthesia the EEG undergoes a series of well described quantitative changes. In general terms, increasing concentrations of the majority of anaesthetics slow the EEG (shift the spectral power towards low frequencies) and abolish the common features of resting EEG, such as the alpha rhythm (8–13 Hz). The arrival of deep anaesthesia is typically indicated by very slow isoelectric periods, which are often interleaved with short bursting activity, referred to as burst-suppression (Rampil 1998). Such quantitative features form the basis for many of the approaches that have been developed to measure anaesthetic depth based on the analysis of spontaneous EEG (Bruhn et al. 2000). While such features are not universal to all anaesthetic agents (xenon, nitrous oxide and ketamine—typically referred to as ‘dissociative’ agents—being clear exceptions), processed EEG data often correlate well with hypnotic and immobilizing endpoints.

Although a comparison between deep anaesthesia and the awake state shows a suppression of resting EEG power, the transition between these states is not necessarily continuous. The commencement of anaesthetic induction is often associated with a transient increase in total EEG power before the appearance of slow wave dominance. This phenomena is typically referred to as the ‘biphasic response’. Work by Kuizenga and colleagues (Kuizenga et al. 2001, 1998) has shown that an array of anaesthetic compounds produce band limited (2–5 and 11–15 Hz) power increases during the induction and emergence of anaesthesia. However, the biphasic response

during the emergent phase is often more pronounced than induction, although both are approximately coincident with the return and loss of consciousness, respectively. Some of these findings have been replicated more recently for propofol (Koskinen et al. 2005) and also for other frequency bands such as alpha (8–13 Hz) (Feshchenko et al. 2004). Finally, work by John et al. (2001) has previously suggested that EEG coherence is transiently enhanced just prior to loss of consciousness during anaesthesia, which inferentially coincides with the occurrence of the biphasic response.

To what extent these documented EEG effects are due to the direct cortical actions of anaesthetics or indirect subcortical ones (in particular the modulation of arousal and sleep pathways/systems) is at present unclear. However, as we will subsequently see the physiologically plausible modelling of electrocortical activity is expected to make important contributions to the resolution of this uncertainty.

7.1.3 From Ion Channels to EEG Through Mesoscopic Models

As argued above, sedative and hypnotic effects may be conceived as arising from the modulation of the activity of *populations* of cortical neurons. Of particular relevance are approaches that link non-invasively observable, and hence “macroscopic”, neural dynamics to the behavior of “microscopic” ion channels, whose activity is modulated by anaesthetic action, by modelling the intervening “mesoscopic” level of co-operative neuronal ensembles. Models of cortical activity formulated at this level are variously referred to as neural (mean) field or neural mass (action) theories, depending on whether a continuum approximation is invoked or not. A range of mesoscopic modelling approaches were developed early on (Amari 1975; Nunez 1974; Wilson and Cowan 1972, 1973), but it is those targeted at the EEG that are of most relevance (Deco et al. 2008; Liley et al. 2003, 2002, 1999; Robinson et al. 1997; Freeman 1975), since the EEG represents an inexpensive and readily available measure for cortical activity that is robustly affected by anaesthetic action.

While at the cellular and molecular level anaesthetics are generally characterized as being simple depressants of neuronal activity, their action in networks of interacting neuronal elements can be quite different. For example, anaesthetic and sedative agents that act cortically through the enhancement of GABAergic synaptic activity may enhance inhibitory synaptic activity terminating on inhibitory neurons to a greater extent than that terminating on excitatory neurons. In this case disinhibition, rather than suppression, of oscillatory EEG activity may occur contrary to expectations based on studies of single neurons. For example, the light-driven activation of fast-spiking interneurons² in rat barrel cortex *in vivo* at varying frequencies selectively amplifies gamma oscillations in the local field potentials of synaptically connected pyramidal neurons (Cardin et al. 2009). Such ‘paradoxical’ network effects

²This is achieved through the targeted expression, by the viral transfection, of a light-sensitive bacteriorhodopsin—a cation selective ion channel specifically activated by blue light.

may help explain the increase in total EEG power that often attends the induction of anaesthesia.

The small set of equations describing a neural mass is more amenable to analysis than networks of many individual model neurons, but can nevertheless retain a great deal of anatomical and physiological plausibility. The typical mesoscopic approach to EEG modelling consists of physiologically motivated, spatially coarse-grained equations describing the dynamics of excitatory and inhibitory neuronal populations. The resolution of the spatial coarse graining is generally chosen to match the scale of some aspect of cortical modularity, for example the cortical macrocolumn. Such models can be divided into *activity*- or *voltage*-based, depending on whether spatially averaged membrane potentials or firing rates, respectively, serve as state variables in the equations (Ermentout 1998). Usually, though not always, the dynamics of the mean soma membrane potential of excitatory neurons is the state variable taken to best represent the sources of the recorded EEG.

7.1.4 Chapter Outline

This chapter outlines the application of one particular mesoscopic theory of neural activity, that of Liley et al. (2003, 2002, 1999), to the characterization of the bulk electrocortical effects of anaesthetic and sedative agents. The chapter is divided into two major sections. The first section outlines the construction of the mean field model of Liley et al., its physiological parameter space, and the types of electro-physiologically plausible linear and nonlinear dynamics it is capable of producing. The second section describes how the mean field equations of this model can be parametrized to include a range of documented sub-cellular/molecular effects of anaesthetic and sedative agents. In particular, incorporating the dominant anaesthetic action of GABAergic agonism is able to account for a range of anaesthetic and sedative effects, which include alterations in the frequency spectrum of spontaneous EEG, and the ‘paradoxical’ ability of GAs to induce ictal activity. The chapter then concludes with a discussion of how the mean field formulation can be extended to model the effects of dissociative agents such as xenon and nitrous oxide, and how modelling anaesthetic action represents a cornerstone for understanding more generally the physiological principles that underpin the dynamics of brain function.

7.2 Mean Field Model

7.2.1 Overview

The thin rind of the cerebrum that comprises the cortex of mammals is densely populated with neurons. In a range of mammals from rats to humans it has been estimated that there are between 20,000 to 90,000 neurons per cubic millimetre of

cortical tissue, each of which receives of the order of 10,000 synaptic contacts from as many other cortical, and to a much lesser degree subcortical, neurons. Viewed from this perspective attempting to understand the dynamics of the resulting cortical networks would appear to require that each of the brain's 10^{10} – 10^{11} neurons and its 10^{14} – 10^{15} synaptic connections would need to be adequately characterized and modeled in order to understand the dynamics of brain activity, clearly an intractable task.

The mean field approach, originally arising out of mathematical models of ferromagnetism in statistical physics, provides a way forward. Here interactions between individual units are replaced by effective averages known as mean fields. The dynamics of the system is then approximated by the evolution of these mean fields. For a single cortical neuron a mean field could be formed by the mean activity of neurons from which it receives synaptic input. The spatial domain over which this synaptic input arises defines a mesoscopic neural mass. Formulations of mesoscopic neural dynamics that arise on the basis of this approach, while ignoring higher order correlations of individual neuronal activity, can nevertheless contribute greatly to our understanding of the dynamics of populations of neurons.

The current mathematical approach for formulating equations of motion for mesoscopic cortical neuronal dynamics principally stems from the work of Wilson and Cowan (1973, 1972), Nunez (1974) and Amari (1975). While these early models have been used for a range of biomathematical explorations, they have not been particularly successful in articulating the genesis of rhythmic activity in the EEG and its modulation by pharmacological agents. This can be attributed to a number of factors, the most important of which are mathematical simplifications not adequately justified by an appeal to the physiology. For example, both the models of Amari and Wilson and Cowan unrealistically assume that the effects of synaptic activity are felt instantaneously at the neuronal soma, whereas empirically these effects are known to steadily increase to a maximum on time scales depending on whether the synapse is excitatory or inhibitory and the passive electrical properties of neurons. This failure to incorporate known time scales of neurotransmitter action makes it impossible to include many of the well documented electrophysiological effects that anaesthetics have on cortical neurons and their synaptic interactions. Therefore physiologically more realistic mean field models are required to better understand the effects that anaesthetics have on bulk neural and hence electrocortical activity.

7.2.2 *The Liley et al. Model*

The model of Liley et al. (2003, 2002, 1999) provides a physiologically more accurate description of electrocortical activity. It can produce the main features of the spontaneous human EEG with a biologically plausible parametrization. The Liley et al. model identifies inhibitory synaptic activity as a particularly sensitive modulator of the EEG and hypothesizes that the important 8–13 Hz alpha rhythm emerges through reverberant oscillations between populations of inhibitory neurons. This

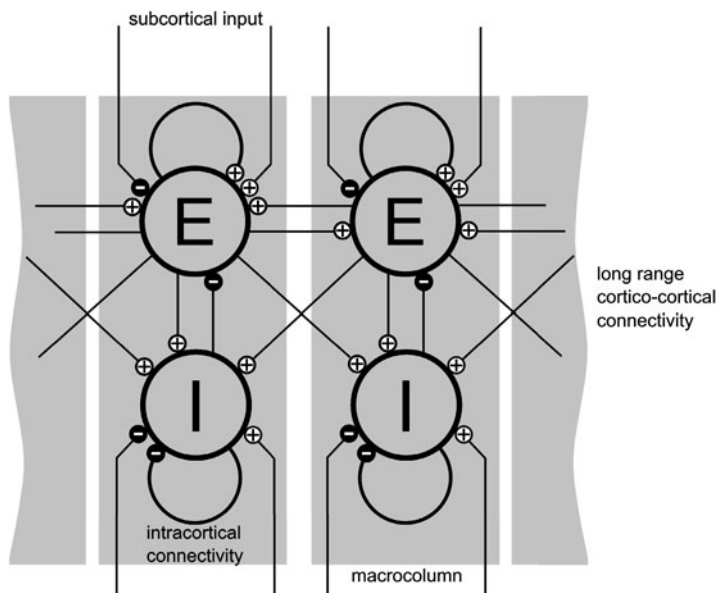

Fig. 7.1 Schematic overview of the essential intracortical and cortico-cortical interactions between excitatory and inhibitory neuronal populations in the model of Liley et al. (2003 2002, 1999)

theory is therefore well placed to account for the electrocortical effects of altered inhibitory activity that attends the action of the majority of GAs.

As is appropriate for a description of EEG data the model is spatially coarse grained over roughly the extent of a cortical macrocolumn. The multiple interactions between individual neuronal elements are replaced by effective interactions between the “mean fields” of populations of neurons. In contrast to for example the Wilson and Cowan equations, no averaging in time takes place. The essential components of the theory are schematically represented in Fig. 7.1, which depicts the interactions taking place within and between two different macrocolumns. The two functionally distinct types of cortical neuronal populations, excitatory (E) and inhibitory (I), subsume a much wider variety of dynamically and morphologically differentiated cortical neuronal subtypes. Within a cortical macrocolumn excitatory neurons (pyramidal and spiny stellate neurons) and inhibitory neurons (interneurons) interact with each other by all possible combinations of synaptic connections.

Cortical activity is here locally described by the mean soma membrane potentials of the spatially distributed excitatory neuronal population, h_e , and the inhibitory one, h_i . The connection with physiological measurement is through h_e , which is assumed to be linearly related to surface recorded EEG/ECOG (electrocorticogram) (Nunez 1981; Freeman 1975). Excitatory and inhibitory neuronal populations are modeled as single passive RC compartments into which all synaptically induced postsynaptic currents flow. Thus the response of the mean soma membrane potential

h_k with $k = e, i$ to induced postsynaptic activity I_{lk} is given by

$$\tau_k \frac{\partial h_k}{\partial t} = h_k^r - h_k(\mathbf{x}, t) + \sum_{l=e,i} \frac{h_{lk}^{eq} - h_k(\mathbf{x}, t)}{|h_{lk}^{eq} - h_k^r|} I_{lk}(\mathbf{x}, t), \quad (7.1)$$

where $\mathbf{x} \in \mathbb{R}^2$ is the position on the cortical sheet, h_k^r is the resting mean soma membrane potential and τ_k the mean membrane time constant. Double subscripts indicate first source and then target, e.g., I_{ei} indicates postsynaptic inputs from an excitatory to an inhibitory population. The synaptic inputs correspond to postsynaptic channel conductances and are weighted by ionic driving forces $h_{jk}^{eq} - h_k$, where the h_{jk}^{eq} are the respective *synaptic reversal potentials*. These weights are normalized to +1 (excitatory) and -1 (inhibitory), respectively, at the corresponding resting mean soma membrane potentials. This follows the *conductance* based approaches typically used to model networks of synaptically interacting networks of individual model neurons (Hines and Carnevale 2001; Bower and Beeman 1998).

The time course of the PSP is described by a critically damped oscillator driven by the mean rate of incoming excitatory or inhibitory axonal pulses. Thus for excitatory PSPs (EPSP) and inhibitory PSPs (IPSP) we have, respectively,

$$\left(\frac{1}{\gamma_{lk}} \frac{\partial}{\partial t} + 1 \right)^2 I_{lk}(\mathbf{x}, t) = \frac{\Gamma_{lk} e}{\gamma_{lk}} \cdot A_{lk}(\mathbf{x}, t), \quad (7.2)$$

$$A_{ek}(\mathbf{x}, t) = N_{ek}^\beta S_e[h_e(\mathbf{x}, t)] + \phi_{ek}(\mathbf{x}, t) + p_{ek}(\mathbf{x}, t),$$

$$A_{ik}(\mathbf{x}, t) = N_{ik}^\beta S_i[h_i(\mathbf{x}, t)], \quad (7.3)$$

where A_{lk} comprises different sources of incoming axonal pulses: $N_{lk}^\beta S_l$, the mean number of connections from local neuronal population l times their mean firing rate, models local inputs to target population k , p_{ek} represents extracortical (thalamic) excitatory sources and ϕ_{ek} pulses arriving across larger distances via the excitatory cortico-cortical fibre system. We have assumed here, according to current consensus, that subcortical input is dominated by excitatory projections to either excitatory or inhibitory cortical population, i.e., $p_{ik}(\mathbf{x}, t) \simeq 0$. For a *single* presynaptic spike $A_{lk}(t) = \delta(t)$, Equation (7.2) yields a normalized version of the well-known *synaptic alpha function* as postsynaptic response (Tuckwell 1988; van Rotterdam et al. 1982):

$$\text{PSP}_{lk}^\alpha(t; \gamma_{lk}) = \frac{\Gamma_{lk} e}{\gamma_{lk}} \cdot \underbrace{\gamma_{lk}^2 t \exp(-\gamma_{lk} t) \Theta(t)}_{\equiv \alpha(t; \gamma_{lk})}, \quad (7.4)$$

where Θ is the Heaviside function, Γ_{lk} is the mean PSP peak amplitude induced by a single presynaptic spike of type l in population k , and $1/\gamma_{lk}$ the corresponding rise time to this peak. PSP_{lk}^α 's are taken to describe the time course of 'fast' excitatory ($l = e$: α -amino-3-hydroxyl-5-methyl-4-isoxazole-propionate (AMPA) & kainate) and inhibitory ($l = i$: GABA_A) neurotransmitter kinetics.

Mean neuronal population firing rates are assumed to be an instantaneous function of the respective mean soma membrane potential. By requiring that mean firing rates increase monotonically with h_l and are bounded below by zero and above by a maximal firing rate S_l is defined to be a sigmoidal function of h_l , here parametrized by

$$S_l[h_l(\mathbf{x}, t)] = S_l^{\max} \cdot \left\{ 1 + \exp \left[\sqrt{2} \frac{h_l(\mathbf{x}, t) - \mu_l}{\sigma_l} \right] \right\}^{-1}. \quad (7.5)$$

The axonal pulses ϕ_{ek} are propagated by long-range cortico-cortical fibre systems having finite conduction delays. In the simplest case a single conduction velocity v_{ek} is assumed with an exponential fall off of the strength of connectivity with increasing distance between source and target populations with characteristic scale $1/\Lambda_{ek}$. In this case it can be shown (Liley et al. 2002) that ϕ_{ek} propagates approximately according to the following two-dimensional telegraph equation

$$\left[\left(\frac{1}{v_{ek} \Lambda_{ek}} \frac{\partial}{\partial t} + 1 \right)^2 - \frac{3}{2\Lambda_{ek}^2} \nabla^2 \right] \phi_{ek}(\mathbf{x}, t) = N_{ek}^{\alpha} S_e[h_e(\mathbf{x}, t)], \quad (7.6)$$

where N_{ek}^{α} is the total number of excitatory synaptic connections formed by long-range cortico-cortical axons on local population k . Robinson et al. (2001, 1997) and Jirsa and Haken (1996) have both used similar equations. Empirical measurements of conduction velocities suggest, however, that cortico-cortical conduction velocities are rather broadly distributed. On this basis Bojak and Liley (2010) have suggested an alternative propagator, which gives rise to realistic velocity distributions. While we will not pursue this question further here, it is interesting to note that “matching” (7.6) as well as possible to this new propagator, with parameters fitted to histopathological measurements of myelinated cortico-cortical fibres in human corpus callosum, suggest rather large $v_{ek} \gtrsim 7$ m/s.

Equations (7.1)–(7.6) typically define the model of Liley et al. (2003, 2002, 1999), and are capable of reproducing the main features of spontaneous human EEG. In what follows it will be convenient to rewrite these as a system of 14 coupled first order partial differential equations

$$\frac{\partial \mathbf{S}}{\partial t} = \mathbf{F}[\mathbf{S}] + \mathbf{P}, \quad (7.7)$$

$$\mathbf{S} = (h_e, h_i, I_{ee}, I_{ee}^{\text{aux}}, I_{ei}, I_{ei}^{\text{aux}}, I_{ei}, I_{ie}^{\text{aux}}, I_{ii}, I_{ii}^{\text{aux}}, \phi_{ee}, \phi_{ee}^{\text{aux}}, \phi_{ei}, \phi_{ei}^{\text{aux}})^{\text{T}}, \quad (7.8)$$

$$\mathbf{P} = (0, 0, 0, \hat{p}_{ee}, 0, \hat{p}_{ei}, 0, 0, 0, 0, 0, 0, 0, 0)^{\text{T}} \quad (7.9)$$

where all quantities depend on $\mathbf{x} \in \mathbb{R}^2$ and t , the \hat{p}_{ek} are proportional to spatiotemporal deviations from the (parametrized) mean values p_{ek} , and the auxiliary variables are the time derivatives $I_{ee}^{\text{aux}} \equiv \partial I_{ee} / \partial t$, etc. For further details see Bojak and Liley (2005). Table 7.1 summarizes the models parameters and their approximate physiological ranges.

Table 7.1 List of *spatially averaged* parameters for different types $k = e, i$ of neuronal target populations in the electrocortical model of Liley et al. (2003, 2002, 1999), with typical ranges that are assumed to be physiologically admissible. Table adapted from Bojak and Liley (2005)

	Definition	Min., Max.	Units
h_k^r	resting membrane potential	-80, -60	mV
τ_k	passive membrane decay time	5, 150	ms
h_{ek}^{eq}	excitatory reversal potential	-20, 10	mV
h_{ik}^{eq}	inhibitory reversal potential	-90, $h_k^r - 5$	mV
Γ_{ek}	EPSP peak amplitude	0.1, 2.0	mV
Γ_{ik}	IPSP peak amplitude	0.1, 2.0	mV
$1/\gamma_{ek}$	EPSP rise time to peak	1, 10	ms
$1/\gamma_{ik}$	IPSP rise time to peak	2, 100	ms
N_{ek}^α	no. of excitatory cortico-cortical synapses	$k=e$: 2000, 5000 $k=i$: 1000, 3000	-
N_{ek}^β	no. of excitatory intracortical synapses	2000, 5000	-
N_{ik}^β	no. of inhibitory intracortical synapses	100, 1000	-
v_{ek}	axonal conduction velocity	0.1, 1	$\frac{\text{mm}}{\text{ms}}$
$1/\Delta_{ek}$	decay scale of cortico-cortical connectivity	10, 100	mm
S_k^{max}	maximum firing rate	0.05, 0.5	ms^{-1}
μ_k	firing threshold	-55, -40	mV
σ_k	standard deviation of firing threshold	2, 7	mV
p_{ek}	extracortical synaptic input rate	0, 10	ms^{-1}

7.2.3 Linearization of the Model

Detailed semi-analytical and numerical solutions of (7.1)–(7.6) have revealed a rich repertoire of physiologically plausible dynamics. Of particular significance is the generation of noise driven, limit cycle and chaotic oscillations at the frequency of the mammalian alpha rhythm, with model parameters that are all within ranges reported experimentally (Bojak and Liley 2007, 2005; Liley et al. 2002, 1999; Dafilis et al. 2001). Because the state and parameter spaces of the defining equations are large and the system is highly nonlinear, understanding the relationship between particular parameters and the emergent dynamical states is difficult. Fortunately, many important predictions can be obtained by studying the simplified linear equations that arise from linearizing the original nonlinear partial differential equations about one or more time-invariant steady states. By expanding $\mathbf{F}[\mathbf{S}]$ of (7.7) about a time-invariant homogeneous steady state $\mathbf{F}[\mathbf{S}^*] = \mathbf{0}$, one obtains the following set of *linear* partial differential equations:

$$\frac{\partial \mathbf{s}}{\partial t} = \mathcal{J} \cdot \mathbf{s}(\mathbf{x}, t) + \mathbf{P}(\mathbf{x}, t), \quad (7.10)$$

where $\mathbf{s}(\mathbf{x}, t) \equiv \mathbf{S}(\mathbf{x}, t) - \mathbf{S}^*$, and \mathcal{J} is the Jacobian matrix of $\mathbf{F}[\mathbf{S}]$ evaluated at \mathbf{S}^* , i.e., $\mathcal{J} = \partial \mathbf{F}(\mathbf{S}) / \partial \mathbf{S}|_{\mathbf{S}=\mathbf{S}^*}$. For zero mean filtered noise input via \mathbf{P} , power spec-

tra of stable oscillatory components can be predicted rapidly by calculating the eigensystem of \mathcal{J} (Bojak and Liley 2005; Liley et al. 2002). Of particular relevance are those oscillations occurring in delta (0–4 Hz), theta (4–8 Hz), alpha (8–13 Hz) and beta (13–30 Hz) bands. The alpha rhythm is thus assumed here to arise from the filtering actions of cortex on a broad band stochastic input, a view that accords well with the results of attempts to characterize the dynamics of resting EEG (Jelezcov and Schwilden 2003; Schwilden and Jelezcov 2002; Stam et al. 1999).

This linearization also enables a semi-analytical determination of the sensitivity of the modeled oscillatory activity to parametric perturbation. One can write $\hat{h}_e(\mathbf{x}, t) \equiv h_e(\mathbf{x}, t) - h_e^*$, the first component of \mathbf{s} defined by (7.10), in transfer function form following Fourier transformation (Bojak and Liley 2005) as

$$\hat{h}_e(k, \omega) = G_e(k, \omega; \mathbf{S}^*, \mathbf{q}) \hat{p}_{ee}(k, \omega) = \frac{N(k, \omega; \mathbf{S}^*, \mathbf{q})}{D(k, \omega; \mathbf{S}^*, \mathbf{q})} \hat{p}_{ee}(k, \omega) \quad (7.11)$$

where \mathbf{q} is a vector collecting all model parameters, cf. Table 7.1, and G_e is the *electrocortical transfer function*, which can be separated into a numerator N and a denominator D . We have assumed for simplicity that spatiotemporal deviations from mean extracortical input occur only in p_{ee} , i.e., $\hat{p}_{ei}(\mathbf{x}, t) \simeq 0$. Furthermore, \hat{h}_e is only a function of the magnitude of the wave number $k = |\mathbf{k}|$, since the transfer function here contains only powers of \mathbf{k}^2 and we assume that the innovating extracortical input \hat{p}_{ee} is roughly isotropic. \mathbf{S}^* is a particular solution of $F(\mathbf{S})_{\mathbf{q}} = 0$, a solution which, however, can be specified by h_e^* alone. The sensitivity of the model's linear resonances (or poles) ω^* to a normalized parameter change $\hat{q}_j = (q_j - q_j^*)/q_j^*$, can then be calculated as (Bojak and Liley 2005)

$$\frac{\partial \omega^*}{\partial \hat{q}_j} = q_j^* \left(\frac{\partial D}{\partial h_e} \frac{\partial F}{\partial q_j} - \frac{\partial D}{\partial q_j} \frac{\partial F}{\partial h_e} \right) \bigg/ \left(\frac{\partial F}{\partial h_e} \frac{\partial D}{\partial \omega} \right) \bigg|_{h_e^*, \omega^*}, \quad (7.12)$$

where $\text{Re}[\partial \omega^* / \partial \hat{q}_j]$ and $-\text{Im}[\partial \omega^* / \partial \hat{q}_j]$ give the sensitivities of angular frequency and damping, respectively, to normalized parameter changes. It is found that parameters related to inhibitory-inhibitory interactions are the most sensitive determinants of the frequency and damping of emergent alpha band activity (Bojak and Liley 2005; Liley et al. 2003, 2002). As will be discussed in more detail below, sensitivity to inhibitory modulation appears to be central also for the effects that a range of sedative and anaesthetic agents have on the EEG (Bojak and Liley 2005).

7.2.4 Searching Parameter Space for Physiological Behavior

Mean field models are necessarily semi-heuristic in nature. While much of their structure can and should be motivated by anatomical and physiological considerations, they also intend to provide a very parsimonious description of a wide range of observed activity patterns. Hence one should not expect such models to match brain

dynamics of interest without any tuning of their parameters. We will consider this problem generally here, while illustrating the principle points with examples drawn from the description of anaesthesia suggested by Bojak and Liley (2005).

Assume that there exists some ideal theory $\mathbf{T}[\mathbf{x}, t; \mathbf{p}(\mathbf{x}, t)]$ with parameters \mathbf{p} and a state variable vector \mathbf{T} sufficient to characterize the phenomena of interest. The parameters \mathbf{p} should have some clear anatomical or physiological meaning, since then parameters obey biological constraints. In particular they can be bounded $\mathbf{p}^{\min} \leq \mathbf{p} \leq \mathbf{p}^{\max}$ by *independent* experimental measurements. Furthermore, only then will any parameter changes truly indicate that the corresponding biological substrates have changed.

A particular process of interest confines components of \mathbf{T} to a limited region of state space, often to particular trajectories. For example, for the alpha rhythm an “EEG variable” (h_e in the Liley model) must oscillate between low and high values with a period of about 0.1 seconds. A key expectation is then that dynamical confinement in state space is matched by a simple partitioning of parameter space. In our example one would hope to find a compact region of parameter space supporting the alpha rhythm, outside of which other dynamics reign. The size of such a region then is a measure of stability to natural variation within the biological substrate and to external disturbances.

Now consider some actual theory $\mathbf{S}[\mathbf{x}, t; \mathbf{q}(\mathbf{x}, t)]$, which we have invented. In general one expects that $\mathbf{S} \subset \mathbf{T}$ and $\mathbf{q} \subset \mathbf{p}$, i.e., one errs on the side of parsimony when building models. For example, perhaps modelling a dozen separate inhibitory populations would be ideal, but we have chosen to model only one for simplicity’s sake. One can now restrict some state variables to a process of interest, e.g., to the generation of an alpha rhythm. Thus for these state variables $[\mathbf{T}]_i \simeq [\mathbf{S}]_j$ by virtue of the fit. However, the mapping $[\mathbf{T}]_{k \neq i} \mapsto [\mathbf{S}]_{l \neq j}$ and $\mathbf{p} \mapsto \mathbf{q}$ is usually not one of (approximate) equality, indeed, generally it is neither linear nor reversible. To continue our example: tuning parameters so that the “EEG variable” produces an alpha rhythm for one and a dozen inhibitory populations, respectively, does not necessarily give the same results in other parts though the model structure may be more similar there. Thus unfortunately a simple “alpha region” in ideal parameter space can map to the actual parameter space in a complicated fashion.

When one fits the Liley model to produce “realistic alpha” activity, one indeed finds parameter distributions that lack simple regional structure. First let us briefly detail what we mean by “realistic alpha”: the goal is to generate a time series which resembles that of a human EEG recorded in a state of wakeful rest with eyes closed. Thus the power spectrum should show an overall “ $1/f$ ”-type decay plus a relatively sharp resonance at alpha frequencies (8–13 Hz). It is non-trivial to find selection criteria that allow a computer to evaluate whether a particular time series is suitable. We have proceeded by trial and error until all power spectra were rejected that we judged unacceptable. For example, one rule is that spectral power in the alpha band may not be more than five times as great as that in the delta band (0–4 Hz). We also require that the mean firing rate of the neuronal populations remains realistic, i.e., 0.1–20 pulses per second. For a detailed list of the other criteria see Bojak and Liley (2005).

Fig. 7.2 Smoothed histograms of some parameter distributions in the Liley model. Panels **A–C** (*left column*) show important PSP parameters as obtained for “realistic alpha” activity, panels **D–F** (*right column*) the same parameters under the influence of 2 MAC isoflurane, cf. Sect. 7.3.3. The *first row* (**A & D**) shows the peak amplitudes of inhibitory and excitatory PSPs averaged over the inhibitory neuron population. The *second row* (**B & E**) displays the corresponding PSP decay rates. The *third row* (**C & F**) exhibits derived quantities proportional to the total charge transferred by the PSPs, see text. Panel **C** shows the kind of parameter concentration one ideally expects, panel **F** suggests that isoflurane mostly increases inhibitory charge transfer

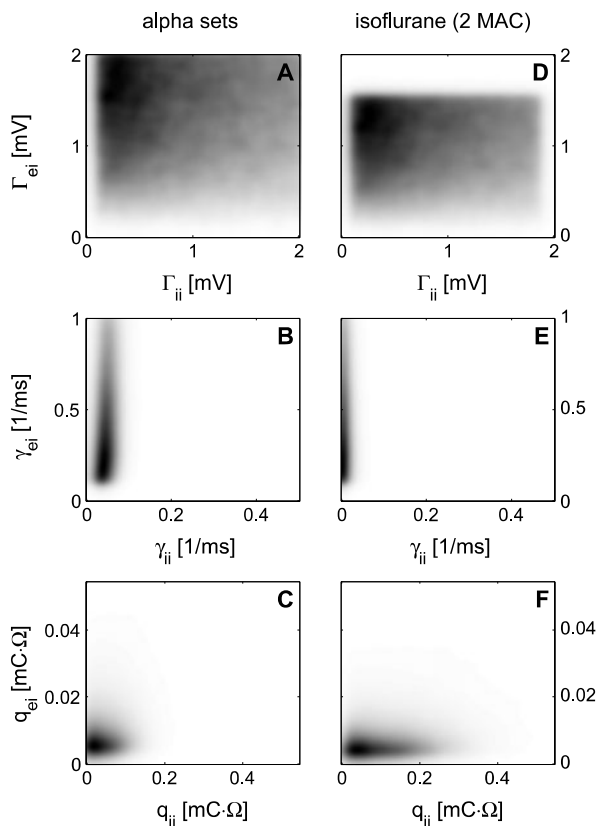

In the Liley model “realistic alpha” is widely distributed over the whole biologically valid parameter space without easily discernable structure in most parameter dimensions. Furthermore, “alpha sets” are relatively rare. We hence hypothesize that the unknown ideal theory has a simple but small “alpha parameter region” dispersed by mapping to the Liley model. This has immediate consequences. The generation of time series of sufficient length to produce smooth power spectrum estimates is relatively slow with a nonlinear model. Hence searching “alpha sets” with their unstructured and sparse parameter distribution is computationally demanding. In Bojak and Liley (2005) 27 such sets were nevertheless found, which *a posteriori* turned out to be described well by the linearization introduced above. The determination of power spectra by eigendecomposition of the Jacobian in (7.10) is several orders of magnitude faster than by direct nonlinear simulation. Hence by assuming that linearization is applicable in general a simple Monte Carlo scan of parameter space became feasible and 73,454 “realistic alpha” parameter sets were thereby found (Bojak and Liley 2005).

But can we trust results with actual parameters \mathbf{q} apparently dispersed compared to ideal parameters \mathbf{p} , even if the mapping remains within the biological ranges? For a first answer, consider Fig. 7.2A–C. Here we show the distribution of parameters

for all 73,454 sets found with the linearized Monte Carlo. The plots are made by selecting two parameters per panel, producing a two-dimensional histogram, which is smoothed (200 bins/axis, $\lambda = 10$) with the method of Eilers and Goeman (2004). Black color here corresponds to maximum frequency, white to no occurrence, and grey linearly to intermediate values. Upper limits as listed in Table 7.1 were used for the axes, lower limits were set to zero. In Fig. 7.2A we see the distribution of parameters for peaks amplitudes for excitatory Γ_{ei} and inhibitory Γ_{ii} PSPs in inhibitory neurons. While some preference for low Γ_{ii} and high Γ_{ei} is visible (maximum smoothed frequency is 4.38 out of 73,454 for the bin centred on $\Gamma_{ii} = 0.215$ mV and $\Gamma_{ei} = 1.555$ mV), we see that practically the entire allowed range supports alpha rhythms. A very different picture emerges for the corresponding decay rates γ_{ei} and γ_{ii} . While γ_{ei} is also spread out over the allowed range, with a weak trend to low values, γ_{ii} is concentrated strongly at low values (maximum 32.1 for $\gamma_{ii} = 0.04125$ /ms and $\gamma_{ei} = 0.1975$), with 99% of sets having a $\gamma_{ii} < 0.08627$ /ms. In (7.2) to (7.4) we have suggestively grouped the problematic Γ_{lk} parameters into combinations $q_{lk} \equiv \Gamma_{lk} \exp(1)/\gamma_{lk}$. As can be understood from (7.4), the q_{lk} correspond to the area under the PSP curves and hence are proportional to the total charge transferred. The distribution of q_{ei} and q_{ii} , see Fig. 7.2C, appears like the “alpha region” we would expect ideally (maximum 58.5 for $q_{ii} = 0.02039$ mC Ω and $q_{ei} = 0.005844$ mC Ω). Note that q_{ei} is computed from Γ_{ei} and γ_{ei} , both of which are distributed broadly. Yet the nonlinearity $1/\gamma_{ei}$ combines with the weak trends to produce a compact region. But choosing q_{lk} rather than Γ_{lk} as a parameter does not at all affect the validity of the theory as such. One can reasonably hope that a large part of the parameter dispersion is due to similar non-ideal but equivalent choices. We will return to this question in Sect. 7.3.3, where we will discuss the importance of extrinsic parameter changes in the context of GA effects.

7.3 Mesoscopic Modelling of Anaesthetic and Sedative Action

The range of molecular and cellular targets identified to date as sites of anaesthetic action is so varied that a unitary biological mechanism for anaesthetic effects seems unlikely. However, because these multiple sites of action result in a restricted range of functional disruptions (hypnosis, analgesia and immobility) modelling the effects of anaesthetics on neuronal activity should help to discover the underlying functional principles of anaesthetic action. The EEG is an essential measure of neuronal activity which is sensitively correlated with anaesthetic effect and hence can be used to study the dynamical, and by inference functional, effects of GAs. Table 7.2 illustrates that a number parameters in the Liley model can be related rather straightforwardly to identified sites of anaesthetic action in cortex.

7.3.1 Incorporating the Effects of Anaesthetic and Sedative Agents

Because the most dominant site of action for anaesthetic effect appears to involve inhibition, modelling the macroscopic dynamical effects of altered inhibition is a

Table 7.2 Relationship between major experimentally identified sites of cortical anaesthetic action and parameters of the electrocortical model of Liley et al. (2003, 2002, 1999)

Site of action	Main anaesthetic effect	Parameters
2PK channels & extrasynaptic GABA _A	increase in tonic inhibition	p_{ik}, h_k^r
nACh receptors	reduction in tonic excitation	p_{ek}, h_k^r
synaptic GABA _A	increase of IPSPs	γ_{ik}, Γ_{ik}
AMPA/kainate receptors & NMDA receptors ^a	reduction of EPSPs	γ_{ek}, Γ_{ek}
myelinated axons	slowdown of conduction ^b	v_{ek}
Na channels	alteration of neuronal firing	$S_k^{\max}, \mu_k, \sigma_k$

^aParameters will depend on membrane potential in this case

^bEffect demonstrated in periphery, speculative in cortex (Swindale 2003)

necessary step towards understanding anaesthetic action. Based on the parametrization of sufficiently detailed electrophysiological characterizations of the effects that benzodiazepines and the halogenated volatile agents have on inhibition, we show how the electrocortical model of Liley et al. (2003, 2002, 1999) can go some way to explaining how anaesthetic agents may modulate electroencephalographic activity.

7.3.2 The Benzodiazepine-Induced Beta-Buzz

Benzodiazepines are positive allosteric modulators of the GABA_A/benzodiazepine receptor complex. By inducing a conformational change, they increase the frequency of GABA initiated channel openings. Electrophysiologically, this increased probability of channel opening is reflected in an augmentation of the amplitude and the decay time of the associated unitary IPSP. Benzodiazepines have also been reported to increase single GABA_A channel conductances in the presence of low synaptic concentrations of GABA. Figure 7.3 illustrates how the amplitude of IPSPs, induced in rat hippocampal pyramidal (excitatory) neurons by nearby inhibitory basket cell interneurons, is augmented by the action of the benzodiazepine diazepam (Pawelzik et al. 1999). Electroencephalographically benzodiazepines are well known to decrease alpha (8–13 Hz) and increase low beta (13–16 Hz) activity in a dose dependent manner—the so-called “beta-buzz” (Hotz et al. 2000; Bertz et al. 1997; Breimer et al. 1990). However, despite careful and thorough characterizations of the molecular pharmacology of the benzodiazepines and their various electrophysiological effects, the mechanism whereby they induce changes in the spectral content of the EEG is unknown.

The simplest way of incorporating the action of benzodiazepines, such as diazepam, is to assume that they solely augment the amplitude of GABA mediated IPSPs, as schematically shown in Fig. 7.4. While benzodiazepines are also capable of altering the shape of the IPSP by prolonging their decay, we will defer incorporating and investigating such effects to our discussion of GAs below. Therefore for

Fig. 7.3 IPSPs induced in pyramidal neurons of rat hippocampus by nearby inhibitory basket cells are enhanced by the action of diazepam (1 μM). Panels **A** and **B** are taken with permission from Figs. 6 and 7, respectively, of Pawelzik et al. (1999). In this study, the amplitude of basket cell-induced IPSPs was principally increased with the shape (rise time, width at half amplitude) largely unaffected. Note that the lower panel shows the negative allosteric effects of Zn^{2+} on GABA_A mediated postsynaptic activity

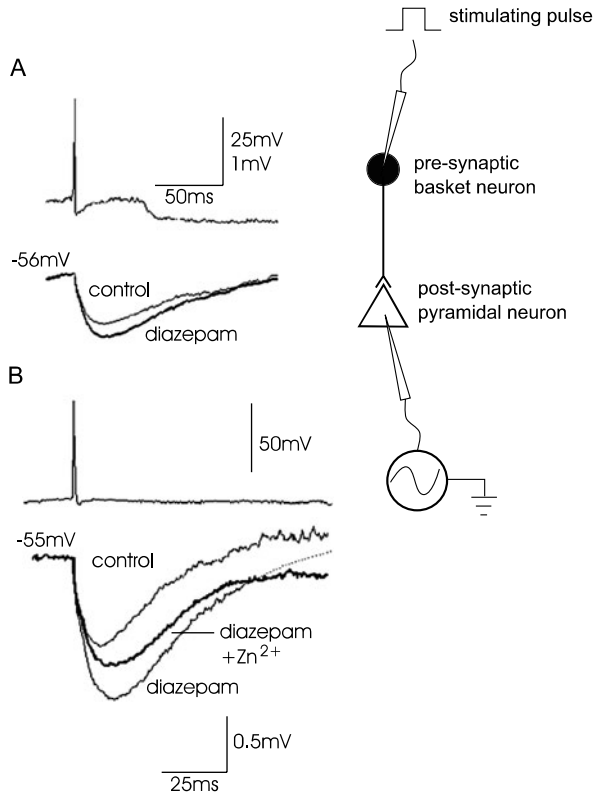

benzodiazepine action it is hypothesized that

$$\Delta\omega^* = \mu \left(\epsilon \frac{\partial\omega^*}{\partial\hat{\Gamma}_{ii}} + \frac{\partial\omega^*}{\partial\hat{\Gamma}_{ie}} \right) [\text{BZ}], \quad (7.13)$$

where μ and ϵ are real constants, [BZ] is the extracellular benzodiazepine concentration and $\Delta\omega^*$ (which will be complex) is the corresponding change in a dominant electroencephalographic resonance (specifically alpha) in the complex Fourier plane. Following Sect. 7.2.3, $\text{Re}[\partial\omega^*/\partial\hat{\Gamma}_{ii}]$ and $\text{Re}[\partial\omega^*/\partial\hat{\Gamma}_{ie}]$ represent the sensitivity of the alpha resonance frequency to unit normalized changes in the peak amplitude of IPSPs induced in inhibitory and excitatory neurons, respectively. Likewise, $-\text{Im}[\partial\omega^*/\partial\hat{\Gamma}_{ii}]$ and $-\text{Im}[\partial\omega^*/\partial\hat{\Gamma}_{ie}]$ represent the corresponding damping sensitivities. These are evaluated using (7.12) with a fixed k chosen to reflect the characteristic spatial scales of model and empirically recorded electrocortical activity.

Figure 7.5(A) qualitatively illustrates these as perturbations of a resting alpha resonance in the z -plane ($z = e^{i\omega/fs}$) based on the analysis of parameter sets found to give rise to electroencephalographically plausible activity in a physiologically admissible parameter domain (see Sect. 7.2.4 for further details). Therefore based

Fig. 7.4 A schematic diagram of benzodiazepine augmentation of the unitary IPSP amplitude induced by a presynaptic spike arriving at $t = 0$ in an excitatory neuron at rest. These IPSPs were numerically calculated with the model of Liley et al. (2003, 2002, 1999)

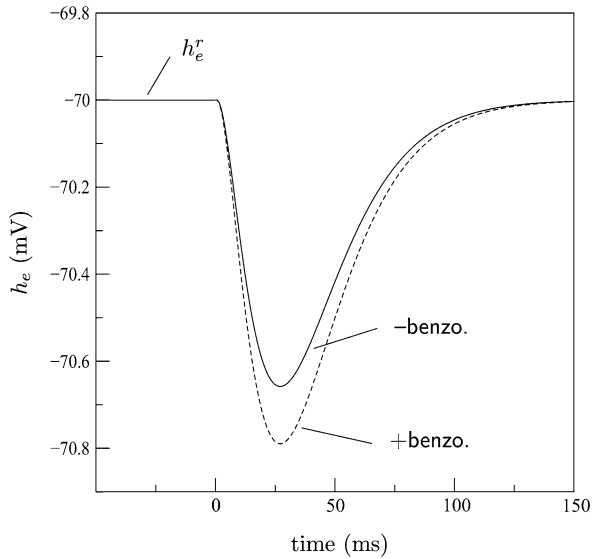

on empirically estimating $\Delta\omega^*$ in response to benzodiazepine actual estimates for ϵ and $\mu[\text{BZ}]$ can be found. Figure 7.5(B) illustrates estimates obtained for the location of the alpha resonance (pole) in the z -plane in a single participant before and 2 hours after the oral administration of a single 1 mg dose of the benzodiazepine alprazolam. It is clearly seen that the alpha pole, determined for each 2 s EEG epoch and estimated using a fixed order autoregressive moving average model derived from (7.11), has moved to higher frequencies and has become more damped. By calculating such pole motion over a number of participants, and by using (7.13) together with modeled pole sensitivities ϵ can be estimated. On this basis it is found that $\epsilon \approx 1.8$ (Liley et al. 2003), suggesting that alprazolam augments IPSPs induced in inhibitory neurons to a greater extent than those induced in excitatory neurons. This result accords well with the reported distribution of the high benzodiazepine affinity isoforms of the GABA_A receptor in inhibitory interneurons (Mohler et al. 1996).

In summary experimental EEG results analyzed in the context of the model of Liley et al. (2003, 2002, 1999) provide strong support for interpreting benzodiazepine-induced electroencephalographic changes as due to the parametrically selective modulation of a cortical white noise filter.

7.3.3 Accounting for the Spectral Changes in Inductive GA Action

For the inhaled GA isoflurane one experimentally finds the following dependence of PSPs on aqueous concentration c given in mM:

$$\Gamma_{ek}(c) \simeq \Gamma_{ek} \frac{0.707^{2.22}}{0.707^{2.22} + c^{2.22}}, \quad \Gamma_{ik}(c) \simeq \Gamma_{ek} \frac{0.79^{2.6} + 0.56c^{2.6}}{0.79^{2.6} + c^{2.6}}, \quad (7.14)$$

Fig. 7.5 (A) Schematic representation of the predicted effects of increasing the strength of neuronal population inhibitory-inhibitory and inhibitory-excitatory synaptic interactions assuming that scalp EEG activity has a fixed characteristic physical scale. The *filled circle* approximately represents the theoretical loci of the dominant poles associated with electroencephalographically plausible eyes-closed alpha activity. The *arrows* indicate the mean predicted direction of motion of these poles in response to increases in peak IPSP amplitudes Γ_{ii} and Γ_{ie} as per (7.13). For illustrative purposes indicated changes are not to scale. (B) Example of fixed ARMA model estimation of alpha pole location in the z -plane before and 2 hours after the 1 mg oral administration of the benzodiazepine (BZ) alprazolam. Each cross represents the pole estimated from a different 2 s epoch of the respective 66 s EEG recording. The *grey arrow* indicates the direction of median pole motion. Figure adapted from Liley et al. (2003)

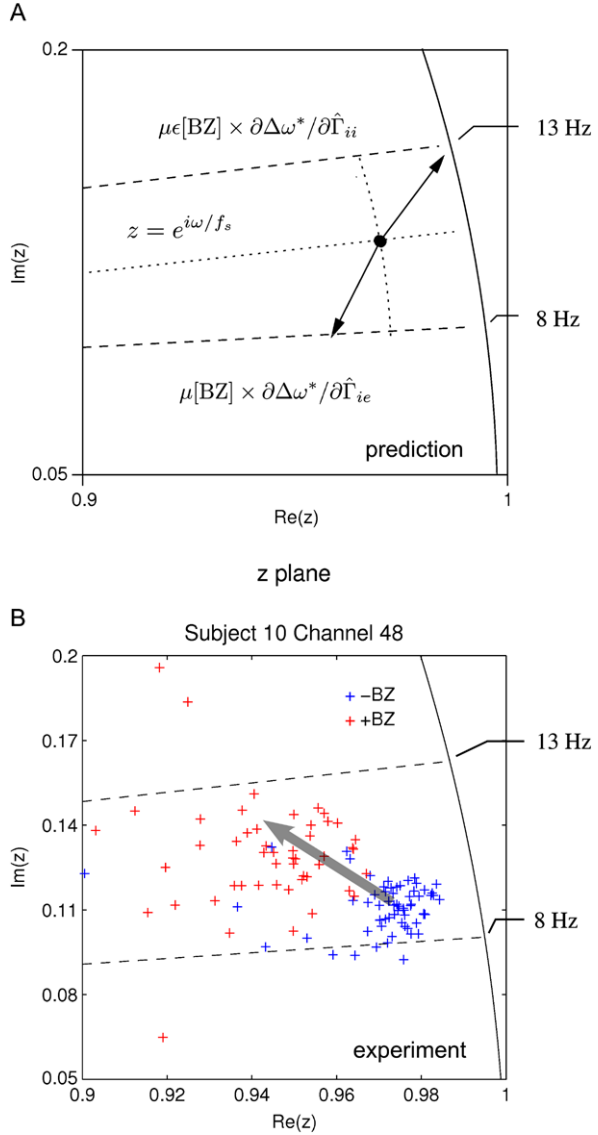

$$\delta_{ek}(c) \simeq \delta_{ek}, \quad \delta_{ik}(c) \simeq \delta_{ik}, \quad (7.15)$$

$$\zeta_{ek}(c) \simeq \zeta_{ek}, \quad \zeta_{ik}(c) \simeq \zeta_{ik} \frac{0.32^{2.7} + 4.7c^{2.7}}{0.32^{2.7} + c^{2.7}}, \quad (7.16)$$

where Γ_{lk} is the peak amplitude of the PSP, δ_{lk} the time needed to reach this peak after the incoming pulse, and ζ_{ek} the time after the presynaptic spike by which the PSP has fallen to Γ_{lk}/e again. See Bojak and Liley (2005) and references therein for a detailed discussion of these Hill equations. In clinical practice one often en-

counters as practical measure the *minimum alveolar concentration* (MAC) of gas required to abolish the response to pain in 50% of (adult) subjects. We will use here 1 MAC = 1.17 vol% = 0.243 mM for isoflurane. During surgery a typical maintenance dose for isoflurane is between 0.9 and 3 MAC, depending among other things on whether additional drugs are given or not. This provides a practical range of interest for c here.

Solving (7.4) for the time to peak δ^α , i.e., $\text{PSP}^\alpha(t = \delta^\alpha) = \Gamma$, and the characteristic decay time ζ^α , i.e., $\text{PSP}^\alpha(t = \zeta^\alpha) = \Gamma/e$ with $\zeta^\alpha > \delta^\alpha$, yields:

$$\delta^\alpha = \frac{1}{\gamma}, \quad \zeta^\alpha = w\delta^\alpha, \quad (7.17)$$

where $w \equiv -W_{-1}(-\frac{1}{e^2}) \simeq 3.1462$ with W_{-1} the -1^{st} branch of the Lambert-W function, and we suppress indices lk here and in the following. Clearly increasing ζ^α then requires increasing δ^α , i.e., the synaptic alpha function model of the PSPs cannot keep their rise times roughly constant while significantly prolonging their decays. As seen above this is at odds with the experimental situation for IPSPs under the influence of isoflurane.

A simple extension of the synaptic alpha function, which allows independent adjustments of rise and decay times, is the bi-exponential form:

$$\beta(t; \gamma, \tilde{\gamma}) = \gamma\tilde{\gamma} \frac{\exp(-\gamma t) - \exp(-\tilde{\gamma} t)}{\tilde{\gamma} - \gamma} \Theta(t). \quad (7.18)$$

Note that the bi-exponential form is invariant under the exchange of decay rates $\tilde{\gamma} \leftrightarrow \gamma$ and has the following interesting parametric limit:

$$\lim_{\tilde{\gamma} \rightarrow \gamma} \beta(t; \tilde{\gamma}, \gamma) = \alpha(t; \gamma) \quad \Rightarrow \quad \beta(t; \tilde{\gamma} = \gamma, \gamma) \equiv \alpha(t; \gamma), \quad (7.19)$$

i.e., the bi-exponential form becomes the synaptic alpha function for equal decay rates. Actually, this limit is a *removable discontinuity*, where as indicated we define the value at $\tilde{\gamma} = \gamma$ to be continuous. For the bi-exponential rise times one finds

$$\delta^\beta = \frac{\log(\tilde{\gamma}/\gamma)}{\tilde{\gamma} - \gamma}, \quad \lim_{\tilde{\gamma} \rightarrow \gamma} \delta^\beta = 1/\gamma = \delta^\alpha. \quad (7.20)$$

The time to peak is a convenient quantity, since it can be measured easily in experiments. It hence makes sense to require $\delta^\beta = \delta^\alpha = \delta$, by re-parametrizing $\beta(t; \tilde{\gamma}, \gamma)$ as a family of functions with rise time δ that includes $\alpha(t; \gamma)$ as a limit case. To simplify solving (7.20) for the rates, define an auxiliary parameter ϵ :

$$\epsilon \equiv \log \frac{\tilde{\gamma}}{\gamma} \quad \Rightarrow \quad \delta = \frac{\epsilon}{\tilde{\gamma} - \gamma}. \quad (7.21)$$

Then one finds for the decay rates

$$\tilde{\gamma} = \exp(\epsilon)\gamma, \quad \gamma = \frac{\epsilon}{\exp(\epsilon) - 1} \frac{1}{\delta} \quad \Rightarrow \quad \gamma|_{\epsilon=0} \equiv \frac{1}{\delta} \equiv \tilde{\gamma}|_{\epsilon=0}. \quad (7.22)$$

Note that for $\epsilon \rightarrow 0$, which means $\tilde{\gamma} \rightarrow \gamma$, we now find the removable discontinuity in $\tilde{\gamma}$ and γ . We will consequently also define them as continuous with the limit.

Using these decay rates, one can show that $\beta(t = \delta; \tilde{\gamma}, \gamma) = \tilde{\gamma} \exp(-\tilde{\gamma}\delta) = \gamma \exp(-\gamma\delta)$. This leads us to define the following bi-exponential PSP, with indices for the sake of definiteness:

$$\text{PSP}_{lk}^{\beta}(t; \delta_{lk}, \epsilon_{lk}) = \frac{\Gamma_{lk} \exp(\gamma_{lk} \delta_{lk})}{\gamma_{lk}} \cdot \underbrace{\gamma_{lk} \tilde{\gamma}_{lk} \frac{\exp(-\gamma_{lk} t) - \exp(-\tilde{\gamma}_{lk} t)}{\tilde{\gamma}_{lk} - \gamma_{lk}}}_{\equiv \beta(t; \delta_{lk}, \epsilon_{lk})} \Theta(t), \quad (7.23)$$

where γ_{lk} and $\tilde{\gamma}_{lk}$ depend on δ_{lk} and ϵ_{lk} as per (7.22). This form remains invariant against $\epsilon_{lk} \rightarrow -\epsilon_{lk}$ ($\gamma \leftrightarrow \tilde{\gamma}$) and we use $\epsilon_{lk} \geq 0$ without loss of generality. One finds that $\text{PSP}_{lk}^{\beta}(t; \delta_{lk}, \epsilon_{lk}) \geq \text{PSP}_{lk}^{\alpha}(t; \gamma_{lk})$, with equality only for $t = 0$, δ_{lk} , and ∞ . We can now also write the appropriate PDE for this pulse response, cf. (7.2):

$$\left(\frac{1}{\tilde{\gamma}_{lk}} \frac{\partial}{\partial t} + 1 \right) \left(\frac{1}{\gamma_{lk}} \frac{\partial}{\partial t} + 1 \right) I_{lk}(\mathbf{x}, t) = \frac{\Gamma_{lk} \exp(\gamma_{lk} \delta_{lk})}{\gamma_{lk}} \cdot A_{lk}(\mathbf{x}, t). \quad (7.24)$$

Note finally that the area under the PSP curves (\sim total charge transferred) has now become $q_{lk} = \Gamma_{lk} \exp(\gamma_{lk} \delta_{lk}) / \gamma_{lk}$.

What is the characteristic decay time $\text{PSP}^{\beta}(t = \zeta; \delta, \epsilon) = \Gamma/e$ with $\zeta > \delta$? Defining $r \equiv \zeta/\delta$, one can find analytic results only for particular limits:

$$\epsilon \ll 1: \quad r \simeq w \left[1 + \frac{\epsilon^2}{24} (w-1) \right], \quad \epsilon \simeq \sqrt{\frac{24(r/w-1)}{w-1}}, \quad (7.25)$$

$$\epsilon \gg 1: \quad r \simeq 1 + \frac{\exp(\epsilon)}{\epsilon}, \quad \epsilon \simeq -W_{-1} \left(\frac{1}{1-r} \right). \quad (7.26)$$

Now consider the following procedure: at zero isoflurane concentration $c = 0$ we fit the model parameters using a synaptic alpha function (i.e., the $\epsilon = 0$ bi-exponential form). This yields $r_0 = \zeta_0/\delta = w$, which is the fastest decay for a specified δ . If one measure a larger $\zeta(c)$ and thus larger $r(c) = \zeta(c)/\delta(c) \simeq \zeta(c)/\delta$, how large must $\epsilon(c)$ become to obtain this $r(c)$? Defining $\kappa(c) \equiv r(c)/r_0 = \zeta(c)/\zeta_0$, an approximate answer with better than 1% accuracy is given by

$$\epsilon \simeq e^{2.5466 - 1.3394\kappa} \sqrt{\kappa - 1} + \left[e^{-1.2699(\kappa-1)} - 1 \right] \left[\frac{1}{\kappa^2} + W_{-1} \left(\frac{e^{-\frac{0.23630}{\kappa^2}}}{1 - 3.1462\kappa} \right) \right]. \quad (7.27)$$

Of course, one can also solve for $\epsilon(c)$ numerically to obtain better precision.

The ratio $\kappa(c)$ is given by (7.16), and together with (7.14) and (7.15) this fully specifies the effect of isoflurane on the bi-exponential PSPs. In Fig. 7.2D–F we show smoothed histograms of the PSP parameters of the inhibitory target population for 2 MAC isoflurane, using the “realistic alpha” activity parameters of Fig. 7.2A–C as the basis at $\epsilon = 0$. Comparing Fig. 7.2A and D, we see that the both excitatory and inhibitory peak amplitudes are reduced with anaesthesia, but the former

faster than the latter. Panels B and E of Fig. 7.2 show that only the inhibitory decay rates decrease, while the excitatory ones remain constant. Of course, the rise times are assumed as constant as well and are not shown here. Finally, Fig. 7.2C and F demonstrate that isoflurane increases significantly the charge transfer from inhibitory sources, whereas that of excitatory one is slightly diminished.

What is the dynamical effect of these parametric changes plus the corresponding ones for the excitatory target population (not shown in Fig. 7.2)? We can easily generate predictions of the power spectral density (PSD) for all 73,454 sets at 0, 1, and 2 MAC using the eigendecomposition approach, see Bojak and Liley (2005) for details. However, it is difficult to display the full variability of these results: the PSDs differ not only in the shape, but also considerably in total power (area under the PSD curve) and location of the alpha resonance (8 to 13 Hz). Hence we perform two transformations: First, we norm the total power at 0 MAC to one. Second, we scale frequencies so that at 0 MAC the peak of the alpha resonance always occurs at $f = 11.03$ Hz, the mean alpha peak frequency over all 73,454 sets. Next we compute PSD quantiles from 4.5% to 95.5% in steps of 1% for all frequencies and plot these steps as bands in frequency each with a greyscale color, where the 49.5% to 50.5% (median) band is colored black and the other bands linearly lighter according to the difference from median.

We repeat this procedure for 1 MAC and 2 MAC isoflurane, but we use the same 0 MAC total power norm and alpha frequency scaling on a set-by-set basis. Finally, we add constants to all PSD values for 0 MAC and 1 MAC, in order to separate the bands along the ordinate. The resulting Fig. 7.6 shows the considerable variation of alpha peak and “ $1/f$ ” amplitude, respectively, possible at 0 MAC for different parameters. Nevertheless, these variations all look quite natural for human EEG. The PSDs for 1 MAC and 2 MAC show that the former alpha peak moves to lower frequencies while at the same time becoming broader. The “ $1/f$ ” part at lower frequencies is less affected. Significantly, the PSDs do not “wash out” for the induction with isoflurane, as one would expect if there was a large variation in the dynamic responses of different parameter sets to the GA-induced parameter changes. Instead there occurs a largely stereotypical response, which keeps the quantile bands at non-zero concentration roughly as spread out around the median as for 0 MAC. Overall then, we obtain very stable predictions well compatible with known changes of the EEG under anaesthesia.

We briefly return to our discussion of ideal and actual theories from Sect. 7.2.4. In the current subsection we have discussed a particular case of *extrinsic* parameter change, impressed on “realistic alpha” parameter sets to model induction with isoflurane. Consider now in general the procedure of varying some of the parameters $[\mathbf{q}]_n(c)$ of the actual model according to some extrinsic control parameter c , where we can assume without loss of generality that larger c causes “greater effect” in some sense, and a baseline fit of parameters was performed at $c = 0$ (the “normal” state). Now as parameters $[\mathbf{q}]_n(c)$ change with c , one can check whether the predicted model state $[\mathbf{S}]_i(c)$ continues to match the corresponding data *without* adjusting the parameters not under extrinsic control $[\mathbf{q}]_{m \neq n}(c) = [\mathbf{q}]_{m \neq n}(c = 0)$. If so, then this provides evidence that the mechanistic explanation provided by the actual theory \mathbf{S} is valid at least in an effective sense. In our case here we have shown

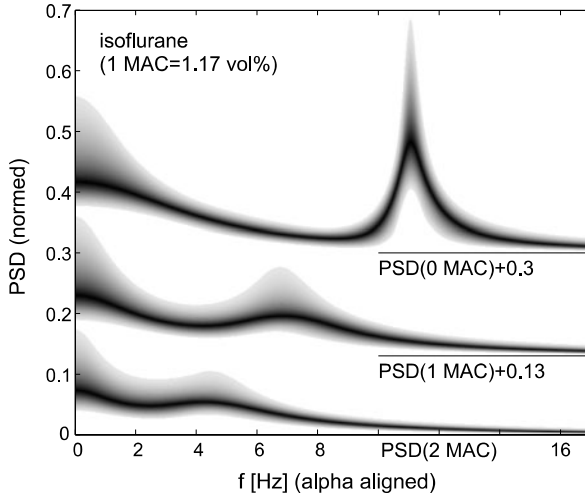

Fig. 7.6 Distribution of predicted power spectral densities (PSDs) for 73,454 “realistic alpha” parameter sets, and its change under induction with isoflurane. The variability in predicted total power and alpha peak location has been suppressed here, see text. In order to separate the different stages of anaesthesia visually, PSDs for 0 MAC and 1 MAC have been shifted up along the ordinate with fixed offsets (0.3 and 0.13, respectively), as indicated by *horizontal lines* from 9 to 17 Hz showing the corresponding zero baseline

that changing the bi-exponential PSP parameters alone will lead to spectral changes compatible with observations from human EEG under anaesthesia.

Of course, the unknown ideal theory must agree with the actual one where the latter predicts correctly: $[S]_i(c) \simeq [T]_j(c)$. Furthermore, parameters of similar nature must be changed in like manner in both theories: $[p]_k(c) \rightsquigarrow [q]_n(c)$. Here we have changed PSP parameters according to experimental data for isoflurane in the Liley et al. model. But these effects would have to be incorporated rather similarly in the ideal theory, simply because these changes are real. However, in the ideal theory such changes would perhaps differentiate across a dozen inhibitory populations, whereas we have considered only one here. In the actual theory the parameter changes *cause* the wanted state change, as confirmed by computing the predictions. In the ideal theory, some other mechanism could be responsible, with the change of $[p]_k(c)$ only being accidental. However, this becomes more unlikely the greater the precision and stability of the actual model predictions, since parts of the ideal theory would then have to conspire for all variations of c . By forcing the system extrinsically onto some trajectory through parameter space, which is required to produce a specific trajectory in observed state space, we hence gain considerable confidence in the relevant part of the actual model. Given our good and stable results here for modelling isoflurane effects through PSP changes, it hence appears likely that this mechanism at least contributes significantly in reality. Furthermore, the PSP description appears sufficiently accurate in the current Liley theory and the remaining parameter dispersion is likely due to other parts of the model.

7.4 Conclusion

In recent years considerable progress has been made in identifying the targets and mechanisms of anaesthetic drug action in the central nervous system. Such improvements in identifying and characterizing the effects of anaesthetic agents, primarily upon neuronal transmembrane ionotropic receptor proteins, suggests a variety of postsynaptic targets as well as receptor subunit selectivity across anaesthetics. What remains to be elucidated is the consequences of this cellular and molecular diversity upon EEG recorded from humans to observe and monitor such effects on behavior. Above we have presented a theoretical approach, based on the work of Liley et al., which attempts to connect the known cellular actions of anaesthetic agents with their effects on the EEG through an intervening mesoscopic mean field theory. Whilst the construction of these models incurs some exclusion of microscopic neural elements, such reductions allow detailed analysis and simulation which reproduce many of the features of resting EEG activity and its modulation by anaesthetics. Furthermore these simulations at the mesoscopic scale also replicate EEG activities observed during anaesthesia, such as the biphasic response, which are not observed at the lower level sites of action. From these developments, future advances can be made by enhancing the biological plausibility of modeled electrocortical activity, not only through constrained parameter set selection as discussed, but also through improvements in physiological and anatomical detail.

As noted in Table 7.2 a large number of existing model parameters in the Liley et al. theory can be modified as a possible means to capturing the effects of anaesthetics, or other neuromodulators, at sites other than fast inhibitory GABAergic synapses. Of particular future interest is the exploration of parametric changes in excitatory neurotransmission, in particular its reduction as induced by the dissociative anaesthetics such as nitrous oxide, ketamine and xenon. These agents all appear to reduce excitatory neurotransmission chiefly through antagonism of NMDA receptor currents, which contribute to the 'late' component of the glutamatergic EPSP. Whilst existing model parameters may capture such effects, developments can be made to better allow the inclusion of voltage sensitive 'slow' postsynaptic effects (NMDA) into existing 'fast' synaptic activities (AMPA). Such improvements will assist in understanding the often paradoxical effects of dissociative agents on the EEG, such as preservation of alert-like desynchronized activity and the subsequent insensitivity of many commercial processed EEG monitors during dissociative anaesthesia. Furthermore, the modelling of sole agent effects is at odds with the common admixture of anaesthetic agents (adjuvants), thus improvements in modelling multiple sites of action outside the dominant inhibitory or excitatory synaptic targets will help bring such theoretical advances closer to the clinical setting.

This chapter has aimed to provide a comprehensive exposition of one particular mesoscopic theory of general anaesthetic action. However, it has only discussed the ability of this theory to describe, and putatively explain, the well-known stereotypical effects of anaesthetics in altering the spectral features of EEG—the initial 'beta' buzz and the subsequent reduction in mean frequency with increasing anaesthetic concentration. But a variety of neuroimaging studies have revealed that

anaesthetics give rise to topographically non-uniform changes in cortical and sub-cortical activity (Franks 2008; Alkire et al. 2008). Among the best documented of such changes involve reductions in regional cerebral blood flow in the precuneus and posterior cingulate cortex (parietal cortex) and the orbitofrontal and anterior cingulate cortices (frontal cortex). Significant changes in topographic electroencephalographic activity while also seen, are spatially much coarser: reductions in posterior (occipital) alpha power, increases in frontal/central beta power and changes in areal coupling (based on calculating inter-hemispheric coherence) (John et al. 2001; Gugino et al. 2001).

Because these and other changes have been interpreted as signaling that anaesthetic-induced loss of consciousness is associated with a breakdown of cortical connectivity, it is important that mean field theories of the type outlined in this chapter are studied in the context of more realistic cortical geometries and connectivities. While there are many challenges to achieving this, not least the empirical specification of cortico-cortical connectivity, recent progress has been made by Bojak et al. (2010) in configuring mean field theories to realistic cortical geometries extracted from structural MR images which incorporate structural synaptic connectivity based upon *ex vivo* tract-tracing experiments or *in vivo* diffusion MR tractography. Furthermore, because this approach enables the simultaneous prediction of both the scalp recorded EEG and fMRI BOLD signals from simulated activity it will aid in theoretically unifying a range of empirical data relevant to better understanding anaesthetic action.

In addition to mean field theories providing an attractive framework with which to model the bulk effects that anaesthetic agents on brain activity, they also offer the possibility of inspiring better approaches to characterizing and analyzing such activity. While the mesoscopic mean field theory that we have outlined here is mathematically elaborate, it does suggest, to first approximation, that the resting electroencephalogram may be regarded as a filtered pseudorandom linear process. Specifically it posits that the electroencephalogram arises from cortex linearly filtering subcortical (thalamic) input, see Sect. 7.2.3, in particular (7.11). The direct empirical consequence of this is that the electroencephalogram can be modeled as a fixed order autoregressive moving average (ARMA) process (Liley et al. 2008). Then the estimated ARMA coefficients characterize the properties of the “cortical filter”, whereas the estimated amplitude of the white noise driving corresponds to the assumed magnitude of the subcortical (thalamic) input. When such a method of analysis is applied to real EEG it is found that the effects a synthetic opioid (remifentanyl) and a well-known hypnotic (propofol) have on frontally recorded EEG activity can be quite clearly differentiated (Liley et al. 2010). It is found that the hypnotic agent perturbs the state of the cortical filter whereas the opioid alters the assumed magnitude of subcortical input. Such differentiation of effects is currently not possible using other electroencephalographic monitoring approaches, such as the bispectral index and the various entropy indices, but clearly of great importance for understanding the action of distinct pharmacological agents on brain activity.

References

- Alkire MT, Hudetz AG, Tononi G (2008) Consciousness and anesthesia. *Science* 322:876–880
- Amari S (1975) Homogeneous nets of neuron-like elements. *Biol Cybern* 17:211–220
- Bayliss DA, Barrett PQ (2008) Emerging roles for two-pore-domain potassium channels and their potential therapeutic impact. *Trends Pharmacol Sci* 29:566–575
- Belelli D, Harrison NL, Maguire J, Macdonald RL, Walker MC, Cope DW (2009) Extrasynaptic GABAA receptors: form, pharmacology, and function. *J Neurosci* 29(41):12757–12763
- Bertz RJ, Kroboth PD, Kroboth FJ, Reynolds IJ, Salek F, Wright CE, Smith RB (1997) Alprazolam in young and elderly men: sensitivity and tolerance to psychomotor, sedative and memory effects. *J Pharmacol Exp Ther* 281:1317–1329
- Bojak I, Liley DTJ (2005) Modeling the effects of anesthesia on the electroencephalogram. *Phys Rev E* 71:041902
- Bojak I, Liley DTJ (2007) Self-organized 40 Hz synchronization in a physiological theory of EEG. *Neurocomputing* 70:2085–2090
- Bojak I, Liley DTJ (2010) Axonal velocity distributions in neural field equations. *PLoS Comput Biol* 6(1):e1000653
- Bojak I, Oostendorp TF, Reid AT, Kotter R (2010) Connecting mean field models of neural activity to EEG and fMRI data. *Brain Topogr* 23:139–149
- Bower J, Beeman D (1998) *The book of GENESIS: exploring realistic neural models with the GEneral NEural SIMulation system*, 2nd edn. Springer, New York
- Breimer LT, Hennis PJ, Burm AG, Danhof M, Bovill JG, Spierdijk J, Vletter AA (1990) Quantification of the EEG effect of midazolam by aperiodic analysis in volunteers. *Pharmacokinetic-pharmacodynamic modelling*. *Clin Pharmacokinet* 18:245–253
- Bruhn J, Bouillon T, Shafer S (2000) Bispectral index (BIS) and burst suppression: revealing a part of the bis algorithm. *J Clin Monit Comput* 16:593–596
- Campagna JA, Miller KW, Forman SA (2003) Mechanisms of actions of inhaled anesthetics. *N Engl J Med* 348:2110–2124
- Cantor RS (1997) The lateral pressure profile in membranes: a physical mechanism of general anesthesia. *Biochemistry* 36:2339–2344
- Cardin JA, Carlen M, Meletis K, Knoblich U, Zhang F, Deisseroth K, Tsai LH, Moore CI (2009) Driving fast-spiking cells induces gamma rhythm and controls sensory responses. *Nature* 459:663–667
- Dafilis MP, Liley DTJ, Cadusch PJ (2001) Robust chaos in a model of the electroencephalogram: implications for brain dynamics. *Chaos* 11:474–478
- Deco G, Jirsa VK, Robinson PA, Breakspear M, Friston K (2008) The dynamic brain: from spiking neurons to neural masses and cortical fields. *PLoS Comput Biol* 4(8):e1000092
- Eger EE, Raines DE, Shafer SL, Hemmings HC, Sonner JM (2008) Is a new paradigm needed to explain how inhaled anesthetics produce immobility? *Anesth Analg* 107:832–848
- Eilers PHC, Goeman JJ (2004) Enhancing scatterplots with smoothed densities. *Bioinformatics* 20:623–628
- Ermentout B (1998) Neural networks as spatio-temporal pattern-forming systems. *Rep Prog Phys* 61:353–430
- Feshchenko VA, Veselis RA, Reinsel RA (2004) Propofol-induced alpha rhythm. *Neuropsychobiology* 50(3):257–266
- Franks NP (2008) General anaesthesia: from molecular targets to neuronal pathways of sleep and arousal. *Nat Rev Neurosci* 9:370–386
- Franks NP, Lieb WR (1994) Molecular and cellular mechanisms of general anaesthesia. *Nature* 367:607–614
- Freeman WJ (1975) *Mass action in the nervous system*. Academic Press, New York
- Grasshoff C, Rudolph U, Antkowiak B (2005) Molecular and systemic mechanisms of general anaesthesia: the ‘multi-site and multiple mechanisms’ concept. *Curr Op Anaesthesiol* 18(4):386–391

- Gugino LD, Chabot RJ, Prichep LS, John ER, Formanek V, Aglio LS (2001) Quantitative EEG changes associated with loss and return of consciousness in healthy adult volunteers anaesthetized with propofol or sevoflurane. *Br J Anaesth* 87:421–428
- Hemmings HC, Akabas MH, Goldstein PA, Trudell JR, Orser BA, Harrison NL (2005) Emerging molecular mechanisms of general anesthetic action. *Trends Pharmacol Sci* 26(10):503–511
- Hines ML, Carnevale NT (2001) NEURON: a tool for neuroscientists. *Neuroscientist* 7:123–135
- Hotz MA, Ritz R, Linder L, Scollo-Lavizzari G, Haefeli WE (2000) Auditory and electroencephalographic effects of midazolam and alpha-hydroxy-midazolam in healthy subjects. *Br J Clin Pharmacol* 49:72–79
- Ishizawa Y (2007) Mechanisms of anesthetic actions and the brain. *J Anesth* 21(2):187–199
- Jelezacov CH, Schwilden H (2003) Bispectral analysis does not differentiate between anaesthesia EEG and a linear random process. *Biomed Tech (Berl)* 48:269–274
- Jevtovic-Todorovic V, Todorovic SM, Mennerick S, Powell S, Dikranian K, Benshoff N, Zorumski CF, Olney JW (1998) Nitrous oxide (laughing gas) is an NMDA antagonist, neuroprotectant and neurotoxin. *Nat Med* 4:460–463
- Jirsa VK, Haken H (1996) Field theory of electromagnetic brain activity. *Phys Rev Lett* 77:960–963
- John ER, Prichep LS, Kox W, Valdes-Sosa P, Bosch-Bayard J, Aubert E, Tom M, diMichele F, Gugino LD (2001) Invariant reversible qEEG effects of anesthetics. *Conscious Cogn* 10:165–183
- Koblin D, Chortkoff B, Laster M, Eger E, Halsey M, Ionescu P (1994) Polyhalogenated and perfluorinated compounds that disobey the Meyer-Overton hypothesis. *Anesth Analg* 79:1043–1048
- Kohn LT, Corrigan JM, Donaldson MS (eds) (2000) Building a safer health system. National Academy Press, Washington
- Koskinen M, Mustola S, Seppanen T (2005) Relation of EEG spectrum progression to loss of responsiveness during induction of anesthesia with propofol. *Clin Neurophysiol* 116:2069–2076
- Kuizenga K, Kalkman C, Hennis P (1998) Quantitative electroencephalographic analysis of the biphasic concentration-effect relationship of propofol in surgical patients during extradural analgesia. *Br J Anaesth* 80:725–732
- Kuizenga K, Wierda J, Kalkman C (2001) Biphasic EEG changes in relation to loss of consciousness during induction with thiopental, propofol, etomidate, midazolam or sevoflurane. *Br J Anaesth* 86:354–360
- Liley DTJ, Cadusch P, Wright J (1999) A continuum theory of electro-cortical activity. *Neurocomputing* 26–27:795–800
- Liley DTJ, Cadusch P, Dafilis M (2002) A spatially continuous mean field theory of electrocortical activity. *Net Comput Neural Syst* 13:67–113
- Liley DTJ, Cadusch P, Gray M, Nathan P (2003) Drug-induced modification of the system properties associated with spontaneous human electroencephalographic activity. *Phys Rev E* 68:051,906
- Liley DTJ, Sinclair N, Lipping T, Heyse B, Vereecke E, Struys M (2010) Propofol and remifentanyl differentially modulate frontal electroencephalographic activity. *Anesthesiology* 113:1–13
- Liley DTJ, Leslie K, Sinclair NC, Feckie M (2008) Dissociating the effects of nitrous oxide on brain electrical activity using fixed order time series modeling. *Comput Biol Med* 38:1121–1130
- Macdonald RL (1994) GABA-A receptor channels. *Annu Rev Neurosci* 17:569–602
- Mihic SJ, Ye Q, Wick MJ, Koltchine VV, Krasowski MD, Finn SE, Mascia MP, Valenzuela CF, Hanson KK, Greenblatt EP, Harris RA, Harrison NL (1997) Sites of alcohol and volatile anaesthetic action on GABA(A) and glycine receptors. *Nature* 389:385–389
- Mohler H, Frittschly JM, Lüscher B, Rudolph U, Benson J (1996) The GABA_A receptors: from subunits to diverse functions. In: Narahashi T (ed) Ion channels, vol 4. Plenum, New York, pp 89–113
- Nunez PL (1974) The brain wave equation: a model for the EEG. *Math Biosci* 21:279–297
- Nunez PL (1981) Electric fields of the brain: The neurophysics of EEG, 1st edn. Oxford University Press, New York

- Pawelzik H, Bannister AP, Deuchars J, Illia M, Thomson AM (1999) Modulation of bistratified cell IPSPs and basket cell IPSPs by pentobarbitine sodium, diazepam and Zn^{2+} : dual recordings in slices of adult rat hippocampus. *Eur J Neurosci* 11:3552–3564
- Rampil IJ (1998) A primer for EEG signal processing in anesthesia. *Anesthesiology* 89(4):980–1002
- Robinson PA, Rennie CJ, Wright JJ (1997) Propagation and stability of waves of electrical activity in the cerebral cortex. *Phys Rev E* 56:826–840
- Robinson PA, Rennie CJ, Wright JJ, Bahramali H, Gordon E, Rowe DL (2001) Prediction of electroencephalographic spectra from neurophysiology. *Phys Rev E* 63:021903
- Rudolph U, Antkowiak B (2004) Molecular and neuronal substrates for general anaesthetics. *Nat Rev Neurosci* 5:709–720
- Schwilden H, Jeleazcov C (2002) Does the EEG during isoflurane/alfentanil anesthesia differ from linear random data? *J Clin Monit Comput* 17:449–457
- Solt K, Eger EI, Raines DE (2006) Differential modulation of human N-methyl-D-aspartate receptors by structurally diverse general anesthetics. *Anesth Analg* 102:1407–1411
- Sonner JM (2008) A hypothesis on the origin and evolution of the response to inhaled anesthetics. *Anesth Analg* 107:849–854
- Stam CJ, Pijn JP, Suffczynski P, Lopes da Silva FH (1999) Dynamics of the human alpha rhythm: evidence for non-linearity? *Clin Neurophysiol* 110:1801–1813
- Swindale NV (2003) Neural synchrony, axonal path lengths and general anesthesia: a hypothesis. *Neuroscientist* 9:440–445
- Tuckwell HC (1988) Introduction to theoretical neurobiology. Linear cable theory and dendritic structure, vol 1. Cambridge University Press, Cambridge
- van Rotterdam A, Lopes da Silva FH, van den Ende J, Viergever MA, Hermans AJ (1982) A model of the spatial-temporal characteristics of the alpha rhythm. *Bull Math Biol* 44:283–305
- Violet JM, Downie DL, Nakisa RC, Lieb WR, Franks NP (1997) Differential sensitivities of mammalian neuronal and muscle nicotinic acetylcholine receptors to general anesthetics. *Anesthesiology* 86:866–874
- Wilson H, Cowan J (1972) Excitatory and inhibitory interactions in localized populations of model neuron. *Biophys J* 12:1–24
- Wilson H, Cowan J (1973) A mathematical theory of the functional dynamics of cortical and thalamic nervous tissue. *Kybernetik* 13:55–80

Chapter 8

Progress in Modeling EEG Effects of General Anesthesia: Biphasic Response and Hysteresis

D.A. Steyn-Ross, M.L. Steyn-Ross, J.W. Sleigh, and M.T. Wilson

8.1 Introduction

The goal of the clinical anesthetist is to deliver to the surgeon a patient whose state of consciousness has been sufficiently suppressed that the person is unaware of surroundings, is unable to form memories, and is unresponsive to painful stimulus. Exactly *how* anesthetic drugs act to induce this altered state of consciousness remains poorly understood. There is clear evidence that general anesthetic agents, such as propofol, have measurable effects at the individual neuron level, but, since “consciousness” is not a property of individual neurons, its reversible suppression must arise from cooperative inhibition of large populations of neurons. The presumption of an anesthetic-induced cooperative change in the level of brain activity leads naturally to the idea that induction of general anesthesia is an enforced global phase transition from an activated, awake brain state to a fully inhibited, quiescent sleep-like state; however, as described in Chap. 2 anesthetic “sleep” differs from natural sleep in that, during anaesthesia, normal arousal mechanisms have been abolished.

We argue that loss of consciousness (LOC) is a global, whole-of-cortex phenomenon. This claim is supported by the fact electroencephalogram- (EEG-) based monitors are able to quantify depth of anesthesia using only a pair of scalp electrodes: a high-density multiple-electrode montage is not required, and the precise on-scalp location of the electrode pair is not critical. This suggests that a useful approach to the problem of modeling anesthesia is to develop a population-based description of cortical function that applies at the centimetric spatial scales sampled by EEG electrodes, rather than attempting to scale up from micron-scale descriptions

D.A. Steyn-Ross (✉)

Department of Engineering, University of Waikato, P.B. 3105, Hamilton 3240, New Zealand

e-mail: asr@waikato.ac.nz

url: <http://phys.waikato.ac.nz/cortex>

of neurons, dendrites, and glia; which in turn depend on nano-scale descriptions of synapses, receptors, and ion channels.

8.1.1 Biphasic Effect and Hysteresis

One of the paradoxical features of general anesthesia is the so-called *biphasic effect*. This refers to the observation that, at low concentrations, anesthetic drugs can produce an excited brain state—described by Guedel (1937) as “delirium”—showing a rise above normal baseline levels in EEG power (Kuizenga et al. 1998, 2001b), and an exaggerated sensitivity to benign environmental stimuli; this surge in brain activity subsides as drug concentration is increased. Further increases in anesthetic concentration suppress brain response to the extent that the patient is rendered safe for surgery. At the end of surgery, anesthetic administration ceases, and the patient moves toward recovery of normal consciousness as her body eliminates the anesthetic agent. During this return phase, a second surge in brain activity is observed around the time of recovery of consciousness (ROC). This unexpected brain response showing *two* biphasic surges per induction–recovery cycle is robust, and is not abolished by multiple inductions of anesthesia. Kuizenga et al. (2001a) investigated EEG responses for patients undergoing three sequential inductions of anesthesia during a single surgical procedure. When the patient awoke after surgery, s/he was put to sleep with a second drug infusion, allowed to recover, then put back to sleep for a third time, followed by eventual recovery. For each of these multiple-induction patients, a total of six EEG-activity surges (three at LOC, three at ROC) were recorded.

The presence of the biphasic response contradicts our naive expectation that brain activity should decline as anesthetic concentration increases. The biphasic effect not only makes extraction of a reliable depth-of-anesthesia index a nontrivial task, but, more fundamentally, it tells us that global brain response to enforced change can be surprising, unpredictable, and highly nonlinear.

The transit from normal consciousness into anesthetic-induced unconsciousness is typically rapid (occurring over a timescale of a few seconds), and binary (the patient is either responding normally or not at all), such that persistent “half-awake” states are rare. This suggests that the descent into—and recovery from—anesthesia might reasonably be modeled as a bistable switching between distinct conscious and unconscious brain states (Steyn-Ross et al. 1999, 2004), and that it should be possible to observe a hysteresis separation between the drug concentrations measured at the LOC and ROC transition points, i.e., the patient is expected to awaken at a *lower* concentration of anesthetic drug than that required to put him or her to sleep.

8.1.2 Progress in Anesthesia Modeling

Our original anesthesia model, as described in Steyn-Ross et al. (1999), and in follow-up papers (Steyn-Ross et al. 2001a, 2001b, 2003, 2004), was formulated as a

stochastic generalization of the mean-field cortical equations of Liley et al. (1999). The phenomenological addition of low-intensity white-noise stimulation entering from subcortical sources allows the cortical system to explore its state space, and recognizes the fact that the cortex, like all biological systems, is buffeted by a continuous flux of random perturbations generated by a variety of external and internal sources. The effect of a GABAergic anesthetic drug (such as propofol) was modeled as a temporal prolongation of the decay phase of the inhibitory postsynaptic potential (IPSP); the degree of prolongation was presumed to be a monotonic function of anesthetic concentration in the brain. In order to simplify analysis of the cortical equations, we imposed a separation of time-scales such that, relative to soma voltages, the dendritic flux inputs were taken to be fast, rapidly equilibrating variables, so could be set equal to their steady-state values; in addition, we neglected spatial variations, taking the cortical sheet to be spatially homogeneous. These simplifications (the “slow-soma spatio-adiabatic limit”) reduced the system complexity to a pair of coupled stochastic differential equations (for excitatory and inhibitory soma voltages V_e and V_i). We located numerically the homogeneous equilibrium states, and established that, for some plausible values of cortical parameters, there could be multiple steady states for a given value of anesthetic effect, leading to the possibility that loss of consciousness (LOC) might correspond to a first-order switching transition from an activated “up” state to a low-firing “down” state.

We computed the theoretical fluctuation variance and fluctuation spectrum of the excitatory soma voltage (taken as a proxy for EEG) as a function of anesthetic effect. The surprising and unanticipated finding was the prediction of a *surge* in low-frequency cortical activity on close approach to the “up”-to-“down” jump point (LOC), and a second, more pronounced surge for the return trajectory as the anesthetic concentration diminished toward the critical value for the “down”-to-“up” ROC (recovery of consciousness) transition. It was subsequent to this discovery that we learned that general anesthetic drugs are known to evoke *biphasic* EEG activity peaks during both induction and recovery (Kuizenga et al. 1998, 2001a, 2001b). Mathematically, the power surge in the cortical equations arises from the divergent critically slowed fluctuations generated in close proximity to a saddle-node annihilation point (Steyn-Ross et al. 2006).

Bojak and Liley (2005) investigated isoflurane anesthesia using the Liley et al. (1999) equations, and showed that, for suitable choices of cortical parameters (obtained after running very extensive swarm searches), biphasic activity surges in EEG activity can be generated *without* requiring a phase transition between distinct neural states. Instead, they argue that the path from wakefulness to anesthesia is a smoothly continuous transition, implying that the recovery trajectory *out* of anesthesia will be a symmetric retracing of that for entry *into* anesthesia. This suggests that, aside from pharmacokinetic delays, there should be no hysteresis effects in the EEG power surges during the induction and recovery phases, i.e., the biphasic peaks for entry and exit should occur at the *same* level of anesthetic concentration.

Liley and Bojak (2005) applied their mean-field model to the paradoxical clinical finding that some anesthetic agents (such as enflurane) can act as pro-convulsants, causing epileptiform activity in patients with no history of epilepsy. By comparing the subtle differences in IPSP responses for isoflurane (a non-seizurogenic

anesthetic) versus enflurane, Liley and Bojak were able to demonstrate that the enflurane-induced reduction in IPSP amplitude could lead to a low-frequency (~ 3 Hz) Hopf instability of seizure-like character. Similar theoretical findings were reported by Wilson et al. (2006), building on a continuum model developed to model sleep dynamics (Wilson et al. 2005) and sleep cycling (Steyn-Ross et al. 2005).

Molae-Ardekani et al. (2007) enhanced the earlier anesthesia models of Steyn-Ross et al. (1999, 2004) and Bojak and Liley (2005) by incorporating a slow ionic modulation of the sigmoidal voltage-to-firing-rate mapping for pyramidal (excitatory) neurons. This change introduces a gating variable that activates a slow *inward* (depolarizing) current when the excitatory population is the “down” (low-firing) state, and a slow *outward* (hyperpolarizing) current when the population is in the “up” (high-firing) state, and allows the mean-field model to exhibit three distinct modes of activity: continuous firing in the up-state (awake); phasic firing (bursts followed by periods of silence) as the neurons cycle between up- and down-states (anesthetized); and continuous silence in the down-state (deep coma). Although the authors do not discuss hysteresis effects, their model traces a single equilibrium branch into unconsciousness (see Fig. 11 of Molae-Ardekani et al. 2007), so a separation between LOC and ROC biphasic events is not predicted for steady-state conditions, but might arise as a transient artifact when the rate of change of anesthetic concentration is rapid.

Foster et al. (2008) provides a comprehensive overview of mean-field anesthesia modeling for the period up until 2007.

In two recent papers (Hutt and Schimansky-Geier 2008; Hutt and Longtin 2010), Hutt and colleagues have developed a neural model to investigate anesthetic-induced biphasic changes in EEG power. They derive the power spectrum for fluctuations in the *effective* potential $V_e - V_i$, the difference between average soma potentials at the excitatory and inhibitory neural populations, arguing that the dendritic current that generates the scalp EEG is proportional to this voltage difference. They establish analytical expressions for the EEG power spectrum, and demonstrate that biphasic power surges can occur in both single- and multiple-steady-state cases. Thus their new model can exhibit a first-order anesthetic phase transition similar to that of Steyn-Ross et al. (2004), and also a smoothly continuous transition like that of Bojak and Liley (2005) and Liley and Bojak (2005). This commonality in anesthetic behaviors between the reduced Hutt model and variations of the Liley model is attributed to fact that they share several major elements: interactions between excitatory and inhibitory neural populations; a nonlinear (sigmoidal) mapping between soma voltage and firing rate; distinct response functions at excitatory and inhibitory synapses.

8.2 Mean-Field Model for Anesthesia

We now present a summary of our cortical model for anesthesia that is based on the Liley et al. (1999) equations, but since modified to incorporate ideas and parameter values drawn from Wright et al. (2001), Rennie et al. (2000), and Robinson et al.

(1998). A full derivation of the present form of the cortical equations is given in Steyn-Ross et al. (2007).

We represent the cortex as interacting populations of excitatory (e) and inhibitory (i) neurons whose average soma voltages V_e and V_i determine the local firing rates Q_e and Q_i . The mapping from membrane voltage to firing rate follows a standard sigmoidal form given in (8.7) and plotted in Fig. 8.1. The firing rates $Q_{e,i}$ act as local and long-range source terms for the pulse fluxes $\Phi_{e,i}$ entering the neural populations via chemical synapses at the dendrites. These incoming dendritic fluxes, moderated by ionic reversal potentials, induce excitatory or inhibitory postsynaptic potentials (PSPs) that are integrated at the soma to determine the soma potential. [In addition to flux input via chemical synapses, the model can be generalized to include diffusive input via gap junctions—electrical synapses—that form direct resistive links between inhibitory neurons (Steyn-Ross et al. 2007, 2009, 2010b), but we do not consider gap-junction effects in this chapter.]

8.2.1 Model Equations

The excitatory and inhibitory soma voltages are given by partial differential equations,

$$\tau_e \frac{dV_e}{dt} = V_e^{\text{rest}} + \delta V_e^{\text{rest}} - V_e + \rho_e \Phi_e \psi_{ee} + \rho_i \Phi_i \psi_{ie}, \quad (8.1)$$

$$\tau_i \frac{dV_i}{dt} = V_i^{\text{rest}} - V_i + \rho_e \Phi_e \psi_{ei} + \rho_i \Phi_i \psi_{ii}. \quad (8.2)$$

Here, $\tau_{e,i}$ are average neuron time-constants (see Table 8.1 for parameter values); $V_{e,i}^{\text{rest}}$ are neuron resting voltages, and δV_e^{rest} is a fixed offset in resting voltage representing an overall level of neural excitation ($\delta V_e^{\text{rest}} > 0$) or suppression ($\delta V_e^{\text{rest}} < 0$); $\rho_{e,i}$ are signed synaptic strengths with $\rho_e > 0$ (excitation) and $\rho_i < 0$ (inhibition). Following Liley et al. (1999) and Rennie et al. (2000), the ψ_{ab} (where a and b are labels with $a = e$ or i , and $b = e$ or i) are reversal-potential functions that are normalized to unity when the membrane voltage is at resting value, and zero when the membrane voltage reaches the relevant reversal potential, taken to be $V_e^{\text{rev}} = 0$ mV for excitatory (AMPA) receptors, and $V_i^{\text{rev}} = -70$ mV for inhibitory (GABA) receptors,

$$\psi_{ab} = \frac{V_a^{\text{rev}} - V_b}{V_a^{\text{rev}} - V_b^{\text{rest}}}, \quad a, b \in \{e, i\}. \quad (8.3)$$

The $\Phi_{e,i}$ functions in (8.1)–(8.2) are postsynaptic input fluxes obeying second-order differential equations,

$$\left(\frac{d}{dt} + \gamma_e \right)^2 \Phi_e = \gamma_e^2 [N_e^\alpha \phi_e^\alpha + N_e^\beta Q_e + \phi_e^{\text{sc}}], \quad (8.4)$$

$$\left(\frac{d}{dt} + \gamma_i \right)^2 \Phi_i = \gamma_i^2 N_i^\beta Q_i. \quad (8.5)$$

Table 8.1 Standard values for the cortical model

Symbol	Description	Value	Unit
$\tau_{e,i}$	neuron time-constant	0.040, 0.040	s
$V_{e,i}^{\text{rev}}$	reversal potential at dendrite	0, -70	mV
$V_{e,i}^{\text{rest}}$	neuron resting potential	-64, -64	mV
ρ_e	excitatory synaptic gain	1.35×10^{-3}	mV·s
ρ_i^0	inhibitory synaptic gain at zero anesthetic	-1.00×10^{-3}	mV·s
γ_e	excitatory rate-constant	100	s^{-1}
γ_i^0	inhibitory rate-constant at zero anesthetic	85	s^{-1}
N_e^α	number of long-range connections from excitatory neurons	1550	–
N_e^β	number of local connections from excitatory neurons	1000	–
N_i^β	number of local connections from inhibitory neurons	450	–
$\langle \phi_e^{\text{sc}} \rangle$	subcortical tonic activity	600	s^{-1}
v	axonal conduction speed	140	cm s^{-1}
Λ_e	inverse-length scale for long-range axonal connections	4	cm^{-1}
$Q_{e,i}^{\text{max}}$	maximum firing rate	30, 60	s^{-1}
$\theta_{e,i}$	sigmoid threshold voltage	-58, -58	mV
$\sigma_{e,i}$	standard deviation for threshold	3, 5	mV
α	noise amplitude scale-factor	0.2	–

The $\gamma_{e,i}$ are rate-constants for the postsynaptic response. For anesthetic modeling, we reduce the inhibitory rate-constant γ_i (i.e., we lengthen the duration of the inhibitory postsynaptic potential) while maintaining the IPSP amplitude—this is discussed further in Sect. 8.2.2. The three excitatory source fluxes appearing on the right of (8.4) arise from delayed activity at *nonlocal* populations via myelinated cortico-cortical connections (ϕ_e^α), from immediate *local* activity (Q_e), and from a continuous background of nonspecific *subcortical* tone (ϕ_e^{sc}). The N_e^α, N_e^β are, respectively, the number of long-range and local incoming excitatory synaptic connections. The simpler form of (8.5) reflects the fact that inhibitory flux arrives exclusively from local sources: there is no long-range inhibition in our cortical model.

For the long-range cortico-cortical flux ϕ_e^α , we follow Robinson et al. (1997) by adopting a two-dimensional damped wave equation driven by excitatory sources Q_e ,

$$\left[\left(\frac{\partial}{\partial t} + v\Lambda_e \right)^2 - v^2 \nabla^2 \right] \phi_e^\alpha = v^2 \Lambda_e^2 Q_e, \quad (8.6)$$

where v is the average axonal conduction speed, and Λ_e is an inverse-length scale for the long-range axonal connections.

The $Q_{e,i}$ sigmoidal functions plotted in Fig. 8.1 describe the population-averaged mapping from soma voltage to firing rate,

$$Q_a = \frac{Q_a^{\text{max}}}{1 + \exp[-C(V_a - \theta_a)/\sigma_a]}, \quad a = e, i, \quad (8.7)$$

Fig. 8.1 Sigmoidal mapping (8.7) from membrane voltage $V_{e,i}$ to firing rate $Q_{e,i}$. Vertical dashed line marks the threshold voltage which is set at $\theta_{e,i} = -58$ mV for both excitatory (e) and inhibitory (i) populations. (See Table 8.1 for list of parameter values)

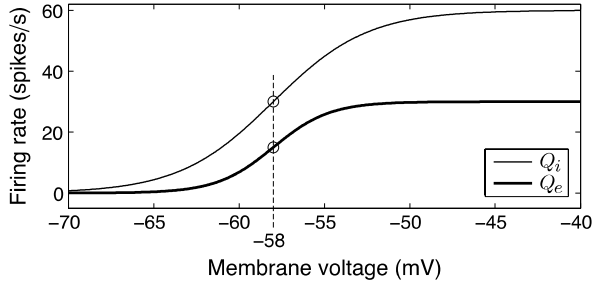

with $C = \pi/\sqrt{3}$. Here, θ_a is the population-average threshold for firing, σ_a is its standard deviation, and Q_a^{\max} is the maximum firing rate.

We write the subcortical activation ϕ_e^{sc} in (8.4) as a noisy fluctuation about a constant tonic background $\langle \phi_e^{\text{sc}} \rangle$,

$$\phi_e^{\text{sc}}(\mathbf{r}, t) = \langle \phi_e^{\text{sc}} \rangle + \alpha \sqrt{\langle \phi_e^{\text{sc}} \rangle} \xi(\mathbf{r}, t) \quad (8.8)$$

where ξ is a Gaussian-distributed, zero-mean, delta-correlated spatiotemporal white noise,

$$\langle \xi(\mathbf{r}, t) \rangle = 0, \quad (8.9)$$

$$\langle \xi(\mathbf{r}, t) \xi(\mathbf{r}', t') \rangle = \delta(\mathbf{r} - \mathbf{r}') \delta(t - t'), \quad (8.10)$$

and α is a dimensionless factor for convenient scaling of the noise intensity. In a real brain, it is known that silencing of the continuous wash of nonspecific background activity entering from the brainstem (e.g., following lesion or traumatic accident) causes the cortex to immediately lapse into a comatose state (Kelly 1991), therefore a noisy subcortical stimulus seems to be an essential prerequisite for normal cortical function. The inclusion of additive white noise in the model is our heuristic attempt to capture this element of neurophysiology. We use “white” (i.e., spectrally flat) noise as a mathematical idealization that enables us to compute the theoretical equilibrium spectrum of the electrocorticogram (ECoG), and to track its spectral variations during induction of anesthesia. It turns out that our cortical model acts as a lowpass filter that strongly attenuates higher frequencies, so the presence of unphysiologically high frequencies in our stimulus noise is probably of little consequence.

8.2.2 Modeling Effect of Propofol Anesthetic

There is accumulating evidence that, at the molecular level, general anesthetic agents act directly on neurotransmitter-gated ion channels to suppress neural activity by either decreasing excitation, or increasing inhibition, or both. Dissociative anesthetics (such as ketamine, nitrous oxide, xenon) reduce excitatory currents by blocking NMDA receptors (Franks et al. 1998), while inductive anesthetics (e.g.,

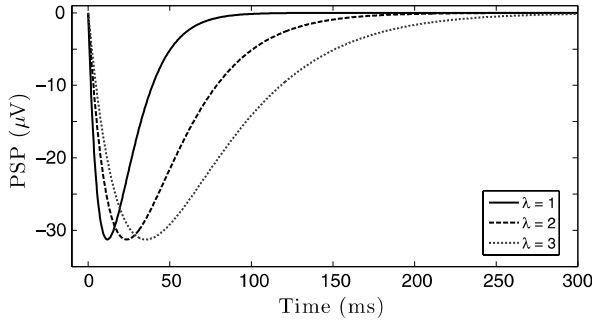

Fig. 8.2 Time course of the inhibitory postsynaptic potential (IPSP) for three settings of anesthetic effect λ . The curves are scaled alpha-functions of the form $\text{PSP}(t) = \rho\gamma^2 t \exp(-\gamma t)$ with synaptic strength $\rho = \lambda\rho_i$ and rate-constant $\gamma = \gamma_i/\lambda$. With increasing anesthetic concentration, the area and time-to-peak ($1/\gamma$) both scale linearly with λ , while the peak height remains unchanged

halothane, isoflurane, propofol) strongly potentiate inhibitory currents by opening GABA receptors (Franks and Lieb 1994), allowing more chloride (Cl^-) ions to enter the postsynaptic neuron. Unlike some inductive agents at clinically relevant concentrations, propofol has little effect on excitatory synapses; its primary effect is to prolong the duration of the decay phase of inhibitory response without altering its peak amplitude (Kitamura et al. 2002).

The unitary impulse response (i.e., response per individual synaptic spike) for our model inhibitory synapse is obtained by replacing the $\gamma_i^2 N_i^\beta Q_i$ source term on the right-hand side of (8.5) with the scaled delta-function $\gamma_i^2 \delta(t)$,

$$\left(\frac{d}{dt} + \gamma_i\right)^2 \Phi_i = \gamma_i^2 \delta(t), \quad (8.11)$$

whose solution has an alpha-function form,

$$\Phi_i(t) = \gamma_i^2 t e^{-\gamma_i t} \Theta(t), \quad (8.12)$$

where $\Theta(t)$ is the Heaviside (unit-step) function. Multiplying by synaptic strength ρ_i gives the unitary inhibitory postsynaptic potential (IPSP) graphed with a solid-black line in Fig. 8.2. To follow the IPSP effect of propofol, we introduce a dimensionless scale-factor λ that is set to unity in the absence of propofol, and which grows proportionately to propofol concentration. We then scale both the inhibitory rate-constant γ_i and synaptic strength ρ_i ,

$$\gamma_i = \gamma_i^0 / \lambda, \quad \rho_i = \lambda \rho_i^0$$

where γ_i^0 and ρ_i^0 are the default values for rate-constant and synaptic strength (see Table 8.1 for values) that apply when the concentration of propofol anesthetic is zero (i.e., when $\lambda = 1$). These rescalings ensure that the area of the IPSP response function (representing the total charge transfer) increases linearly with drug concentration while retaining constant peak height. Figure 8.2 shows the result of setting $\lambda = 1, 2, 3$. We note that this area-scaling of the alpha-function PSP is the same as that used in our original anesthesia modeling paper (Steyn-Ross et al. 1999).

One non-ideal aspect of using a constant-height alpha-function to model IPSP is that the time-to-peak increases linearly with drug concentration, whereas experimental measurements show that anesthetics prolong inhibitory rise-time much less than decay-time. Bojak and Liley (2005) and Hutt and Longtin (2010) both address this problem by replacing the alpha-function with a biexponential form of constant height. Bojak and Liley constrain the rise-time to be constant, while Hutt and Longtin adopt a slightly simpler algebraic form in which the time-to-peak increases slightly with anesthetic concentration. In future work it would be interesting to assess the dynamical consequences of these three different choices for IPSP response.

8.2.3 *Equilibrium States of the Cortex*

In order to explore the effect of altering anesthetic concentration on the cortical model, we identify the spatially uniform equilibrium states corresponding to a given level of anesthetic effect λ and cortical activation δV_e^{rest} , then investigate their stability with respect to small perturbations. Our working assumption is that noise-induced voltage fluctuations about such steady states are the source of the ECoG signal (detected via cortical electrodes) and of the EEG signal (via scalp electrodes).

To locate the homogeneous steady states, we remove the subcortical noise (i.e., set noise scale-factor $\alpha = 0$ in (8.8)), set to zero all time- and space-derivatives in (8.1)–(8.2), (8.4)–(8.6), then solve numerically the resulting nonlinear algebraic equations for the steady-state excitatory and inhibitory soma voltages ($V_e^{(0)}$, $V_i^{(0)}$) and firing rates ($Q_e^{(0)}$, $Q_i^{(0)}$) across the anesthesia domain. By sampling the domain coordinates sufficiently finely, we are able to map out the smooth distribution of equilibrium states shown in Fig. 8.3. Of particular interest is the observation that, for a certain subspace of the domain, the steady-states manifold folds back on itself to form an S-shaped reentrancy. This means that all $(\lambda, \delta V_e^{\text{rest}})$ coordinates within the fold boundaries—marked with a dashed-white line in Fig. 8.3—are associated with *two or three* steady states, while all domain coordinates outside the extent of the fold are associated with *single* steady states.

We have traced four putative induction–emergence anesthesia trajectories (labeled i, ii, iii, iv) on the Fig. 8.3 manifold. Respectively, each trajectory corresponds to increasing, then decreasing, levels of propofol at one of four fixed levels for cortical excitability, represented as fixed offsets $\delta V_e^{\text{rest}} = \{0, 1.5, 2.9474, \text{ or } 4.5\}$ mV from the default excitatory resting voltage $V_e^{\text{rest}} = -64$ mV (see Table 8.1). Tours-i ($\delta V_e^{\text{rest}} = 0$ mV) and -ii (1.5 mV) traverse both the multi-state and single-state regions, while tour iii (2.9474 mV) just *grazes* the cusp point separating the two, and tour iv (4.5 mV) is entirely within the domain of single states.

We identify the conscious “awake” state (labeled *A* on path i) with the elevated firing rates of the top branch, and the fully anesthetized or “comatose” state (labeled *C*) with the depressed firing rates of the bottom branch. The point labeled *I* (“induction”) marks the saddle–node annihilation point beyond which the steady

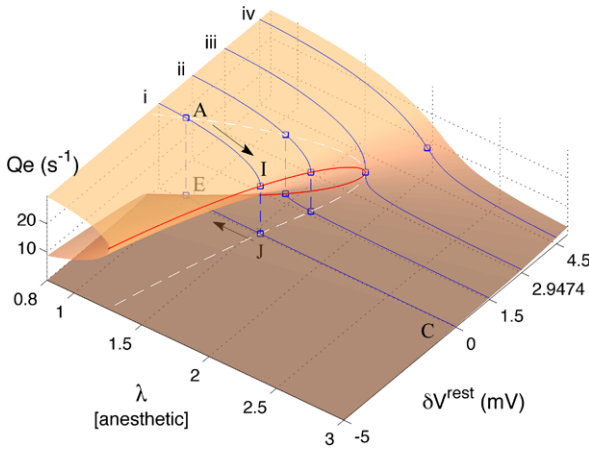

Fig. 8.3 Manifold of steady-state firing rates $Q_e^{(0)}$ across the $(\lambda, \delta V^{\text{rest}})$ anesthesia domain. Multiplicative control parameter λ sets the anesthetic effect; δV^{rest} is an additive offset representing the overall level of cortical excitation ($\delta V^{\text{rest}} > 0$) or suppression ($\delta V^{\text{rest}} < 0$) of the excitatory neural population. *Red curve* marks the edge of the reentrant “fold” in the manifold; *dashed-white curve* shows the projection of this edge onto the lower and upper surfaces, demarcating the region containing multiple (two or three) steady states. Labels *i* to *iv* indicate four candidate induction–recovery tours (*blue lines*) across the domain; *dashed-blue lines* show jump discontinuities from a saddle–node annihilation point to the other branch. For example, tour *i* runs from *A* (awake) to *I* (induction) to *J* to *C* (coma), then recovers via *C* to *E* (emergence) back to awake at *A*. Tour-*iii* passes through the double saddle–node (“opalescent”) critical point, while tour *iv* is entirely within the single-root regime. The distance between the *dashed-blue verticals* on tour *i* (or *-ii*) shows the maximum extent of the predicted hysteresis separation between induction and emergence transition points. (See Figs. 8.4, 8.5 for stability characteristics of the manifold)

states belonging to the top and middle (i.e., the reentrant underhang) branches have merged and disappeared. This is the last point at which induction of anesthesia can occur since, being continuously buffeted by noise, a stochastically driven cortex is likely to jump *prior* to the turning point, with the probability of an early jump increasing with noise intensity.

For our idealized noise-free trajectory along tour *i*, increasing drug concentration leads to an induction of anesthesia that proceeds from *A* to *C* via a downwards jump transition $I \downarrow J$. Later, as the drug wears off (via catabolism or elimination), the cortex recovers its awake state via the reverse path from *C* to *A* via an upwards jump $E \uparrow A$ from the lower-branch emergence point *E*. The fact that these two jump transitions occur at different domain coordinates implies that the patient will awaken at a *lower* level of anesthetic concentration than that required to put her to sleep. Thus the model predicts that—for multi-root tours *i* and *ii*—the brain will exhibit *hysteresis*, i.e., the brain response to anesthesia will show history-dependence, and one cannot assume a one-to-one correspondence between brain state and anesthetic level.

Such a hysteresis would provide a measure of “protective inertia” for the incumbent cortical state that would prevent unstable bouncing between wake and sleep at

the critical point of induction.¹ It has been suggested that similar hysteretic mechanisms help stabilize the wake and natural sleep states, and that lack of adequate sleep/wake hysteresis might provide a natural explanation for narcolepsy (Phillips and Robinson 2007; Robinson et al. 2010).

Because tours iii and iv on Fig. 8.3 are *continuous* descents into anesthesia, no static hysteresis effects are expected, although, as we will show in our numerical simulations in Sect. 8.2.6, a form of *dynamic* hysteresis can appear if the trajectory traverses a region of temporal instability.

We acknowledge that increases in anesthetic concentration are likely to reduce cortical excitability (e.g., via drug-induced reductions in subcortical tone) as induction of anesthesia proceeds. However, we have chosen to investigate the “pure- λ ” paths as a simple way of exploring the anesthetic domain. More realistic “slant-path” tours in which λ and δV_e^{rest} co-vary simultaneously could readily be investigated in future work.

We now examine the stability characteristics of the model cortex during wake and under anesthesia.

8.2.4 Cortical Stability Under Anesthesia

Our cortical system comprises two first-order (8.1)–(8.2) and three second-order differential equations (8.4)–(8.6). We decompose the latter into pairs of first-order equations, giving a total of eight first-order differential equations in time; the state of the cortex is then defined by its eight-dimensional state vector $\mathbf{X}(\mathbf{r}, t) = [V_e, V_i, \Phi_e, \dot{\Phi}_e, \Phi_i, \dot{\Phi}_i, \phi_e^\alpha, \phi_e^{\alpha}]^T$.

To determine the linear stability of the deterministic system, we set the noise to zero, then express each element of the state vector as the sum of its equilibrium value $X^{(0)}$ plus a small plane-wave perturbation of magnitude $\tilde{X}(t)$ in two-dimensional space,

$$\mathbf{X}(\mathbf{r}, t) = \mathbf{X}^{(0)} + \tilde{\mathbf{X}}(t)e^{i\mathbf{q}\cdot\mathbf{r}} \quad (8.13)$$

where \mathbf{q} is the wave-vector with magnitude $q = |\mathbf{q}|$ and wavelength $2\pi/q$. After substituting (8.13) into the differential equations (8.1)–(8.2), (8.4)–(8.6) and retaining only first-order perturbations, the equations of motion for the cortex reduce to the constant-matrix form,

$$\frac{d}{dt}\tilde{\mathbf{X}}(t) = M(q)\tilde{\mathbf{X}}(t), \quad (8.14)$$

where M is the 8×8 Jacobian matrix evaluated at equilibrium. This is a sparse matrix containing 19 nonzero terms. Its q -dependence arises from the ∇^2 operator in (8.6), generating a $-q^2$ term.

¹This is analogous to the noise immunity provided by the positive-feedback hysteresis engineered into an electronic Schmitt trigger for clean binary switching in digital circuits.

At each equilibrium point, we compute the eight eigenvalues of M for a closely spaced range of wavenumbers q , retaining only the *dominant* eigenvalue—i.e., that eigenvalue which has the most positive (or least negative) real part—for each q -value. Writing the spectrum of dominant eigenvalues as the sum of real and imaginary parts,

$$\Lambda^{\text{dom}}(q) = \alpha(q) + i\omega(q),$$

we assess linear stability as follows:

- if $\alpha(q) < 0$ for all q -values, then all spatial modes will decay with time, so the uniform (homogeneous) steady state is *stable* with respect to small perturbations;
- if $\alpha(q) > 0$ for any q -value, then the equilibrium state is *unstable*; undamped q -modes will grow monotonically if $\omega(q) = 0$, or, if $\omega(q) \neq 0$, will develop growing oscillations at angular frequency $\omega(q)$;
- for the unstable case, early growth is dominated by the spatial mode with largest α -value;
- for the marginal case $\alpha(q) = 0$, spatial modes will be long-lived (i.e., neither growing nor decaying), leading to *critically slowed fluctuations*.

For all settings of the present anesthesia model, our eigenvalue analysis shows that the $q = 0$ mode is always less damped than all higher-frequency spatial modes, and that if an instability sets in, it is always the $q = 0$ (i.e., infinite wavelength) mode that is most unstable. This means that a cortical instability will tend to manifest as a global, whole-of-cortex oscillation without spatial structure. This is consistent with a stability analysis by Wilson et al. (2005, 2010) when examining a variant of the present model to investigate sleep dynamics, and also with earlier work by Robinson et al. (1997) using a different continuum model. (However, we should point out that the inclusion of inhibitory gap-junction diffusion in a generalized version of the present model predicts a range of spatiotemporal instabilities such as Turing patterns and traveling waves (Steyn-Ross et al. 2007, 2010b).)

Figures 8.4 and 8.5 illustrate two alternative stability maps for the anesthesia equilibrium manifold drawn in Fig. 8.3; respectively, these maps correspond to zero-anesthetic default values for IPSP rate-constant of $\gamma_i^0 = 85$ and 50 s^{-1} . Each map is presented as a bird’s-eye view with “xray” penetration to the top, middle, and bottom branches of the manifold. The multi-states boundary (*red line* in Fig. 8.3) is represented by the outlined triangular wedges opening to the top-left corner of the Figs. 8.4, 8.5 panels.

For both figures, the *left-hand panels* display $\alpha = \text{Re}(\Lambda^{\text{dom}})$, the real part of the dominant eigenvalue for the $q = 0$ spatial mode, while the *right-hand panels* show the expected oscillation frequency (in Hz) $f = \omega/2\pi = \text{Im}(\Lambda^{\text{dom}})/2\pi$ for those regions for which an instability is predicted (i.e., at those $(\lambda, \delta V_e^{\text{rest}}, Q_e^{(0)})$ domain coordinates for which $\alpha > 0$). The relative stability of the equilibrium states can be determined from the colorbar on the left (*blue* = very stable; *green* = stable; *yellow* = marginal; *orange* = unstable; *red* = highly unstable). The unstable equilibria suggest emergence of growing Hopf oscillations (subsequently confirmed in numerical simulations) whose frequencies range from 0 (*blue*) to 4 Hz (*red*)—see frequency colorbar on the right.

Inspection of Fig. 8.4 (middle-left panel) shows that the mid-branch (the reentrant upper surface “inside” the fold) is everywhere unstable, and that, apart from a very narrow strip running along the upper and lower edges of the multi-root region, the top (upper-left panel) and bottom (lower-left panel) branches are stable with respect to small perturbations. These narrow strips of zero-frequency instability arise from the annihilation of node- and saddle-fixed points that occurs along the manifold edge where three distinct equilibria collapse to one.

It is interesting to observe the fanlike aura of low-frequency instability that radiates out from the cusp marking the double saddle–node annihilation event at the extreme limit of the multi-root region. This projection of dynamical effect into the single-root region is similar to the bottleneck slowing for trajectories passing through the shadow zone of a saddle–node “ghost” (Strogatz 2000; Fulcher et al. 2008; Steyn-Ross et al. 2010a), except that here, the zero-frequency saddle–node remnant apparent in Fig. 8.4 (middle-right panel) is bracketed by low-frequency Hopf instabilities.

Reducing the default IPSP rate-constant γ_i^0 from 85 to 50 s⁻¹ (Fig. 8.5) causes the zone of Hopf instability to grow significantly, invading the multi-root region (see top- and bottom-right panels). This invasion means that an anesthesia induction along say, $\delta V_e^{\text{rest}} = 0$ mV, can now destabilize (and jump “early” to the bottom branch) via a ~ 3 -Hz Hopf bifurcation *prior* to the trajectory encountering the saddle–node bifurcation at the manifold edge. (This has been verified in numerical simulations, but not shown here.)

We now compute the small-signal fluctuation spectra for the case of stable equilibria, then test the theoretical predictions against 2-D numerical grid simulations of the full nonlinear system equations for three sample induction–emergence anesthesia trajectories. Finally, we will compare our model results against clinical spectra extracted from ECoG time-series recorded from a sheep undergoing propofol anesthesia.

8.2.5 Theoretical Fluctuation Spectra

In our cortical model, noise enters from the subcortex. This noisy stimulus evokes a fluctuation spectrum which we can compute by linearizing the stochastic differential equations about homogeneous steady state to derive an eight-variable Ornstein–Uhlenbeck (Brownian motion) description for the fluctuations,

$$\frac{d}{dt} \tilde{\mathbf{X}}(\mathbf{r}, t) = \hat{M} \tilde{\mathbf{X}}(\mathbf{r}, t) + \sqrt{D} \mathbf{v}(\mathbf{r}, t), \quad (8.15)$$

where \hat{M} is an 8×8 matrix operator containing the ∇^2 -term, D is a sparse 8×8 diffusion matrix with a single nonzero element that defines noise intensity,

$$\sqrt{D_{44}} = \gamma_e^2 \alpha \sqrt{\langle \phi_e^{\text{sc}} \rangle}, \quad (8.16)$$

and \mathbf{v} is the sparse noise vector containing the white-noise source,

$$\mathbf{v}(\mathbf{r}, t) = [0, 0, 0, \xi(\mathbf{r}, t), 0, 0, 0, 0]^T. \quad (8.17)$$

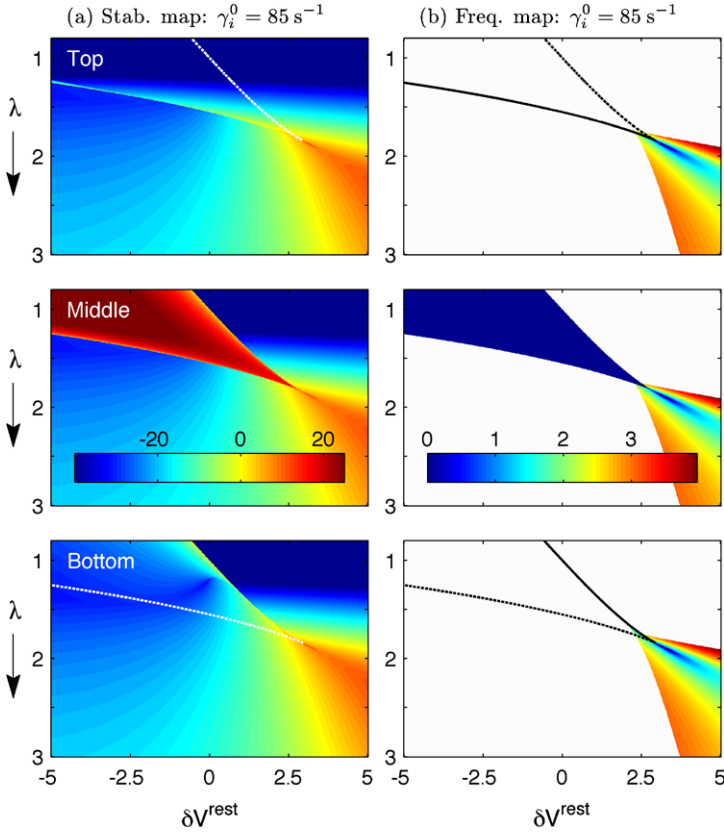

Fig. 8.4 Stability and frequency map across the anesthetic domain for $\gamma_i^0 = 85 \text{ s}^{-1}$. *Left-hand panels* display the real part of the dominant eigenvalue $\alpha = \text{Re}(\Lambda^{\text{dom}})$ (units: s^{-1}) for the $q = 0$ (i.e., whole-of-cortex) spatial mode; *right-hand panels* show the predicted Hopf oscillation frequency $f = \text{Im}(\Lambda^{\text{dom}})/2\pi$ (units: Hz) for the $\alpha > 0$ instability points. Within the multi-root region, the zones of instability on the top and bottom branches are confined to a narrow strip close to the edge; within these zones, the cortex destabilizes via a saddle–node bifurcation

Following Chaturvedi et al. (1977) and Wilson et al. (2005), we can write the power fluctuation for each Fourier component $S(\mathbf{q}, \omega)$ as

$$S(\mathbf{q}, \omega) = \frac{1}{2\pi} (M(\mathbf{q}) + i\omega I)^{-1} D (M^T(\mathbf{q}) - i\omega I)^{-1}. \quad (8.18)$$

We used this equation to track the changes in fluctuation spectra for three of the sample anesthesia trajectories (tours i–iii) drawn on Fig. 8.3. Consistent with the linear stability analysis, we found that the $q = 0$ uniform spatial mode dominates all higher-frequency spatial modes, so the work reported here is confined to the $q = 0$ case. The theoretical band-power results for the induction–emergence trajectories are presented in the next section (see Fig. 8.7) as (dotted) reference curves against which the spectra obtained from numerical simulations could be checked. We em-

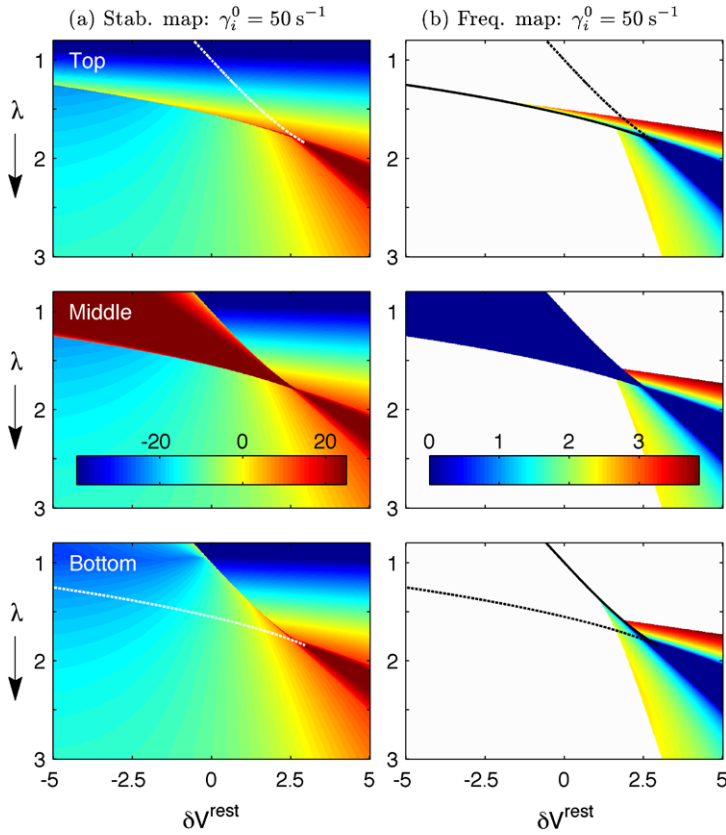

Fig. 8.5 Stability and frequency map across the anesthetic domain for $\gamma_i^0 = 50 \text{ s}^{-1}$. Compared with Fig. 8.4, the lowering of the default value for IPSP rate-constant has reduced the area of the stable region, with tongues of Hopf instability now invading both the top and bottom branches of the multi-root region

phasize that the linear theory is only valid when the equilibrium state is stable; no spectral predictions are possible when the equilibrium state becomes unstable—as happens, for example, during the tour iii crossing of the Hopf “lake of instability” (see panel (iii) of Figs. 8.6 and 8.7).

8.2.6 Numerical Simulations for Anesthesia Induction and Recovery

As a cross-check on the (8.18) spectral predictions, we ran a series of numerical simulations of the full cortical system as defined by differential equations (8.1)–(8.2), (8.4)–(8.6). In these simulations, the cortex is represented as a 6-cm square of tissue whose opposite edges are joined to give toroidal boundary conditions. The cortical

sheet is mapped to a 60×60 grid, giving a spatial resolution of $\Delta x = \Delta y = 1$ mm; the time-step is set at $\Delta t = 0.4$ ms. We use a first-order Euler updating algorithm in time; the wave equation ∇^2 -operator is implemented using the MATLAB `convolve2` function² in `wrap` (toroidal) mode. The subcortical stimulation of (8.8) contains deterministic and stochastic parts, and is discretized as

$$(\phi_e^{\text{sc}})_{i,j}^n = \langle \phi_e^{\text{sc}} \rangle + \alpha \sqrt{\langle \phi_e^{\text{sc}} \rangle} \frac{\mathcal{R}_{i,j}^n}{\sqrt{\Delta t}}, \quad i, j = 1, \dots, 60, \quad (8.19)$$

where n is the time-index (i.e., $t = n\Delta t$), and (i, j) is the grid coordinate. Here, $\mathcal{R}_{i,j}$ is a zero-mean, unit-variance Gaussian-distributed spatiotemporal white noise that is uncorrelated in space and time. It delivers continuous noisy stimulation to the entire cortical grid.

For a given fixed value of δV_e^{rest} , we ran two lengthy numerical experiments: first, anesthetic scale-factor λ was gradually increased over 10 mins from 0.8 to 3.0 to simulate *induction* of anesthesia, then, for the *recovery* phase, λ was decreased from 3.0 to 0.8 over a further 10-min interval.

Figure 8.6 shows representative time-series for a selected point on the cortical grid for three settings of δV_e^{rest} : (i) 0, (ii) 1.5, (iii) 2.9474 mV, for the induction and recovery experiments. The top three panels trace $V_e(t)_{30,30}$, the excitatory soma voltage at grid-coordinate (30, 30) for induction (*black trace*) and recovery (*gray*). These time-series show the large-scale deterministic voltage trends as the cortex follows the tour i, ii, and iii trajectories marked on the Fig. 8.3 manifold. The step-like voltage jumps at the points of induction and emergence are very obvious in panels (i) ($\delta V_e^{\text{rest}} = 0$ mV) and (ii) ($\delta V_e^{\text{rest}} = 1.5$ mV). For tour iii, the transition region $1.8 \lesssim \lambda \lesssim 2.2$ is swamped by large-amplitude limit-cycle oscillations brought on by the low-frequency ($\lesssim 3$ Hz) Hopf instability predicted in Fig. 8.4.

In order to view the small-scale stochastic fluctuations about the deterministic trend, we also record ∂V_e , the voltage *differential* between two grid points separated by 4 mm,

$$\partial V_e(t) = V_e(t)_{30,34} - V_e(t)_{30,30}.$$

This subtraction eliminates all common-mode signals—such as dc trends or whole-of-cortex Hopf oscillations—thus leaving a residual fluctuation voltage that we interpret as being equivalent to the differential ECoG signal registered by a pair of cortical electrodes embedded in the cortex and separated by a distance of 4 mm (thus matching the electrode configuration used in the sheep experiments described in the next section). These differential voltages are plotted in the middle and bottom panels of Fig. 8.6. We see abrupt changes in fluctuation amplitude that are coincident with the dc transitions between top (awake) and bottom (anesthetized) branches. Counterintuitively, the simulation predicts *larger* ECoG fluctuation power in the

²The `convolve2` function is written by David Young, and available for download from www.mathworks.com/matlabcentral/fileexchange/22619-fast-2-d-convolution.

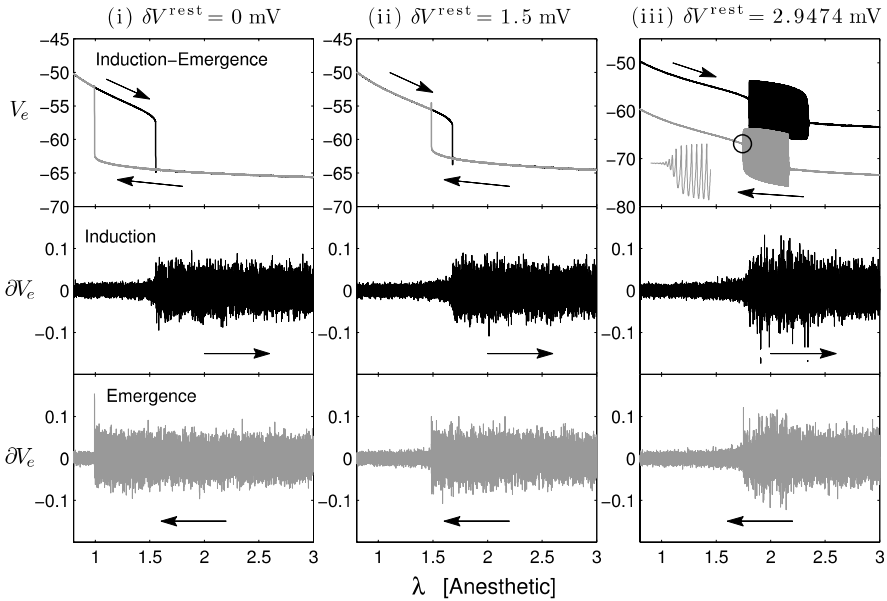

Fig. 8.6 Nonlinear simulation results for anesthesia induction and emergence at three settings for δV^{rest} : (i) 0 mV; (ii) 1.5 mV; (iii) 2.9474 mV; default IPSP rate-constant is set at $\gamma_i^0 = 85 \text{ s}^{-1}$. Two 10-min simulations are run at each δV^{rest} setting, with anesthetic factor λ either *increasing* linearly from 0.8 to 3.0 (induction, shown in *black*), or *decreasing* from 3.0 to 0.8 (emergence, in *gray*). Cortex is a 6- by 6-cm square of cortical tissue mapped to a 60×60 grid with toroidal boundary conditions; spatial resolution is $\Delta x = \Delta y = 1 \text{ mm}$; simulation time-step is $\Delta t = 0.4 \text{ ms}$. *Upper panels* plot the excitatory voltage V_e (in mV) at reference pixel (30, 30) near the center of the grid; *lower panels* plot $\partial V_e = V_e(30, 34) - V_e(30, 30)$ (mV), the voltage *difference* between pixel (30,34) and the reference pixel—this corresponds to the differential ECoG voltage measured between a pair of cortical electrodes spaced 4 mm apart. For clarity in *top-right panel*, emergence trace (*gray*) has been displaced vertically downwards by 10 mV. Both induction (*black*) and emergence (*gray*) trajectories display large-amplitude low-frequency global oscillations for anesthetic values $\lambda \approx 2$; this seizure-like instability arises from a Hopf bifurcation (see Fig. 8.4). The gray wavelet is a zoomed view of the *circled* (\circ) time-series showing exit from the “lake of instability” during emergence from anesthesia

low-voltage, low-firing bottom-branch (comatose) state than in the high-voltage, high-firing top-branch (conscious) state.

Of interest in the Fig. 8.6 graphs (panels (i), (ii)) is the clear hysteresis separation between the points of induction and emergence. We also observe a form of *dynamic* hysteresis in the Hopf instability in (iii): this arises, not from a jump between states (the locus of steady states for (iii) remains single-valued and continuous throughout), but from direction-sensitive delays in the birth and death of the seizure-like oscillations.

The differential ECoG fluctuations of Fig. 8.6 were Fourier analyzed in overlapping 10-s epochs in order to compute a time-series for $S(f)$, the short-time power

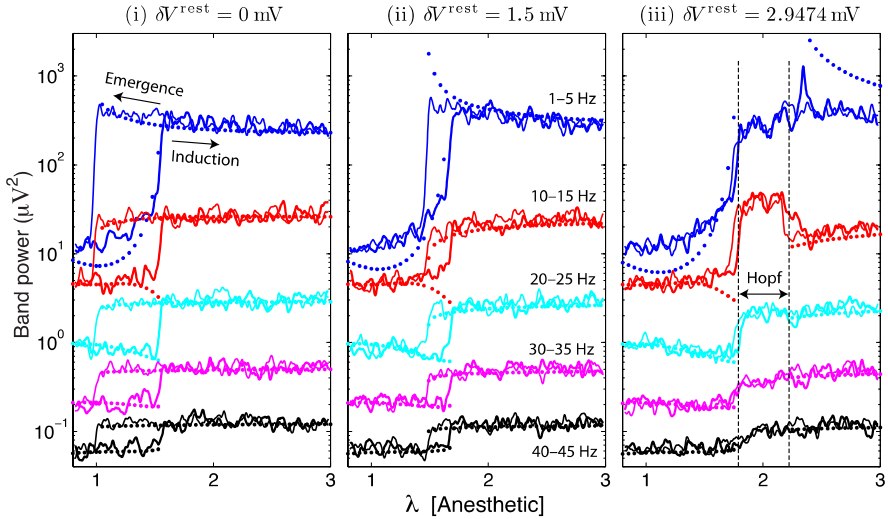

Fig. 8.7 Narrowband-power values computed for 10-min simulations for anesthesia induction (*thick curves*), and emergence (*thin curves*) at three values of excitatory voltage offset δV^{rest} : (i) 0 mV; (ii) 1.5 mV; (iii) 2.9474 mV; default IPSP rate-constant is set at $\gamma_i^0 = 85 \text{ s}^{-1}$. *Thick* and *thin* curves show the spectral analysis of the respective *black* and *gray* ∂V_e differential ECoG time-series displayed in Fig. 8.6. *Dotted points* are spectral predictions from (8.18). For trajectory (iii), stability analysis indicates a Hopf instability for $1.8 < \lambda < 2.2$, so linear spectral predictions are invalid here (dots suppressed). From top to bottom, frequency bands (in Hz) are 1–5 (*blue*); 10–15 (*red*); 20–25 (*cyan*); 30–35 (*magenta*); 40–45 (*black*). Each 10-min time-series was subsampled by a factor of 10 to give an effective sampling rate of 250 s^{-1} , analyzed in 10-s epochs with 90% overlap, then smoothed with a Whittaker filter (Eilers 1994)

spectral density (PSD), and hence derive the narrowband spectral power P ,

$$P^{(n)}(f_1, f_2) = \int_{f_1}^{f_2} S^{(n)}(f) df, \quad (8.20)$$

plotted in Fig. 8.7. Here, $S^{(n)}(f)$ is the PSD at epoch n , and $P^{(n)}$ is the narrowband power for that epoch. The *solid curves* in Fig. 8.7 are the values computed from the simulation results, and the *dotted curves* are theoretical predictions from the linear theory of (8.18). There is good agreement between theory and numerical experiment, except for the middle portion of panel (iii) where the dominant eigenvalue predicts a Hopf instability, thus rendering the linear spectrum invalid.

Figure 8.7 shows that most fluctuation activity occurs at the lowest frequencies (note the logarithmic power scale), with higher frequencies being strongly attenuated. All frequency bands exhibit a strong boost in narrowband power on induction of anesthesia, but only the lowest frequency band (1–5 Hz) also shows a power boost on emergence. The fact that higher-frequency activity shows little, if any, suppression at deeper levels of anesthesia (i.e., at larger λ) is a limitation of the model—we revisit this aspect in Sect. 8.3.3 following our investigation of ECoG spectra for propofol anesthesia in an adult sheep.

8.3 Induction of Propofol Anesthesia in a Sheep

During Aug–Nov 2002, colleagues³ at the University of Adelaide carried out a series of anesthesia studies on seven adult Merino sheep. The anesthetic agents tested were propofol, ketamine, and methohexital. Here we report on the analysis for propofol induction for one of these sheep, then compare the animal results against the mean-field cortical modeling described above.

8.3.1 Instrumentation

Under halothane anesthesia, the sheep was instrumented (as described by Voss et al. 2007; Ludbrook et al. 1996), then allowed to recover. This instrumentation enabled the researchers to record electrical brain activity, blood-flow rate, and propofol concentrations in both the arterial blood entering the brain, and in the cerebral effluent blood leaving the brain—the difference between these concentrations allows one to deduce the rate of propofol accumulation *in* the brain (see (8.21) below).

8.3.1.1 Monitoring Brain Activity

ECoG brain activity in the sheep was detected using a linear array of nine stainless steel electrodes implanted in the parasagittal plane of the cortex with the electrodes penetrating 1–2 mm into the outer layers of the cortical gray matter. Electrodes were spaced 2 mm apart, with alternate electrodes being connected to one of two EEG monitors (A-1000 Aspect Medical Systems), thus giving an effective inter-electrode recording separation of 4 mm. A network of passive divide-by-5 attenuators was mounted on the electrode circuit board to ensure that the ECoG signal did not overdrive the input stage of the EEG monitors. Sampling rate was set at 256 s^{-1} , and the ECoG voltages were recorded with a digital precision of 14 bits. We found that, in response to a step-change in dc voltage, the Aspect monitors exhibit an exponential decay to zero voltage with a time-constant of 1.0 s, so we deduce an effective high-pass filtering characteristic with corner frequency of $1/2\pi \approx 0.16 \text{ Hz}$ (this is the “all filters off” default behavior; no additional signal filtering was applied by the A-1000 monitor).

8.3.1.2 Drug Delivery and Blood Sampling

Propofol was administered intravenously as a 200-mg bolus delivered over a period of 2 min via injection into the blood-stream at the sheep’s femoral vein (in the thigh).

³G. Ludbrook, C. Grant, and R. Upton, from the Department of Anaesthesia and Intensive Care, University of Adelaide, Adelaide, South Australia, Australia. Experimental methods were approved by the Animal Ethics Committee of University of Adelaide.

Following commencement of drug injection, 1-mL samples of arterial and sagittal-sinus blood were taken every 15 s for 3 min, and then every minute out to 20 min. Samples were cooled and stored for subsequent off-line assay of propofol concentrations. These samples provide point estimates of the upstream and downstream drug concentrations [in μg propofol per mL of whole blood] for the blood-stream servicing the brain.

8.3.2 Determination of Propofol Concentration in the Brain

Within 10–20 heartbeats of propofol injection, the increased drug concentration would have been distributed throughout the arterial network, including the cerebral capillary system that provides blood flow to the brain. However, delivery of propofol from the capillary blood into the brain parenchyma, the presumed drug-effect site, is delayed by slow diffusive transport across the protective permeable membrane that acts as a blood–brain barrier. For propofol, the half-life for blood:brain equilibration is of the order of 2–4 min (Ludbrook et al. 1999; Olofsen et al. 2008). The propofol not taken up by the brain remains in the cerebral blood flow, and is drained via the sagittal sinus, the large vein at the top of the brain, for return to the heart and subsequent recirculation.

Because propofol is neither catabolized (Ludbrook et al. 1999) nor manufactured in the brain (i.e., no sinks or sources of propofol there), the rate of change of C_b [units: $\mu\text{g}/\text{mL}$], the drug concentration in the brain, will be proportional to the difference between the influx (arterial: C_{art}) and efflux (sagittal: C_{sag}) blood-flow concentrations. If the cerebral blood-flow (CBF) rate is Q [mL/min], and the effective blood volume drained by the sagittal sinus is V_b [mL], then a mass-conservation argument (also referred to as *mass balance*) leads to the following expression for the rate of drug uptake in the brain (Upton et al. 1988):

$$\frac{d}{dt}C_b(t) = \frac{1}{V_b}[C_{\text{art}}(t) - C_{\text{sag}}(t)]Q(t), \quad (8.21)$$

with the time-integral of the drug flux giving the brain concentration at any time t ,

$$C_b(t) = \frac{1}{V_b} \int_0^t [C_{\text{art}}(t') - C_{\text{sag}}(t')]Q(t') dt'. \quad (8.22)$$

In the sheep study, the cerebral blood flow Q was determined from the product of the flow velocity, measured via Doppler flowprobe, times the cross-sectional area of the blood vessel to which the probe was attached. The effective blood volume for the brain was taken to be $V_b = 75$ mL (Voss et al. 2007).

Figure 8.8 shows the distinct time courses for the measured and deduced propofol concentrations in one sheep experiment. The 2-min infusion of propofol (*solid-black bar*) commenced at time $t = 3$ min. The arterial propofol level (C_{art} : *black curve*) rises rapidly to reach its maximum at cessation of drug delivery at $t = 5$ min, while the venous propofol level (C_{sag} : *dashed-black*) rises more slowly to a broader peak; the resulting brain concentration (C_b : *thick-gray*), deduced from the accumulated

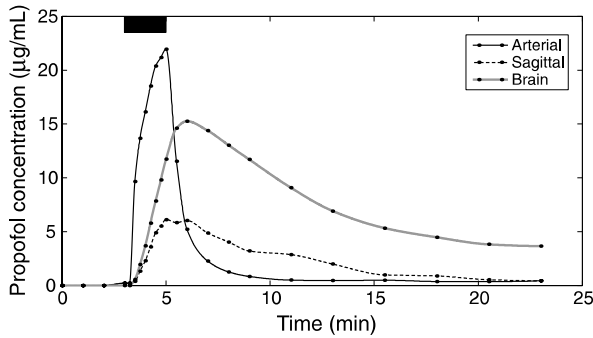

Fig. 8.8 Time course of propofol concentration as measured on *entry* to (*solid-black curve*: femoral artery), and *exit* from (*dashed-black*: sagittal sinus) the cerebral cortex of an adult sheep; and calculated concentration *in* the brain (*thick-gray curve*). The curves are smooth fits (piecewise cubic Hermite polynomial) to the concentration point-data (*black dots*). A 200-mg infusion of propofol was injected intravenously over a period of 2 min (indicated with *upper black bar*). The resulting ECoG brain activity for this sheep is shown in Figs. 8.9 and 8.10

$(C_{\text{art}} - C_{\text{sag}})$ influx-minus-outflux difference over time (see (8.22)), reaches its peak value of $15.26 \mu\text{g/mL}$ at $t = 6.0$ min, 1 min after completion of drug delivery, then declines slowly over the next 17 min.

We now examine the concomitant changes in electrical activity in the sheep cortex recorded during induction and recovery of propofol anesthesia.

8.3.3 Analysis of Sheep ECoG Spectrum

Each Aspect A-1000 EEG monitor recorded four channels of ECoG activity from the linear multielectrode array embedded on the cortical surface. An electrode at one end of the array served as a common reference for all channels. With an effective grid spacing of 4 mm, channels 1 through 4 registered the voltage differences developed over respective distances of 4, 8, 12, and 16 mm from the reference electrode. We found little qualitative difference between the time-series or spectral characteristics of the four channels, so we choose to present the analysis for channel-3 since it is marginally clearer and less “noisy” than the others.

After applying a second-order Butterworth notch filter to remove 50-Hz mains interference, we Fourier transformed the 25-min channel-3 ECoG time-series using the MATLAB `spectrogram` function (5-s epochs with 90% overlap, Hamming window), then smoothed the resulting frequency–time power spectrum by applying Whittaker smoothing (Eilers 1994) over both time and frequency.

In Figs. 8.9 and 8.10 we present bird’s-eye and perspective views of the spectrogram with a logarithmic (dB) mapping between ECoG power and displayed colormap. On the first spectrogram, we have superimposed the C_b brain-propofol trace (from Fig. 8.8) as a convenient reference. We see two surges in fluctuation power:

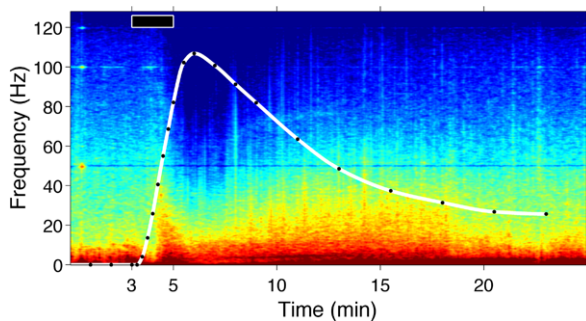

Fig. 8.9 ElectroCorticogram (ECoG) power spectrum for propofol induction of anesthesia in an adult Merino sheep. Three minutes into the recording, a 200-mg infusion of propofol was delivered over a period of 2 min (indicated with *upper black bar*). *White curve* shows smooth fit to calculated drug concentrations (*black dots*) in the brain. Propofol readings (in $\mu\text{g}/\text{mL}$) have been scaled by $\times 7$ for ease of display against the frequency-axis; peak concentration of $15.26 \mu\text{g}/\text{mL}$ occurred at $t = 6.0$ min, 1 min after cessation of drug infusion. Note the two biphasic surges in ECoG power: the first narrow peak ($4 < t < 5$ min) marks induction of anesthesia; the second, broader peak ($8 < t < 18$ min) corresponds to emergence. ECoG sample rate was 256 s^{-1} . (Signal deficit at 50 Hz is an artifact resulting from removal of mains interference)

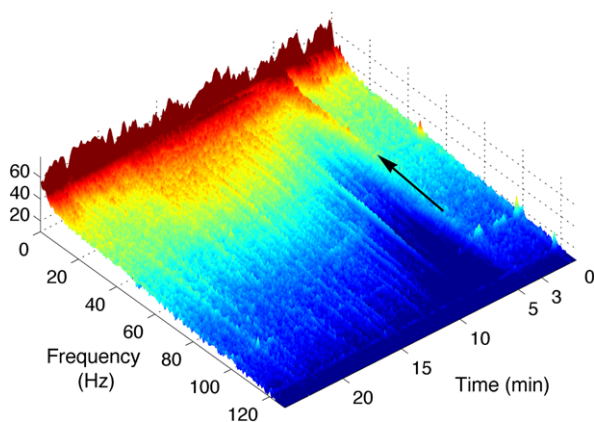

Fig. 8.10 Perspective surface view of ECoG spectrogram shown in Fig. 8.9 for induction of propofol anesthesia in an adult sheep. Power spectral density (*vertical axis*) carries units of $(\mu\text{V})^2/\text{Hz}$, expressed in dB. The inductive surge in brain activity at $t = 5$ min (*arrowed*) is immediately followed by steep decline, with activity suppression moving progressively toward lower frequencies. Minimum activity corresponds with maximum drug concentration at $t = 6$ min. Brain activity then recovers gradually, displaying a second biphasic surge that peaks at $t \sim 15$ min

the first peak occurs near $t = 5$ min as the level of propofol in the brain is rising rapidly during induction of anesthesia; the second, much broader peak develops later as propofol levels decline during the recovery phase. The presence of two biphasic power surges in the sheep ECoG is consistent with the dual peaks reported for EEG

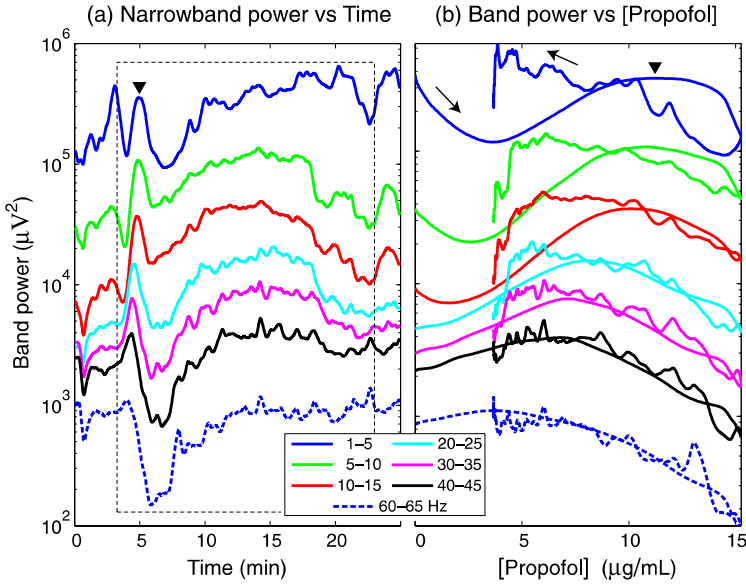

Fig. 8.11 Narrowband spectral power for propofol anesthesia plotted (a) versus time; and (b) versus propofol concentration in the brain. Black-triangle (\blacktriangledown) symbols in (a) and (b) mark the point of maximum low-frequency power during induction. These plots show integrated ECoG activity $\int_{f_1}^{f_2} S(f) df$ over the (f_1, f_2) frequency intervals listed in the legend; $S(f)$ is the power spectral density shown in the Fig. 8.10 spectrogram. All bands show a power surge during induction (around 5 min), and a second surge during recovery (around 15 min); for both peaks, higher-frequency activity tends to surge sooner. Consequently, hysteretic separation between induction and emergence peaks is strongest at the lowest frequencies (1–5 Hz), and disappears at the highest frequencies (e.g., 60–65 Hz)

recordings from human patients during induction–recovery cycling under propofol anesthesia (e.g., Kuizenga et al. 1998, 2001a).

To quantify the spectral changes during sheep anesthesia, we computed the narrowband spectral power in the same manner as we did earlier for the numerical simulations (see (8.20) and Fig. 8.7). In Fig. 8.11 we plot band power (averaged across all four ECoG channels to improve smoothing) (a) as a function of time, and (b) as a function of brain-propofol concentration.

As was the case for the mean-field simulations, Fig. 8.11 shows that most of the fluctuation power resides in the lowest frequencies, with a monotonic decrease in power as the frequency band increases. Also, all bands show two power surges: a brief surge during induction, and a broader peak during recovery. However, unlike the simulation results, deeper levels of anesthesia are associated with significantly diminished activity. Further, for both surges, higher-frequency activity tends to peak earlier so that the hysteresis separation between induction and emergence peaks is strongest for the lowest frequency bands, but seems to disappear at the highest frequencies.

8.4 Conclusion

In this chapter we have described a first-order phase-transition model for anesthesia that was first elucidated in a reduced two-variable adiabatic form in Steyn-Ross et al. (1999), and developed further in Steyn-Ross et al. (2001a, 2001b, 2003, 2004). Subsequent analysis of the full non-adiabatic model (Wilson et al. 2006) revealed the emergence of a low-frequency Hopf oscillation when the γ_i^{-1} IPSP time-constant is sufficiently prolonged, and we have demonstrated in the present chapter that the Hopf instability is most likely to emerge at enhanced levels of cortical activation (i.e., when δV_e^{rest} is raised).

However, the primary focus of this chapter is not so much the large-scale nonlinear cortical dynamics of Hopf oscillations, but rather the small-scale stochastic voltage fluctuations for a cortex transiting into anesthesia along constant- δV_e^{rest} trajectories that lie on the manifold of homogeneous steady states. Because anesthesia appears to be steplike, all-or-nothing phenomenon—the subject is either aware and responsive, or unaware and unresponsive—we have selected trajectories that traverse the region of multiple steady states, with the implicit assumption that LOC (loss of consciousness) corresponds to the abrupt transition from the high-firing upper branch to the low-firing lower branch. Also implicit in this choice of trajectory is the prediction that ROC (recovery of consciousness) will occur at a *lower* level of anesthetic concentration than that required to put the patient to sleep, and that this transition will also be sudden and switch-like, and not smoothly graduated. Thus we have a prediction that the subject’s cortical state will be history-dependent, with asymmetric induction and recovery paths.

This notion of a “true” hysteretic separation between drug concentrations at the LOC and ROC critical points is controversial, since it runs counter to accepted practice in PKPD (pharmacokinetic–pharmacodynamic) modeling in which rate-constants are adjusted to cancel the apparent hysteresis lag between changes in drug concentration (in the arterial blood) and the resulting changes in brain EEG response. Because of the ~ 2 -min diffusion time required for the anesthetic to cross the blood–brain barrier, the need for some lag adjustment between the *measurement site* (arterial blood supply) and the *effect site* (brain) to correct for site-displacement error is indisputable; but even after appropriate correction, our first-order phase transition picture suggests that some residual hysteresis will remain. Such hysteresis would give some protection against noise-induced multiple “bounces” between awake and asleep states.

The analysis of the ECoG and propofol concentration records for the Adelaide sheep (Sect. 8.3) provides some guidance. The very thorough instrumentation for blood monitoring meant that actual drug concentrations in the brain could be deduced on the basis of a simple mass-conservation (integrated influx minus outflux) argument, and no PKPD extrapolations to “null the hysteresis loop” were required. We should acknowledge that although the mass-conservation approach gives the propofol concentration in the *brain*, the actual concentration at the molecular *effect site* (presumably the membrane GABA-receptor proteins that control chloride-ion flow) remains unknown, so modeling of equilibration between bulk-brain versus receptor site may still be needed.

A second significant advantage provided by the sheep that is (normally) unavailable in human subjects is the direct access to the ECoG signal on the cortex itself rather than via its remote on-scalp proxy, the EEG. Not only is the ECoG signal unattenuated by scalp, skull, and cerebrospinal fluid, it is much less likely to be contaminated by EMG (electromyogram) and EOG (electrooculogram) muscle artifacts, so provides a clearer view of the state of the cortex. It is possible that there could be electrode-induced artifacts (e.g., from movement, electrochemistry, biological fouling) but these are likely to be very low-frequency effects, and we have made no attempt to model them.

Examination of the sheep ECoG narrowband spectra shows clear evidence of hysteresis effects, and these are most pronounced at the lowest frequencies. Unexpectedly, the hysteresis separation between induction and emergence paths seems to disappear at the higher frequencies ($\gtrsim 40$ Hz), and this is contrary to the mean-field prediction of hysteresis effects across all frequency bands. But because the sheep ECoG spectrum exhibits a steeply lowpass-filtered response, it is plausible that high-frequency hysteresis effects may have been swamped by inherent cortical noise.

Another point of difference between the continuum prediction and sheep measurement is the strong concentration-dependent attenuation of electrical activity that is evident in the sheep, but absent (except at the lowest frequency band) in the cortical model. This deficiency might be remedied by scaling back the noise intensity (as well as the overall subcortical drive) in proportion to anesthetic concentration to reflect drug-induced dampening of subcortical tone.

In modeling anesthesia, how significant is the choice of IPSP function? We have used a constant-height alpha-function (see (8.12)) whose area and time-to-peak increase proportionately to drug concentration, while other researchers have constructed a constant-height biexponential form whose time-to-peak is independent of drug concentration (Liley and Bojak 2005; Bojak and Liley 2005), or nearly so (Hutt and Longtin 2010). It would be interesting to establish what impact the various IPSP functional forms have on spectral characteristics and cortical stability.

We now comment briefly on two significant challenges for anesthesia modeling: the role of spatial interactions, and the puzzle posed by dissociative anesthetics.

During induction of anesthesia, is it reasonable to ignore interactions between different brain regions? The fact that commercial EEG depth-of-anesthesia devices (e.g., BIS monitor from Aspect Medical Systems; M-Entropy monitor from GE Healthcare) can give satisfactory performance using a *single* electrode pair whose on-scalp positioning is not particularly critical suggests that a single brain-area treatment (such as that presented in this chapter) is a reasonable first approximation, but this simplified approach ignores significant underlying neural structures such as the thalamus and the pacemaking role of strong cortico-thalamic feedbacks. The 19-channel quantitative EEG analysis by John et al. (2001) showed pronounced transient increases in fluctuation coherence across the cortex immediately prior to LOC, and again at ROC, indicating strengthened coupling across brain areas. A satisfactory model for anesthesia should be able to account for such observations.

To what extent can EEG and ECoG be used as a proxy for state of consciousness? The EEG spectral effects caused by inductive anesthetics such as propofol

and isoflurane are readily detected, since these bring on a form of enforced slow-wave sleep. But the REM-like unconscious state brought on by dissociative agents such as nitrous oxide, ketamine, xenon exhibits an EEG spectrum that seem to be indistinguishable from that of normal consciousness. Developing a predictive model for dissociative anesthesia would be a significant advance.

References

- Bojak I, Liley DTJ (2005) Modeling the effects of anesthesia on the electroencephalogram. *Phys Rev E* 71:041902
- Chaturvedi S, Gardiner CW, Matheson IS, Walls DF (1977) Stochastic analysis of a chemical reaction with spatial and temporal structures. *J Stat Phys* 17:469–489
- Eilers PHC (1994) Smoothing and interpolation with finite differences. In: Heckbert PS (ed) *Graphic gems IV*. Academic Press, San Diego, pp 241–250
- Foster BL, Bojak I, Liley DTJ (2008) Population based models of cortical drug response: insights from anaesthesia. *Cog Neurodyn* 2(4):283–296
- Franks NP, Lieb WR (1994) Molecular and cellular mechanisms of general anaesthesia. *Nature* 367:607–613
- Franks NP, Dickenson R, de Sousa SLM, Hall AC, Lieb WR (1998) How does xenon produce anaesthesia? *Nature* 396:324
- Fulcher BD, Phillips AJK, Robinson PA (2008) Modeling the impact of impulsive stimuli on sleep-wake dynamics. *Phys Rev E* 78(5):051920
- Guedel AE (1937) *Inhalational anesthesia: a fundamental guide*. Macmillan, New York
- Hutt A, Longtin A (2010) Effects of the anesthetic agent propofol on neural populations. *Cog Neurodyn* 4(1):37–59
- Hutt A, Schimansky-Geier L (2008) Anesthetic-induced transitions by propofol modeled by non-local neural populations involving two neuron types. *J Biol Phys* 34(3–4):433–440
- John ER, Prichep LS, Kox W, Valdés-Sosa P, Bosch-Bayard J, Aubert E, Tom M, diMichele F, Guginoi LD (2001) Invariant reversible QEEG effects of anesthetics. *Conscious Cogn* 10:165–183
- Kelly DD (1991) Sleep and dreaming. In: Kandel ER, Schwartz JH, Jessell TM (eds) *Principles of neural science*, 3rd edn. Prentice-Hall, Toronto, pp 792–804
- Kitamura A, Marszalec W, Yeh JZ, Narahashi T (2002) Effects of halothane and propofol on excitatory and inhibitory synaptic transmission in rat cortical neurons. *J Pharmacol* 304(1):162–171
- Kuizenga K, Kalkman CJ, Hennis PJ (1998) Quantitative electroencephalographic analysis of the biphasic concentration–effect relationship of propofol in surgical patients during extradural analgesia. *Br J Anaesth* 80:725–732
- Kuizenga K, Proost JH, Wierda JMKH, Kalkman CJ (2001a) Predictability of processed electroencephalography effects on the basis of pharmacokinetic–pharmacodynamic modeling during repeated propofol infusions in patients with extradural analgesia. *Anesthesiology* 95:607–615
- Kuizenga K, Wierda JMKH, Kalkman CJ (2001b) Biphasic EEG changes in relation to loss of consciousness during induction with thiopental, propofol, etomidate, midazolam or sevoflurane. *Br J Anaesth* 86:354–360
- Liley DTJ, Bojak I (2005) Understanding the transition to seizure by modeling the epileptiform activity of general anesthetic agents. *Clin Neurophysiol* 22(5):300–313
- Liley DTJ, Cadusch PJ, Wright JJ (1999) A continuum theory of electro-cortical activity. *Neurocomputing* 26–27:795–800
- Ludbrook GL, Upton RN, Grant C, Gray EC (1996) Brain and blood concentrations of propofol after rapid intravenous injection in sheep and their relationships to cerebral effects. *Anaesth Intensive Care* 24(4):445–452

- Ludbrook GL, Upton RN, Grant C, Martinez A (1999) Prolonged dysequilibrium between blood and brain concentrations of propofol during infusions in sheep. *Acta Anaesthesiol Scand* 43(2):206–211
- Molae-Ardekani B, Senhadji L, Shamsollahi MB, Vosoughi-Vahdat B, Wodey E (2007) Brain activity modeling in general anesthesia: enhancing local mean-field models using a slow adaptive firing rate. *Phys Rev E* 76(4):041911
- Olofsen E, Sleight JW, Dahan A (2008) Permutation entropy of the electroencephalogram: a measure of anaesthetic drug effect. *Br J Anaesth* 101(6):810–821
- Phillips AJK, Robinson PA (2007) A quantitative model of sleep-wake dynamics based on the physiology of the brainstem ascending arousal system. *J Biol Rhythms* 22(2):167–179
- Rennie CJ, Wright JJ, Robinson PA (2000) Mechanisms for cortical electrical activity and emergence of gamma rhythm. *J Theor Biol* 205:17–35
- Robinson PA, Rennie CJ, Wright JJ (1997) Propagation and stability of waves of electrical activity in the cerebral cortex. *Phys Rev E* 56:826–840
- Robinson PA, Rennie CJ, Wright JJ, Bourke PD (1998) Steady states and global dynamics of electrical activity in the cerebral cortex. *Phys Rev E* 58:3557–3571
- Robinson P, Rennie C, Phillips A, Kim J, Roberts J (2010) Phase transitions in physiologically-based multiscale mean-field brain models. In: Steyn-Ross DA, Steyn-Ross ML (eds) *Modeling phase transitions in the brain*. Springer series in computational neuroscience, vol 4. Springer, Berlin, pp 179–201
- Steyn-Ross ML, Steyn-Ross DA, Sleight JW, Liley DTJ (1999) Theoretical electroencephalogram stationary spectrum for a white-noise-driven cortex: evidence for a general anesthetic-induced phase transition. *Phys Rev E* 60:7299–7311
- Steyn-Ross DA, Steyn-Ross ML, Wilcocks LC, Sleight JW (2001a) Toward a theory of the general anesthetic-induced phase transition of the cerebral cortex: II. Stochastic numerical simulations, spectral entropy, and correlations. *Phys Rev E* 64:011918
- Steyn-Ross ML, Steyn-Ross DA, Sleight JW, Wilcocks LC (2001b) Toward a theory of the general anesthetic-induced phase transition of the cerebral cortex: I. A statistical mechanics analogy. *Phys Rev E* 64:011917
- Steyn-Ross ML, Steyn-Ross DA, Sleight JW, Whiting DR (2003) Theoretical predictions for spatial covariance of the EEG signal during the anesthetic-induced phase transition: increased correlation length and emergence of self-organization. *Phys Rev E* 68:021902
- Steyn-Ross ML, Steyn-Ross DA, Sleight JW (2004) Modelling general anaesthesia as a first-order phase transition in the cortex. *Prog Biophys Mol Biol* 85:369–385
- Steyn-Ross DA, Steyn-Ross ML, Sleight JW, Wilson MT, Gillies IP, Wright JJ (2005) The sleep cycle modelled as a cortical phase transition. *J Biol Phys* 31:547–569
- Steyn-Ross DA, Steyn-Ross ML, Wilson MT, Sleight JW (2006) White-noise susceptibility and critical slowing in neurons near spiking threshold. *Phys Rev E* 74:051920
- Steyn-Ross ML, Steyn-Ross DA, Wilson MT, Sleight JW (2007) Gap junctions mediate large-scale Turing structures in a mean-field cortex driven by subcortical noise. *Phys Rev E* 76:011916
- Steyn-Ross ML, Steyn-Ross DA, Wilson MT, Sleight JW (2009) Modeling brain activation patterns for the default and cognitive states. *NeuroImage* 45:298–311
- Steyn-Ross DA, Steyn-Ross ML, Wilson MT, Sleight JW (2010a) Phase transitions in single neurons and neural populations: Critical slowing, anesthesia, and sleep cycles. In: Steyn-Ross DA, Steyn-Ross ML (eds) *Modeling phase transitions in the brain*. Springer series in computational neuroscience, vol 4. Springer, Berlin, pp 1–26
- Steyn-Ross ML, Steyn-Ross DA, Wilson MT, Sleight JW (2010b) Cortical patterns and gamma genesis are modulated by reversal potentials and gap-junction diffusion. In: Steyn-Ross DA, Steyn-Ross ML (eds) *Modeling phase transitions in the brain*. Springer series in computational neuroscience, vol 4. Springer, Berlin, pp 271–299
- Strogatz SH (2000) *Nonlinear dynamics and chaos*. Westview Press, Cambridge
- Upton RN, Mather LE, Runciman WB, Nancarrow C, Carapetis RJ (1988) The use of mass balance principles to describe regional drug distribution and elimination. *J Pharmacokinetic Biopharm* 16(1):13–29

- Voss LJ, Ludbrook G, Grant C, Upton R, Sleight JW (2007) A comparison of pharmacokinetic/pharmacodynamic versus mass-balance measurement of brain concentrations of intravenous anesthetics in sheep. *Anesth Analg* 104(6):1440–1446
- Wilson MT, Steyn-Ross ML, Steyn-Ross DA, Sleight JW (2005) Predictions and simulations of cortical dynamics during natural sleep using a continuum approach. *Phys Rev E* 72:051910
- Wilson MT, Sleight JW, Steyn-Ross DA, Steyn-Ross ML (2006) General anesthetic-induced seizures can be explained by a mean-field model of cortical dynamics. *Anesthesiology* 104:588–593
- Wilson MT, Steyn-Ross ML, Steyn-Ross DA, Sleight JW, Gillies IP, Hailstone DJ (2010) What can a mean-field model tell us about the dynamics of the cortex. In: Steyn-Ross DA, Steyn-Ross ML (eds) *Modeling phase transitions in the brain*. Springer series in computational neuroscience, vol 4. Springer, Berlin, pp 223–242
- Wright JJ, Robinson PA, Rennie CJ, Gordon E, Bourke PD, Chapman CL, Hawthorn N, Lees GJ, Alexander D (2001) Toward an integrated continuum model of cerebral dynamics: the cerebral rhythms, synchronous oscillation and cortical stability. *Biosystems* 73:71–88

Chapter 9

EEG Modeling in Anesthesia: A New Insight into Mean-Field Approach for Delta Activity Generation

B. Molaee-Ardekani, M.B. Shamsollahi, and L. Senhadji

9.1 Introduction

The pioneer works of Wilson and Cowan in early 1970s, introducing local mean-field representation of the activity of ensembles of neurons, has opened a new avenue in mathematical description of the electrical functioning of neural tissues in mesoscopic levels. In the last two decades, progress in neuroscience has contributed to enhance mesoscopic models by including new mechanisms, and to employ them to study different types of brain activities in different brain areas. Nowadays, mesoscopic models have been developed both for normal and abnormal representation of neural populations. For instance, Jansen group has proposed a lumped-parameter model of the visual cortex to study the generation of evoked potentials (Jansen et al. 1993; Jansen and Rit 1995). Wendling et al. (2002, 2005) have studied different phases of epilepsy from pre-ictal to ictal in hippocampus. They have also hypothesized a mechanism by which low-amplitude high-frequency chirp-like activities are generated at the onset of seizure in cortical areas (Molaee-Ardekani et al. 2010a). Suffczynski et al. (2004) have investigated the mechanisms of transition between normal EEG activity and epileptiform paroxysmal activity using a model of thalamocortical circuits, and finally, Robinson and coworkers have studied different normal and abnormal EEG rhythms such as slow-wave sleep, alpha waves, low-gamma waves and epileptic seizures (Rennie et al. 2000; Robinson et al. 2002; Robinson et al. 2003; Deco et al. 2008).

Mean-field models have also been used in the context of anesthesia. In last few years, different aspects of anesthesia mechanisms and their influences on brain activities have been investigated theoretically by several groups such as Steyn-Ross et al. (2004), Liley and Bojak group (Bojak and Liley 2005; Liley and Bojak 2005),

B. Molaee-Ardekani (✉)

LTSI, University of Rennes 1, Inserm U642, Rennes 35000, France

e-mail: molaee-ardekani@ieee.org

Molaee-Ardekani et al. (2007), and Hutt and Longtin (2009). Most of the models developed by these groups are in fact refined versions of a generic model that was firstly introduced by Liley et al. (2002) in the context of mean-field theory of electrocortical activities.

Research conducted by Steyn-Ross et al. (2001a, 2001b, 2002, 2004) was the first attempt to use the generic Liley et al. model for reproducing electrical activities of the neocortex in different depths of anesthesia. Steyn-Ross et al. had a hypothesis to describe why gradual increase of an anesthetic drug produces a sudden transition between awareness and unconsciousness. They referred to the influence of anesthetic drugs on prolongation of IPSPs due to the enhancement (prolongation) which is seen on the GABA_A neurotransmitter by holding the chloride ion channel open longer and allowing more Cl⁻ to enter the postsynaptic neuron. To incorporate this effect of anesthetics into the model, the biexponential function of IPSP response to a Dirac delta function was prolonged by a λ factor when anesthesia deepened. Calculating equilibrium solutions of the Steyn-Ross et al. model as a function of anesthetic effect (λ) revealed that the model may have one or three equilibrium solutions. These equilibrium solutions may produce three branches on an S-bend shape. Basically, the top and the bottom branches are stable, whereas the middle branch is unstable. This configuration provides the possibility of two phase transitions between the top and the bottom branches in a hysteresis path during induction of anesthesia and emergence from anesthesia. Indeed, according to the Steyn-Ross et al. model, the amounts of drug concentrations at which the patient loses his consciousness and returns to consciousness are not identical. As indicated in Fig. 9.1 loss of consciousness (LOC) occurs in a higher drug concentration than return of consciousness (ROC).

In the Steyn-Ross et al. model, both phase transitions at LOC and ROC are accompanied with an increase followed by a decrease in the amplitude of the output EEG signal. This amplitude variation is also observed in real EEG signals especially in the beginning of anesthesia induction, and it is referred to as biphasic response of the EEG (Kuizenga et al. 1998, 2001a, 2001b). Steyn-Ross et al. related this biphasic response with the amplitude variation that is observed in the model at LOC or ROC.

According to the Steyn-Ross et al. model, in the waking and anesthesia, the equilibrium solution of the model is located somewhere on the top and the bottom branches, respectively. The eigenspectrum corresponding to an equilibrium solution on the top branch has higher frequency components than the eigenspectrum corresponding to an equilibrium point on the bottom branch. Basically, this is in accordance with the tendency of changing frequency components of the EEG before and after anesthesia. However, a real EEG power spectrum in waking state is a bit narrower than what is obtained in the Steyn-Ross et al. model. In the Steyn-Ross et al. model, one can also find some eigenspectra with resonance frequency at about 12 Hz. Steyn-Ross et al. suggested that this resonance frequency might be related to alpha and spindles activities that appear in sedation and light anesthesia.

In 2005 a newer version for mean-field models in the context of anesthesia was introduced by Bojak and Liley (2005). This model had more fidelity with physiological properties of neural cells in the brain especially in terms of expressing IPSP

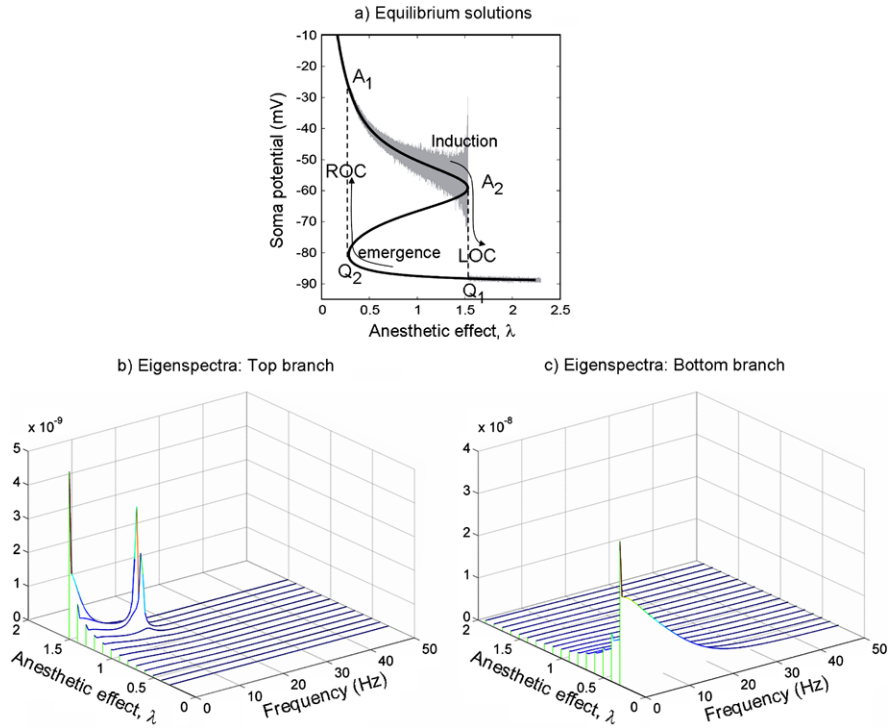

Fig. 9.1 (a) Steady states for h_e as a function of anesthetic effect λ in the Steyn-Ross et al. model. Induction and emergence paths are indicated by *two arrows*. Dashed lines indicate the location where phase transitions occur (LOC and ROC points). A time series of excitatory soma voltage h_e (in gray) is shown along the equilibrium curve for induction into unconsciousness. The amplitude of this time series increases gradually and then decreases abruptly when the phase transition occurs (biphasic response). [Modified with author permission from Fig. 7.8 of Steyn-Ross (2002).] (b, c) Eigenspectra corresponding to linearized equations about their steady states in the top branch and bottom branch as a function of λ . Eigenspectra in the top branch are wider than those in the bottom branch. Some eigenspectra corresponding to the top branch contain a resonance frequency in the alpha band (~ 12 Hz)

and EPSP functions. The Bojak–Liley model was a 2D brain model and a subtle mixture of homogeneous and non-homogeneous conditions were considered for its characterization. Indeed, while Bojak and Liley (2005) numerically simulated the model on a grid to obtain a spatial time series of cortical signals, their analytical analyses were performed in a homogeneous condition for a fixed spatial frequency at $k = 1.24 \text{ cm}^{-1}$. The 37 free parameters of the model could be set automatically to some values in a given physiological range. Bojak and Liley introduced 73454 valid sets of parameters for their model. A randomly generated set of parameters was marked ‘valid’ if the eigenspectrum of the EEG signal corresponding to that set could fulfill some criteria relating to bandwidths and power ratios of the delta, theta and alpha bands.

Although the basic structure of the Bojak–Liley model is almost the same as the basic structure of the Steyn-Ross et al. model, the working modes of these two models are different to reproduce cortical activities in different depths of anesthesia. Indeed, Bojak and Liley had another hypothesis regarding the mechanism by which anesthetics affect cortical activities. Steyn-Ross et al. had asserted that LOC and ROC occur in a hysteresis path in relation with two different phase transitions in two different drug concentrations. On the other hand, Bojak and Liley declared that such a phase transition is not observed in real experimental data. They argued that anesthetics reduce the firing rate of spontaneous action potentials in a relatively smooth dose-dependent manner, and as a result, mean membrane potential of excitatory and inhibitory populations do not change abruptly in response to a slight increase or decrease of anesthetic drug concentration. This argument could be supported by real electrical recording from cortical neural cells before and after administration of anesthetics (Antkowiak 1999), however, this argument did not have the answer to this question that why ROC and LOC occur in different doses of anesthetics.

The biphasic response of EEG could also be generated in the Bojak–Liley model, however, not in a hysteresis path. Not all the 73454 sets of parameters could lead to the biphasic response. Bojak and Liley divided these sets of parameters into two groups. Group I could show a biphasic power rise in simulated EEG signals, whereas group II could not show a strong biphasic response. The criterion for this division was the ratio of the output EEG signal power at $c = 0.243$ mM saline aqueous isoflurane concentration (equivalently $c = 1.17$ vol.% isoflurane or 1 MAC for 40-year human) and at $c = 0$ mM. If this ratio was greater than 1.4, the corresponding set of parameter was classified as a set with strong biphasic power rise. Out of entire 73454 sets of parameters, 86 sets exhibited the biphasic response. Figure 9.2 illustrates some spectral features of the model output EEG signal for one of these 86 sets of parameters. Figure 9.2a,b shows eigenspectra and total power of the model output EEG in different isoflurane concentrations. The total power at $c = 0.243$ mM is greater than 1.4 times the total power at $c = 0$ mM. Relative power ratios of delta, theta and alpha bands with respect to the total EEG power are illustrated in Fig. 9.2c. For a low-valued drug concentration most of the EEG power is in the alpha band. When the drug concentration increases a bit (e.g. at $c = 0.4$ mM), the theta band becomes the dominant band. Finally, for a high-valued drug concentration, the delta band has the biggest power among other bands.

9.2 Requirements for an Enhanced Model

In the previous section, we introduced two well-known mean-field models in the context of anesthesia. Although many of anesthesia actions on brain activities such as slowing EEG waves under the effect of anesthesia can be described by these models, there are still some rooms for improving these models. In this section, we present some effects of anesthesia on brain activities that had been considered with less degrees in the two aforementioned models. The new model, presented in Sect. 9.3, tries to take into account some of these effects.

Fig. 9.2 (a) EEG eigenspectra in the Bojak and Liley model for different isoflurane concentrations from 0 to 0.8 mM. These eigenspectra correspond to a set of parameters in group I (the group with strong biphasic response). (b, c) Total EEG power and power ratios of delta, theta and alpha bands in different drug concentrations for the same set of parameters used in panel (a)

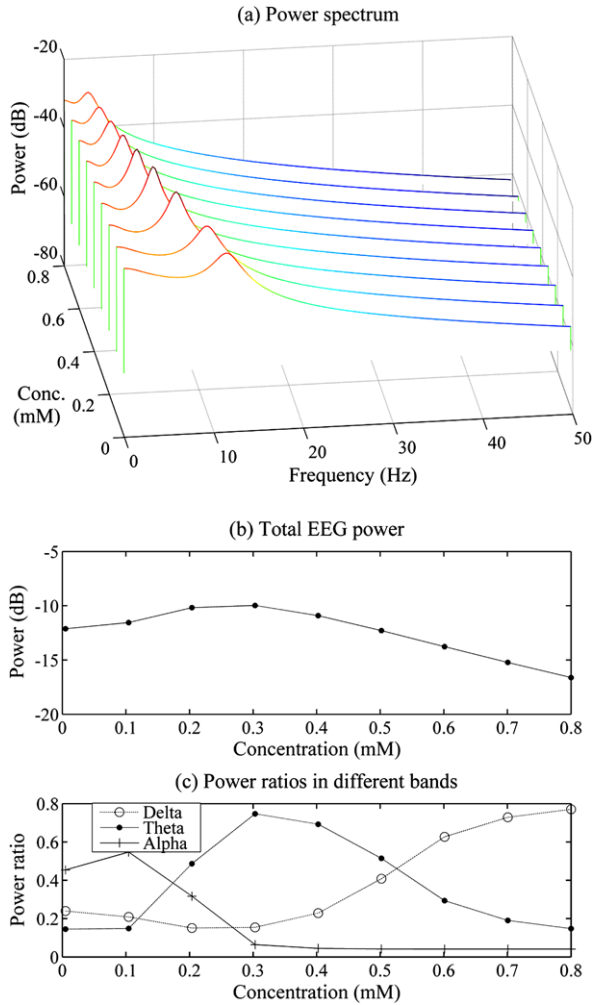

9.2.1 High-Amplitude Delta Waves

To our knowledge, the EEG power does not reduce a lot in the induction of anesthesia just after the LOC point (Schwender et al. 1998; Constant et al. 2005; Molaee-Ardekani et al. 2006). In contrary, in the Steyn-Ross et al. model, the power of the output EEG signal suddenly drops in the induction phase after the phase transition at LOC point. Similarly, the same behavior can be observed, more or less, in the Bojak–Liley model. For a set of parameters that belongs to group II, the EEG power decreases gradually with anesthesia, and for a set of parameters in group I, the power decreases a lot after its maximal value at about 1 MAC.

Bojak and Liley (2005) show that there is a good compatibility between total powers of real and simulated EEGs (corresponding to group I) below 1 MAC

(1.2 vol.%). Beyond this range, the total power of simulated EEG signal starts to decrease and even becomes less than the EEG power at 0 MAC. In reality, this high reduction of EEG power can only be observed if the EEG pattern changes from regular high-amplitude slow-wave activities in the delta band to burst suppression, which is not the case in the Bojak–Liley model. In addition, maximization of total EEG power of simulated data at 1 MAC is claimed to be related to the biphasic effect introduced by Kuizenga et al. (1998), whereas the real EEG signals that are used in this study for model validation purposes are recorded in stabilized concentrations at 0, 0.3, 0.6, 0.9 and 1.2 vol.% isoflurane. As we will show in Sect. 9.2.3, the entity of the biphasic effect that Kuizenga et al. (1998, 2001a, 2001b) introduce basically originates from rapid changes of anesthetic drug concentration, and should not be mixed with a stabilized biphasic effect.

9.2.2 Two States Rather than One Single State

A survey of neuroscience related journals shows that anesthetic agents reduce the activity of the brain in a pulsating manner (Antkowiak and Heck 1997; Mahon et al. 2001; Kasanetz et al. 2002). Intra and extra cellular recordings show that neurons have short periods of firing separated by silence phases. Some of them may alternate synchronously between the firing phase (up state) and the silence phase (down state). The mean histogram of membrane potentials of these cells includes two distinct peaks one in a high potential (e.g., -57 mV) and one in a low potential (e.g., -75 mV) (Destexhe et al. 2001; Steriade et al. 2001; Rudolph et al. 2005). The reason for this is that during firing episodes, neural cells have high membrane potentials and their firing rates are almost equal to those before the application of anesthetics (Antkowiak and Heck 1997; Antkowiak and Helfrich-Forster 1998), and during silence episodes they have low membrane potentials and do not usually fire.

Surprisingly, in a given small brain area there is a correlation between synchronous alternations of neural cells (between the up and down states) and the EEG signal that is recorded in that area. The result of this correlation and synchronous firing of neural cells is the generation of a high-amplitude slow-wave EEG signal on the scalp. Figure 9.3 illustrates one example for in-phase oscillations between the EEG and intracellular signals. Interested readers are recommended to study these activities in detail in Contreras and Steriade (1995), Pare et al. (1998), Amzica and Steriade (2002).

Saying that the EEG is in-phase with intracellular activities of neural cells that switch to the up and down states conveys the meaning that the EEG is also related to the up and down states. As a result, from the modeling view point, it can be mentioned that the same neuronal mechanisms that cause neural cells switch to the up and down states during anesthesia should be implemented, in a dual way, in mean-field models to generate the EEG. This statement is also supported by a research conducted by Fujisawa et al. (2006). They declared that single neurons

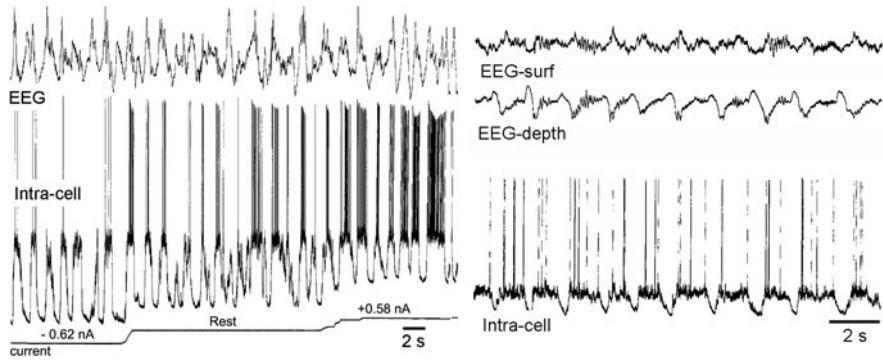

Fig. 9.3 Relation (in-phase oscillations) between spontaneous synaptic activity under ketamine-xylazine anesthesia and depth and surface EEG signals. Simultaneous surface cortical EEG and intracellular recording of a deep pyramidal neuron. This neuron was recorded at various voltages induced by current injections. [Modified with permission from Fig. 4 of Pare et al. (1998)]

possess some internal firing states (hereafter, ‘mode’ is used instead of ‘state’ to prevent ambiguities with the up state and the down state) that are coherent in adjacent neurons. Fujisawa et al. (2006) declared that an internal mode of a single cell in a network may represent the working mode of the entire network. As a result, it is not unlikely to say that the internal model of a single cell may determine the characteristics of the EEG.

A comparison between different firing patterns of neural cells in different working states of the brain (Steriade et al. 2001; Weyand et al. 2001) and the five internal modes that have been represented in Fujisawa et al. (2006) lead us to conclude that anesthesia changes a higher-indexed internal mode to a lower-indexed internal mode. These different internal modes are conceptually illustrated in Fig. 9.4 by some artificially made neural cell membrane potentials and histograms. The histograms corresponding to the first three internal modes have only one peak in a low potential. The fourth mode has a histogram with two peaks (corresponding to the up and down states), whereas the last mode has a histogram with one peak in a high potential. Mean firing rates of neural cells increase with the index of internal modes.

9.2.3 Biphasic Response Is a Temporal Response

The biphasic response of the EEG that Kuizenga et al. (1998, 2001a, 2001b) introduce is related to a rapid change of anesthetic drug concentration in induction or emergence phase of anesthesia. The manner of changing the dose of an anesthetic drug may influence the characteristics of the EEG signal and its biphasic response. For example, the time it takes to change a drug concentration from a stabilized value to another and the difference between the two values influence the biphasic response. The speed of administration of an anesthetic drug may even change the concentration in which the biphasic response is maximal; therefore, a fixed drug

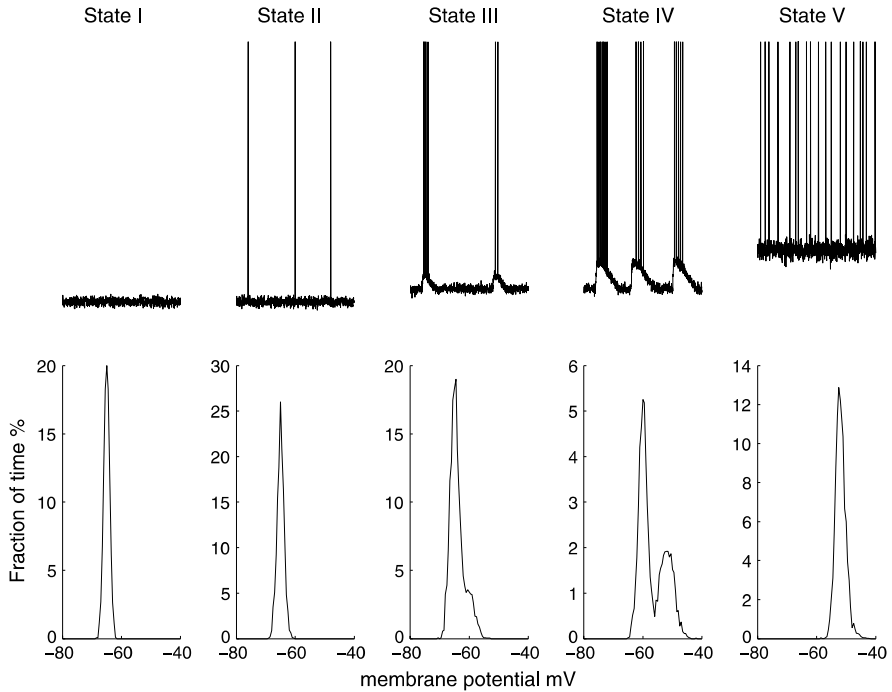

Fig. 9.4 Some examples of internal states (modes) of single neurons that can determine the working mode of the network. State I: neural cells do not fire for 10 s. State II: single spikes are observed on a background activity. State III: a mixture of silence and burst episodes. State IV: the same as the previous state, however, with different bursts characteristics. State V: regular spiking

concentration value cannot be corresponded to the biphasic power rise response. Figure 9.5 shows EEG amplitudes obtained from two patients when propofol is infused with different speeds in an aperiodic manner. The first two infusions have almost the same speed and they are faster than the third infusion. Each infusion process is followed by two EEG amplitude peaks: one when the infusion process starts and one when the infusion ends. Peaks amplitudes and their relating drug concentrations may vary according to the correspondences of the peaks to starting or to ending phases of infusion processes. In addition, the speed of infusion may also change the peak amplitude and its corresponding drug concentration. Interestingly, even if the infusion is repeated for a patient with, more or less, the same infusion parameters (e.g., the first and the second infusions shown in Fig. 9.5), characteristics of the biphasic responses may be different because of the past experience (history) that the patient has in receiving anesthetics.

The biphasic response is not only confined to rapid changes of drug concentration in transitions from waking to anesthesia and vice versa (i.e., loss of consciousness (LOC) and return of consciousness (ROC)). Any rapid change in drug concentration during anesthesia may induce a biphasic response. In addition, the characteristics of biphasic responses are not identical for all EEG sub-bands (Kuizenga et al. 1998).

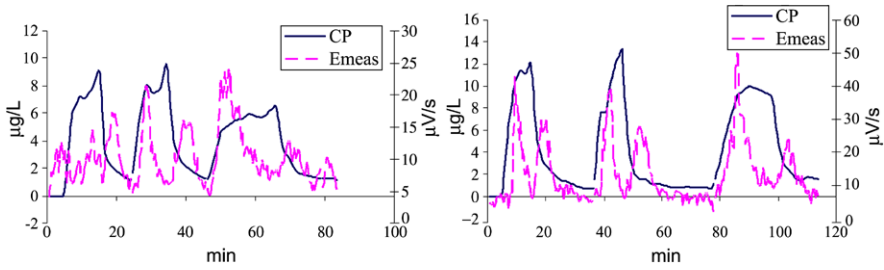

Fig. 9.5 Response of the EEG amplitude to sudden administrations/stops of propofol on two patients. Administration of propofol is repeated three times during ~ 1.5 – 2 hours. The initial perfusion is performed at the rate of $25 \text{ mg}\cdot\text{kg}^{-1}\cdot\text{h}^{-1}$ for 10 minutes. This fast initial perfusion is followed by another perfusion at the rate of $22 \text{ mg}\cdot\text{kg}^{-1}\cdot\text{h}^{-1}$ for 10 minutes. Finally, the last perfusion is performed slowly at the rate of $12.5 \text{ mg}\cdot\text{kg}^{-1}\cdot\text{h}^{-1}$ for 20 minutes. (Solid line) Real values of propofol concentration in the blood. (Dashed line) EEG amplitude in the 11–15 Hz band. [Data provided by Dr. Karel Kuizenga]

Figure 9.6 is an example to show how delta, theta, alpha and beta bands may have their own biphasic characteristics when desflurane concentration changes rapidly from a stabilized value to another. In this example, EEG is recorded in a child in the age of 8 years, and desflurane changes from 2 to 1 MAC at $t = 1$ min, and then from 1 to 0.5 MAC at $t = 10$ min (see Wodey et al. 2005; Molaee-Ardekani et al. 2010b) for a detailed description of the protocol of EEG recording).

What can be understood from all above-mentioned characteristics of the biphasic response is that the biphasic response is a complex transient response of the brain to rapid changes of an anesthetic drug concentration. Basically, characteristics of EEG signals at a given drug concentration in a steady-state condition and in a transient condition (such as in the biphasic response) are not identical. This implies that characteristics of those mean-field models that are designed to reproduce EEG signals in a steady-state condition should not be evaluated by the information that is obtained from the brain in a transient mode.

9.2.4 The Alpha Resonance Frequency Does not Shift to Theta and Delta Bands

It is well known that, in waking state if the eyes are closed, an activity in the alpha band appears in the EEG signal. One of the key features in the Bojak–Liley model is the existence of an alpha resonance frequency in reproduced EEG signals in waking state when the drug concentration is zero. As shown in Fig. 9.2a when drug concentration increases, the alpha resonance frequency moves to lower frequencies and enters into the theta and delta bands. To our knowledge, alpha resonance frequency does not move gradually toward theta and delta bands when anesthesia deepens. In response to deepening the anesthesia, although alpha resonance frequency decreases, it does not go below ~ 7 Hz. Indeed, when the alpha peak

Fig. 9.6 (Top) An EEG signal and its powers in delta (0.1–4 Hz), theta (4–7 Hz), alpha (8–12 Hz) and beta + gamma (> 15 Hz) bands. The EEG is recorded in a child at the age of 8 years old. Desflurane varies from 2 MAC to 1 MAC and then to 0.5 MAC during 20 minutes. (Bottom) Total EEG power and relative EEG powers in delta, theta, alpha and beta + gamma bands. Absolute and relative powers in different bands show that biphasic responses are not identical in all EEG sub-bands. In addition, biphasic responses are influenced by initial and final concentration values that are set for each variation of drug concentration

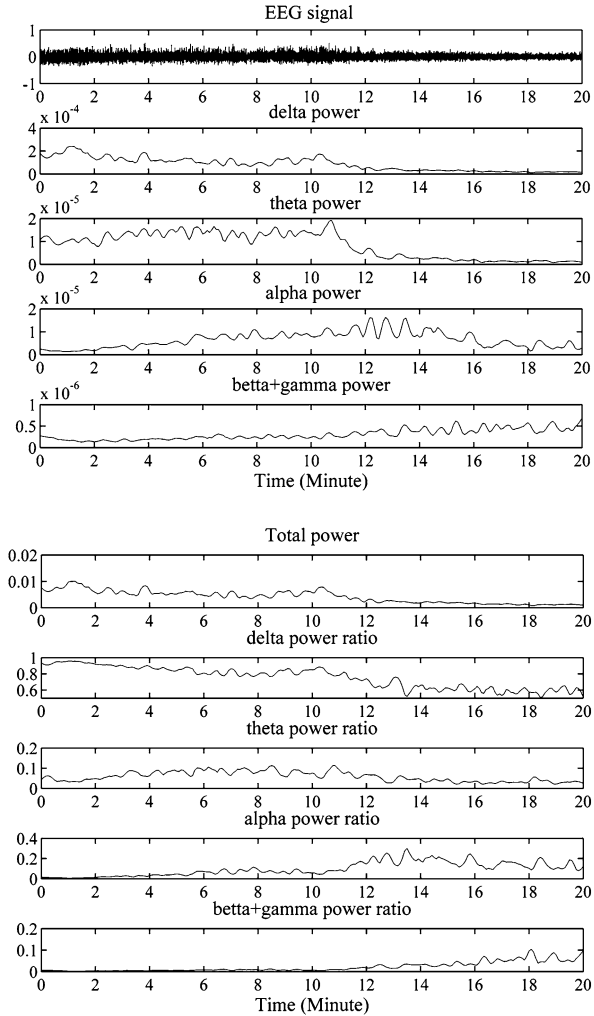

resonance frequency decreases a bit, its amplitude also decreases until it vanishes in deep anesthesia. In parallel, theta and delta powers increase a bit, as if alpha and theta powers are two sides of a seesaw. In the Bojak–Liley model, when anesthesia deepens, the amplitude of the resonance peak increases gradually, and it becomes maximal in the theta band where it is declared as the biphasic response of EEG at 1 MAC.

9.3 The Enhanced Model

In 2007, a newer version of mean-field models in the context of anesthesia was introduced by Molaee-Ardekani et al. (2007). In this paper authors tried to address

some of the mentioned limitations in the previous section. The basic structure of this model, which is called hereafter the enhanced model, was taken partly from the Steyn-Ross et al. model and partly from the Bojak–Liley model. In addition, a slow ionic mechanism was also added into the basic structure of the enhanced model. The enhanced model includes two neural populations: excitatory pyramidal cells and inhibitory interneurons. The excitatory population is under the direct influence of the slow ionic mechanism via its corresponding Wilson–Cowan sigmoid function (Wilson and Cowan 1972, 1973). Indeed, the sigmoid function was redefined to be not only a function of the mean membrane potential of excitatory population, but also a function of the activity of the slow ionic mechanism. This modification can bring in the model the adaptation of firing rates of neural populations to slow ionic activities in the brain. Under the effect of an anesthetic drug the slow mechanism may lead neural populations to alternate between the up and down states. This can resolve the first two limitations that were mentioned in the previous section firstly because neural populations can switch to the up and down states, secondly because the frequency of this switching is in the delta-band range (0–4 Hz). In fact, alternating neural populations between up and down states in the delta band can generate high-amplitude, low-frequency EEG signals in anesthesia. The enhanced model and its two pioneer models have different interpretations from the biphasic response. Biphasic responses at LOC and ROC are not reproduced in the enhanced model because the authors were thinking that these biphasic responses are related to the transient response of the brain to a fast varying anesthetic. They mentioned that their mean-field model is designed for an equilibrium condition so transient characteristics of real EEG signals should not be compared with the simulated EEG signals in this model.

This model does not produce the alpha resonance in the waking period. Instead, a wide-band background EEG activity substitutes the alpha activity. This issue will be discussed in more detail in Sect. 9.6.2. In the following of this section we firstly describe neurophysiologic reasons that a slow ionic mechanism was included in the enhanced model. Then, we present the structure of the enhanced model and the slow ionic mechanism in detail.

9.3.1 Neurophysiologic Reasons for Inserting a Slow Ionic Mechanism

As synaptic receptors may respond differently to an external input in different potentials, ion-channels may also have different dynamic characteristics during each of firing states of neural cells (i.e., the up and down states). This means that as synaptic interactions may be responsible for generating up and down states in neural cells, ionic currents may have the same importance in this process because of their different characteristics in these two states. Indeed, a co-working between synapses and ionic mechanisms is responsible for generating up and down states. Different patterns of neural firings under different anesthetic drugs (Antkowiak et

al. 1997) can be an indication for this co-working because each anesthetic drug has its own unique influences on synaptic (Antkowiak 1999, 2001; Nishikawa and MacIver 2001) as well as on ionic channels (Bleakman et al. 1995; Ries and Puil 1999a, 1999b; Barash et al. 2005). This indicates that simulating specialized distinguished effects of different anesthetic drugs on EEG signals is only possible by the means of mean-field models if both synaptic and ionic currents are considered properly in these models.

In the context of sleep and anesthesia, different ionic mechanisms have been hypothesized for the slow switching of neural activities to the up and down states. Compte et al. (2003) assert that existence of slow Na^+ -dependent K^+ channels (IKNa) on pyramidal cells is mainly responsible for pulling down the state of neurons. Massimini and Amzica (2001) affirm that during the up state gradual reduction of extra cellular Ca^{2+} concentration in response to high activity of synapses, or opening a kind of specific Ca^{2+} channel can produce a global dysfacilitation in cortical network that lead it to down state. Bazhenov et al. (2002) suggest that progressive depression of excitatory interconnections and activation of Ca^{2+} -dependent K^+ currents eventually terminate neural firing. Compte et al. (2003) and Bazhenov et al. (2002) have the same opinion about transitions of neural populations from down to up state. They declare that random summations of miniature EPSPs in some neocortical pyramidal cells are responsible for the switching from down to up state. They assert summations of miniature EPSPs activate persistent Na^+ channels (INa(p)) which leads to generation of action potentials. Massimini and Amzica (2001) suggest when neurons become hyperpolarized, extra cellular Ca^{2+} concentration is increased linearly and dysfacilitation is removed from the network until neurons resume their firing in the up state.

The aforementioned ionic mechanisms are only some possibly responsible mechanisms for generating slow oscillation in the cortex. Although slow oscillation is cortical in origin (Timofeev and Steriade 1996; Timofeev et al. 2000; Kasanetz et al. 2002), other kinds of slow mechanisms may also interfere with the ionic mechanisms in the cortex to generate a variety of slow activities in the brain in the delta band. For instance, intrinsic properties of thalamocortical cells (e.g., I_h and I_t ionic currents) may generate stereotype oscillations (Steriade et al. 1993) in the brain. During this activity neural cells alternate between a high and a low firing rate. This activity is reflected on EEG if thalamic cells are synchronized by a slow synchronizing signal such as the slow oscillation which is originated from the cortex (Contreras and Steriade 1995, 1996; Steriade and Contreras 1995; Contreras et al. 1996; Destexhe et al. 1998).

It can be imagined very easily how difficult it would be to include all the above-mentioned cortical and subcortical ionic mechanisms into a mean-field model. Instead, in the enhanced model the overall characteristics of these mechanisms are formulated by a generic slow mechanism. The activity of this mechanism is expressed by a variable resembling a gating variable that describes dynamics of opening or closing an ionic channel in a single cell level. In the enhanced model, this variable is responsible to activate an inward current when the membrane potential of excitatory population is low (i.e., in the down state). However, this gating variable could

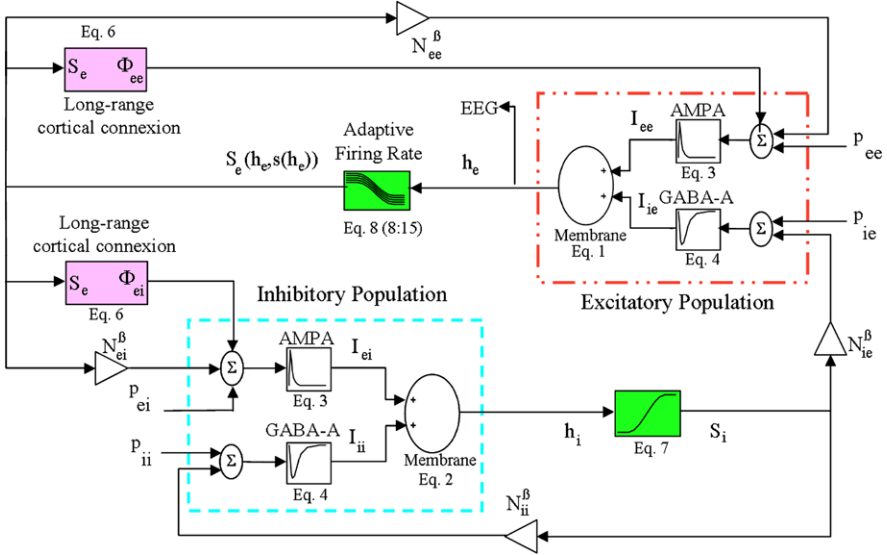

Fig. 9.7 Schematic diagram of the enhanced model

also inactivate an outward current in a low membrane potential, or activate (or inactivate) an outward (or inward) current in a high membrane potential (i.e., in the up state).

As a general comment, it should be mentioned that neuronal-level equations of gating variables describe properties of single ionic channels so they should not be inserted directly in mean-field models. An ionic current which is activated in a high potential by a burst of action potentials is not activated if it is included directly in a mean-field model without any modification in its formulations. A counterpart for this ionic current should be defined before inserting this ionic channel into mean-field models.

9.3.2 Structure of the Enhanced Model

In this part, the equations of the enhanced model along with their physiological interpretations are briefly described. Figure 9.7 illustrates a schematic diagram of the enhanced model.

Equations (9.1) and (9.2) depict the two principal differential equations of the model which express mean membrane potentials of excitatory and inhibitory populations.

$$\tau_e \frac{dh_e(t)}{dt} = -h_e + \psi_{ee}(h_e)I_{ee}(h_e) + \psi_{ie}(h_e)I_{ie}(h_i), \quad (9.1)$$

$$\tau_i \frac{dh_i(t)}{dt} = -h_i + \psi_{ei}(h_i)I_{ei}(h_e) + \psi_{ii}(h_i)I_{ii}(h_i), \quad (9.2)$$

where j and k represent either excitatory (e) or inhibitory (i). $\psi_{jk}(h_k) = (h_j^{\text{rev}} - h_k)/(h_j^{\text{rev}} - h_k^{\text{rest}})$ is a voltage-dependent scaling factor for a j -type PSP function (i.e., PSP impulse response) on k population. I_{jk} represents the voltaic influence of j -type PSPs on k population. I_{jk} is calculated by convolving the firing rate of k population by j -type PSP function. The following two equations express all the four combinations of these voltaic influences between j and k populations:

$$\begin{aligned} & \left(\frac{d}{dt} + \gamma_e \right) \left(\frac{d}{dt} + \tilde{\gamma}_e \right) I_{ek}(t) \\ &= [N_{ek}^\beta S_e(h_e, s) + \Phi_{ek} + p_{ek}] G_e \tilde{\gamma}_e e^{\gamma_e \delta_e (\gamma_e, \tilde{\gamma}_e)}, \quad k \in \{e, i\}, \end{aligned} \quad (9.3)$$

$$\begin{aligned} & \left(\frac{d}{dt} + \gamma_i \right) \left(\frac{d}{dt} + \tilde{\gamma}_i \right) I_{ik}(t) \\ &= [N_{ik}^\beta S_i(h_i) + \Phi_{ik} + p_{ik}] G_i \tilde{\gamma}_i e^{\gamma_i \delta_i (\gamma_i, \tilde{\gamma}_i)}, \quad k \in \{e, i\}. \end{aligned} \quad (9.4)$$

In these equations, excitatory and inhibitory PSP functions are in fact represented by two biexponential functions. G_j , γ_j and $\tilde{\gamma}_j$, where $j \in \{e, i\}$, determine maximum values and time rates of these biexponential functions. These parameters may vary with anesthetic concentrations. However, the influence of an anesthetic on the biexponential functions can be formulated easier if two alternative parameters δ_j and ζ_j are defined for γ_j and $\tilde{\gamma}_j$ parameters. δ_j is the time lag for maximum peak of PSP function, and ζ_j is the decay time of PSP function (Bojak and Liley 2005).

Bracketed terms in right sides of equations and represent excitatory-type and inhibitory-type firings, respectively. These brackets include two or three different sources of firings: excitatory subcortical inputs (p_{jk}), distant from other macrocolumns (Φ_{jk}), and, locally generated in the same macrocolumn ($N_{jk}^\beta S_j$). N_{jk}^β is the number of connections between j and k populations, and S_j is the firing rate of j population.

Each subcortical input noise is modeled as below:

$$p_{jk}(t) = \bar{p}_{jk} + \alpha \bar{p}_{jk} \xi_{jk}(t), \quad (9.5)$$

where \bar{p}_{jk} express the mean firing that k population receive from j -type subcortical firings. $\xi_{jk}(t)$ is a zero mean uniform white noise and it is extended between -1 and $+1$, and α is a scaling factor that controls the variance of the noise ($\alpha^2 \bar{p}_{jk}^2/3$) and prevents generation of negative-value subcortical firings.

Distant generated firings (Φ_{jk}) are only confined to excitatory-type firings (see (9.6) below). Φ_{ik} is set to zero because long-distance coupling from inhibitory populations is unlikely. In (9.6) \bar{v} is the mean axonal conduction speed, Λ_{ek} is the spatial drop off rate of long-range excitatory connections to population k , and N_{ek}^β is the total number of long-range synaptic connections.

$$\left(\frac{d}{dt} + \bar{v} \Lambda_{ek} \right) \Phi_{ek}(t) = \bar{v}^2 \Lambda_{ek}^2 N_{ek}^\alpha S_e(h_e, s). \quad (9.6)$$

In the above equations, S_e and S_i are the last two functions that have not been defined yet completely. These functions express firing rates of excitatory and inhibitory populations, respectively. The function S_i determines the firing rate of the

inhibitory population by a static function directly from actual value of mean membrane potential of inhibitory population. A well-known sigmoid function, the so-called Wilson and Cowan function, is employed to represent this relationship (Wilson and Cowan 1972).

$$S_i(h_i) = S_i^{\max}/[1 + \exp(-g_i(h_i - \theta_i))]. \quad (9.7)$$

In (9.7) above S_i^{\max} defines the maximum firing rate, and θ_i and g_i express inflection point of the sigmoid function and the slope of the function at this point, respectively. In the enhanced model, S_e is not only a function of actual value of mean membrane potential of excitatory population, i.e., the Wilson–Cowan function, but it is also a function of the activity of a generic slow ionic mechanism (s) as follows:

$$S_e(h_e, s) = [F_1(s)S_e^{WC}(h_e) + F_2(s)S_e^{\text{mod}}]/(F_1(s) + F_2(s)). \quad (9.8)$$

S_e^{WC} is the Wilson–Cowan sigmoid function which is defined to $S_e^{WC}(h_e) = S_e^{\max}/[1 + \exp(-g_e(h_e - \theta_e))]$, and $F_1(s)$ and $F_2(s)$ are two anti-symmetric sigmoid weighting functions as below:

$$F_1(s) = a(1 - B)/[1 + \exp(-g_F(s - \theta_F))] + b_1, \quad (9.9)$$

$$F_2(s) = aB/[1 + \exp(g_F(s - \theta_F))] + b_2. \quad (9.10)$$

Indeed, the equations above gather two different terms of firing rates: S_e^{WC} and a constant modulating firing rate S_e^{mod} . The normalized weighted combination of these two terms determines the overall firing rate of excitatory population. The activity of slow ionic mechanism (s) determines these weighting factors. Activation of the slow mechanism (i.e., an increase in the s value) increases the weighting function $F_2(s)$ and augments the role of S_e^{mod} in determining the value S_e . In the enhanced model, S_e^{mod} is set to a value greater than S_e^{\max} . This indicates that the activation of slow ionic mechanism will increase firing rate of excitatory population, and thus s serves as an activator mechanism in the enhanced model. In (9.9) and (9.10), B is a free parameter which controls the maximum amount of modulating effect of parameter S_e^{mod} on S_e , by changing the balance between $F_1(s)$ and $F_2(s)$. θ_F and g_F determine inflection points of $F_1(s)$ and $F_2(s)$ sigmoid functions, and their corresponding slopes. g_F takes negative values so $F_1(s)$ and $F_2(s)$ are always descending and ascending functions, respectively. b_1 and b_2 are two constant values, and they are used to set the values of F_1 and F_2 to unity and zero, respectively, at $s = 0$. θ_F determines the convexity of F_1 and F_2 in the interval $[0, s_\infty^{\max}]$, and finally, the parameter a ensures that $F_1(s)$ and $F_2(s)$ take always the same values in their boundaries at $s = 0$ and s_∞^{\max} for a given value B regardless of the values θ_F and g_F . In brief, a , b_1 and b_2 can be expressed mathematically as below:

$$a = \frac{(1 + \exp(g_F(s_\infty^{\max} - \theta_F)))(1 + \exp(-g_F\theta_F))}{(1 + \exp(3.5(0.1 - s_\infty^{\max})))(1 + \exp(0.1 \times 3.5))} \times \frac{(1 - \exp(-3.5s_\infty^{\max})) \exp(3.5 \times 0.1)}{(1 - \exp(g_F s_\infty^{\max})) \exp(-g_F\theta_F)}, \quad (9.11)$$

$$b_1 = 1 - a(1 - B)/(1 + \exp(g_F\theta_F)), \quad (9.12)$$

$$b_2 = -aB/(1 + \exp(-g_F\theta_F)). \quad (9.13)$$

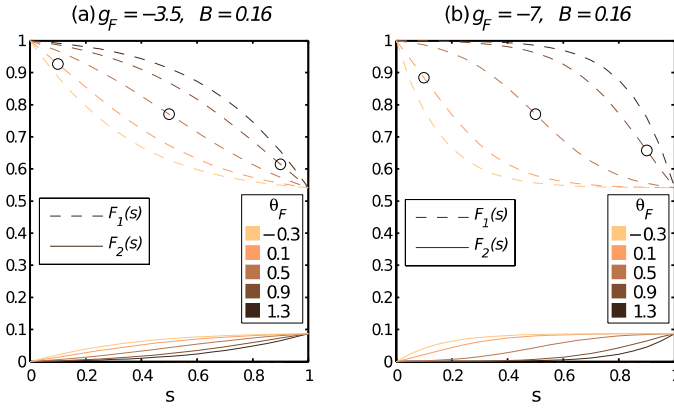

Fig. 9.8 Influences of θ_F and g_F on weighting functions $F_1(s)$ and $F_2(s)$. These two functions determine the firing rate of excitatory population based on two competing terms $S_e^{WC}(h_e)$ and s_e^{mod} . Increment of s raises the firing rate by increasing and decreasing the value of $F_2(s)$ and $F_1(s)$, respectively. θ_F determines convexities of these functions. If θ_F is smaller than zero, $F_1(s)$ and $F_2(s)$ are convex and concave functions, respectively, in $[0, s^{max}]$ interval. Convexities are reversed if θ_F is greater than s^{max} . In the two between, these functions are inflected at the points indicated by circles in the figure. g_F controls the slope of weighting functions

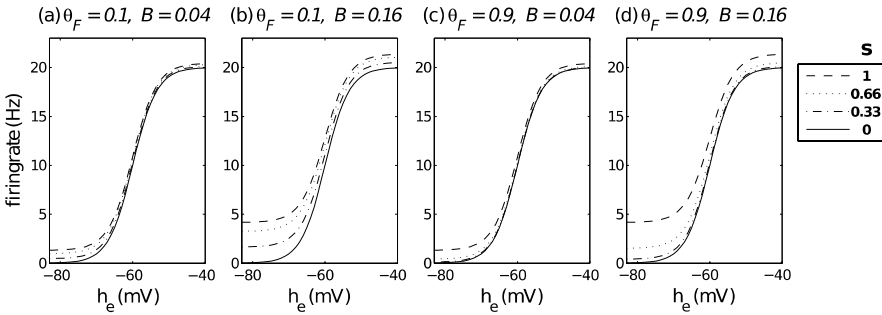

Fig. 9.9 Influences of s , θ_F and B on excitatory firing rate. Increase of s raises the firing rate especially in low membrane potentials. Increasing B from 0.04 to 0.16 increases the influence of s on the increase of excitatory firing rate (compare panels **a**, **c** with panels **b**, **d**). θ_F affects the ascending shape of firing rate function (compare panels **a**, **b** with panels **c**, **d**). However, it does not change boundary values of the firing rate (i.e., at 0 and $s_{\infty}^{max} = 1$)

In the equations above, the parameter set $\{\theta_F, g_F\} = \{0.1, -3.5\}$ has been chosen as a reference parameter set. For these parameters, it is $a = 1$. Figure 9.8 illustrates $F_1(s)$ and $F_2(s)$ for some different values of θ_F and g_F . For each pair of θ_F and g_F , b_1 , b_2 and a are determined by (9.11), (9.12) and (9.13), so that boundary values of $F_1(s)$ and $F_2(s)$ do not change for a given B value. In order to see the influences of the parameters s , θ_F and B on firing rate of excitatory population, we select some samples of these variables to $\{0, 0.33, 0.66, 1\}$, $\{0.1, 0.9\}$ and $\{0.16, 0.04\}$, respectively, and show their corresponding excitatory firing rates in Fig. 9.9. Increasing the

value of s raises the excitatory firing rate, especially when the membrane potential is low. This characteristic is ideal for mimicking generation of spikes or bursts in low membrane potentials when a slow ionic mechanism is activated. A comparison between left and right panels in Fig. 9.9 indicates that B magnifies the influence of s on the increase of firing rate. It is not worthy to say that B does not change the firing rate of excitatory population when the ionic mechanism is inactive ($s = 0$). By comparing the panels in top and bottom, it can be realized that θ_F changes the ascending patterns of sigmoid functions. However, it does not modify the boundary values of excitatory firing rates corresponding to $s = 0$ and s_∞^{\max} .

The latter equations expressed the firing rate of excitatory population as a function of membrane potential and slow ionic mechanism. Now the last thing that should be expressed is the activity of slow ionic mechanism (s). As mentioned before, in single cell models s could be expressed by a set of gating variables that describe activations or inactivations of desired slow ionic channels. However, in the enhanced mean-field model an alternative way was used for expressing s . In fact, it was assumed that the variable s slowly follows an instantly voltage-dependent parameter $s_\infty(h_e)$ based on a first order differential equation expressed in (9.14), (9.15) below. $s_\infty(h_e)$ is the activity of the slow mechanism when the membrane potential is kept constant. Since the slow mechanism is assumed to be activated in the down state, $s_\infty(h_e)$ has to take a high value when the excitatory membrane potential is low. This characteristic can be obtained by a descending sigmoid function as it is expressed in previous equations.

$$\tau_s \frac{d}{dt} s(t) = s_\infty - s(t), \quad (9.14)$$

$$s_\infty = S_s(h_e) = s_\infty^{\max} / (1 + \exp(-g_s(h_e - \theta_s))), \quad g_s < 0. \quad (9.15)$$

In the equations above, τ_s is the time constant of the slow mechanism, s_∞^{\max} is the maximum value of the descending sigmoid function, θ_s is the inflection point of the sigmoid function, and g_s is the slope at the inflection point.

9.4 Investigation of the Theoretical Characteristics of the Enhanced Model

The theoretical behavior of the model is investigated in order to identify equilibrium solutions and transition areas in the space of parameters. The theoretical spectrum is also determined in order to investigate the ability of the model to mimic EEG data.

9.4.1 Equilibrium Solutions and Eigenspectra

As there is no algebraic method for determining equilibrium solutions of the nine connected differential equations presented in the previous section, they should be

found numerically. In order to do so, all d/dt -terms and input noises are firstly set to zero, and then h_e is treated as an independent variable so that $S_i(h_i)$ can be estimated as a function of h_e as follows:

$$\hat{S}_i(h_e) = \frac{\gamma_i}{e^{\gamma_i \delta_i} G_i \psi_{ie}(h_e) N_{ie}^\beta} (h_e - h_e^{\text{rest}} - \psi_{ee}(h_e) I_{ee}(h_e)) - \frac{\bar{p}_{ie}}{N_{ie}^\beta}.$$

Using the inverse transform of the inhibitory firing rate function (i.e., the Wilson–Cowan function), \hat{h}_i is calculated from $\hat{S}_i(h_e)$ as below:

$$\hat{h}_i(\hat{S}_i(h_e)) = \theta_i - \frac{1}{g_i} \ln(S_i^{\text{max}} / \hat{S}_i(h_e) - 1).$$

Now, the parameter h_i can be substituted by its estimated value \hat{h}_i . Doing so provides the possibility of expressing the Wilson–Cowan term of excitatory firing rate as below:

$$\begin{aligned} & \hat{S}_e^{WC}(\hat{h}_i) \\ &= \frac{F_1(s_\infty) + F_2(s_\infty)}{F_1(s_\infty)(N_{ei}^\beta + N_{ei}^\alpha)} \left(\frac{\gamma_e}{e^{\gamma_e \delta_e} G_e \psi_{ee}(\hat{h}_i)} [\hat{h}_i - h_i^{\text{rest}} - \psi_{ii}(\hat{h}_i) I_{ii}(\hat{h}_i)] - \bar{p}_{ei} \right) \\ & \quad - \frac{F_2(s_\infty) S_e^{\text{max}}}{F_1(s_\infty)}. \end{aligned} \quad (9.16)$$

Then utilizing the inverse form of the Wilson–Cowan function, it is possible to express \hat{h}_e as follows:

$$\hat{h}_e(h_e) = \hat{h}_e(\hat{S}_e^{WC}(\hat{h}_i(h_e))) = \theta_e - \frac{1}{g_e} \ln(S_e^{\text{max}} / \hat{S}_e^{WC}(\hat{h}_i) - 1).$$

A given h_e that fulfills the condition $h_e - \hat{h}_e = 0$ will be an equilibrium solution for excitatory population membrane potential which is expressed by h_e^0 . Correspondingly, the equilibrium solution of inhibitory population membrane potential is expressed by h_i^0 . For small deviations from a stable equilibrium solution a non-linear system can be well approximated by the corresponding linear system derived by linearizing the system about that equilibrium state. It is straightforward to take Fourier transform of the linearized model to obtain the eigenspectrum. The eigenspectrum of the output signal (EEG) in the enhanced model is expressed as follows (proof in Molaee-Ardekani 2008):

$$\begin{aligned} P(\omega) &= \frac{P(f)}{2\pi} = \tilde{h}_e \tilde{h}_e^* \\ &= \frac{\alpha^2 (|DE|^2 \bar{p}_{ee}^2 + |DF|^2 \bar{p}_{ie}^2 + |BG|^2 \bar{p}_{ei}^2 + |BH|^2 \bar{p}_{ii}^2)}{6\pi |AD - BC|^2} \end{aligned} \quad (9.17)$$

where

$$A = i\omega\tau_e - c_1 - \frac{\psi_{ee}^0 c_3 \Gamma_e}{L_e(\omega) M(\omega)} - \frac{\psi_{ee}^0 N_{ee}^\beta \rho_e \Gamma_e}{L_e(\omega)}, \quad B = \frac{N_{ie}^\beta \rho_i \psi_{ie}^0 \Gamma_i}{L_i(\omega)},$$

$$\begin{aligned}
C &= \frac{N_{ei}^\beta \rho_e \psi_{ei}^0 \Gamma_e}{L_e(\omega)} - \frac{\psi_{ei}^0 c_4 \Gamma_e}{L_e(\omega) M(\omega)}, & D &= i\omega \tau_i - c_2 - \frac{\psi_{ii}^0 N_{ii}^\beta \rho_i \Gamma_i}{L_i(\omega)}, \\
E &= \frac{\psi_{ee}^0 \Gamma_e}{L_e(\omega)}, & F &= \frac{\psi_{ie}^0 \Gamma_i}{L_i(\omega)}, & G &= \frac{\psi_{ei}^0 \Gamma_e}{L_e(\omega)}, & H &= \frac{\psi_{ii}^0 \Gamma_i}{L_i(\omega)}, \\
L_{j \in \{e, i\}}(\omega) &= (i\omega + \gamma_j)(i\omega + \tilde{\gamma}_j), & M(\omega) &= (i\omega + \bar{v}\Lambda)^2, \\
c_1 &= -1 + \frac{d\psi_{ee}}{dh_e} I_{ee}^0 + \frac{d\psi_{ie}}{dh_e} I_{ie}^0, & c_2 &= -1 + \frac{d\psi_{ei}}{dh_i} I_{ei}^0 + \frac{d\psi_{ii}}{dh_i} I_{ii}^0, \\
c_3 &= \bar{v}^2 \Lambda^2 N_{ee}^\alpha \rho_e, & c_4 &= \bar{v}^2 \Lambda^2 N_{ei}^\alpha \rho_e, \\
\rho_e &= \left(\frac{\partial S_e}{\partial F_1} \frac{\partial F_1}{\partial s} + \frac{\partial S_e}{\partial F_2} \frac{\partial F_2}{\partial s} \right) \frac{dS_s/dh_e}{1 + i\omega \tau_s} + \frac{\partial S_e}{\partial S_e^{WC}} \frac{\partial S_e^{WC}}{\partial h_e}, & \rho_i &= \frac{dS_i}{dh_i}.
\end{aligned}$$

9.4.2 Isoclines of Slow Mechanism and Excitatory Population Membrane Potential

One of the possible ways to study the influence of slow ionic mechanism s on the model behavior in different anesthetic concentrations is to sketch $ds/dt = 0$ and $dh_e/dt = 0$ isoclines (for convenience they are nominated as s, h_e -isoclines) and the trajectory of $s(t)$ and $h_e(t)$ signals in a same plane. In a stable equilibrium condition, s is very close to its target value s_∞ , but when a transition occurs (e.g., a transition from up to down state) s and s_∞ may have quite different values due to the existence of different time constants in the model especially τ_s . In such a condition, the behavior of the model can be investigated by isoclines. To sketch s, h_e -isoclines, all variables except s and h_e are set to their equilibrium values. If we let ds/dt in (9.14) be equal to zero and then estimate \hat{h}_e as a function of independent s parameter, we get an isocline nominated as $ds/dt = 0$ isocline because ds/dt is equal to zero for any point on this isocline. For simplicity we call this isocline the s -isocline. Similarly, estimating \hat{s} as a function of independent parameter h_e while $dh_e/dt = 0$ (see (9.1)) leads to h_e -isocline. Note that in the latter case, corresponding to each given value h_e, h_i should be set to its equilibrium value (\hat{h}_i^0). It means that for each fixed value of h_e we have to numerically compute \hat{h}_i^0 and \hat{s} in parallel. An alternative method is to use the method, described in Sect. 9.4.1, for finding equilibrium solutions of the model. In this case, the parameter s is treated as an independent variable, and corresponding to each value of s which is selected on the interval $[0, s_{\max}]$, equilibrium values of h_e and h_i parameters are found. These equilibrium solutions are indicated by h_e^* and h_i^* symbols, respectively.

Figure 9.10 illustrates two typical h_e -isocline and s -isocline superimposed in a same plane. Intersection points of these isoclines represent equilibrium solutions of the model. Except these points, any other point on the isoclines plane have non-zero ds/dt or dh_e/dt values. A vector field can be assigned to this plane to show ds/dt and dh_e/dt values at each given point in the plane. Length and direction of any member vector in this vector field show how and to what extent s and h_e vary if the

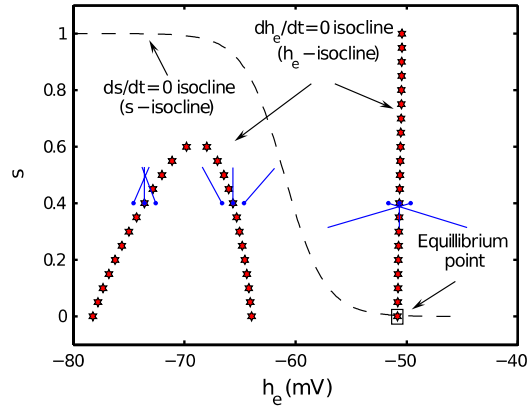

Fig. 9.10 A typical s -isocline (dashed line) and h_e -isocline (hexagrams) and nine candidate planar vectors. Origins of the vectors are located in $(s = 0.4, h_e^* + \Delta h_e)$ where $\Delta h_e = \{-1, 0, +1\}$ mV and h_e^* is the equilibrium point of the model for a given value of s (blue hexagrams). Coordinates of the intersection point of the two isoclines (s, h_e -isoclines) indicate equilibrium values of h_e and s parameters. Convergent or divergent directions of vectors around a given point on h_e -isocline determine stability or instability status of that point. [Taken with permission from Fig. 4 of Molaee-Ardekani et al. (2007)]

state of the model is located on the origin of that member vector. The nine indicated planar vectors in Fig. 9.10 are some examples of these member vectors. Since h_e is a faster variable than s , we are more interested in member vectors located in the vicinity of h_e -isocline. In fact, if a transition occurs in the model (e.g., from up to down state) h_e converges to its equilibrium value faster than s . This conveys the meaning that it is more likely that the trajectory of s and h_e signals is observed in the vicinity of h_e -isocline than in other points in the isoclines plane because h_e -isocline includes the points for which dh_e/dt is equal to zero.

9.5 Behavior of the Enhanced Model in Various Desflurane Concentrations

In this section, the behavior of the enhanced model is studied for different doses of a generic anesthetic agent from light to deep anesthesia. In each drug concentration, the simulated EEG signal is compared with a real EEG signal recorded in desflurane anesthesia. The protocol of real EEG recordings is the same as that described in Sect. 9.2.3. Interested readers may get more detailed information about this protocol in Tirel et al. (2006). In the enhanced model, amplitudes and time decays of IPSP and EPSP functions are the only parameters that are modified with anesthesia. These parameters are expressed by the following Hill equations as functions of drug concentration:

$$G_j(c_{MAC}) = G_j^0 \frac{K_j^{N_j} + M_j c_{MAC}^{N_j}}{K_j^{N_j} + c_{MAC}^{N_j}}, \quad j \in \{e, i\},$$

$$\zeta_i(c_{MAC}) = \xi_j^0 \frac{k_i^{n_i} + m_i c_{MAC}^{n_i}}{k_i^{n_i} + c_{MAC}^{n_i}}, \quad \zeta_e(c_{MAC}) = \zeta_e^0.$$

c_{MAC} is the alveolar drug concentration expressed in MAC (1 MAC is the minimum alveolar concentration of an anesthetic agent at 1 atmosphere pressure at which 50% of patients still move in response to a noxious stimulus). G_j^0 and ζ_j^0 are maximum amplitude and decay time of j -type PSP at zero drug concentration, respectively, and finally, $K_i, M_i, N_i, K_e, M_e, N_e, k_i, m_i$ and n_i are free parameters of the Hill equations, and they can be tuned specifically for each anesthetic drug. In the enhanced model these parameters were given for a generic anesthetic agent because no information was available relating the influence of desflurane agent on EPSP and IPSP functions.

Since MAC is an age dependent drug concentration measure, it is better to use a more solid units such as aqueous concentration (c_{Aq}) or vol% (c_{vol}) to express a drug concentration in above Hill equations. To do so, it is only necessary to multiply K_j and k_i parameters with a unit correction factor μ . For example, in desflurane anesthesia, 1 MAC is equivalent to administration of 8.3 vol% of this gas to young children (Mapleson 1996). This value corresponds to $c = 0.73$ mM aqueous concentrations of desflurane in saline (Franks and Lieb 1993, 1996) considering that saline/gas partition coefficient is 0.225 for desflurane (Eger 1987). In such a case, μ s equal to 0.73 and 8.3 for c_{Aq} and c_{vol} , respectively. Hereafter, the generic drug concentration (c) is given in aqueous format c_{Aq} .

9.5.1 Waking and Sedation

In the enhanced model, s, h_e -isoclines in waking state are very similar to those derived for very low drug concentrations. Figure 9.11a1–a4 illustrates some different aspects of the behavior of the enhanced model when drug concentration is set to a low value (here, $c = 0.2$ mM). Panel a1 illustrates a typical trajectory of $h_e(t)$ and $s(t)$ signals superimposed on s, h_e -isoclines, panel a2 shows time series of h_e in the time domain, panel a3 represent the histogram of h_e , and panel a4 shows the power spectrum of h_e and its corresponding eigenspectrum (solid line) which is calculated from (9.17). For comparison, a real EEG signal that is recorded in a child a few minutes before administration of desflurane is illustrated in Fig. 9.11a5.

Coordinates of the intersection point of the two isoclines determine equilibrium values of s and h_e . Head to head directions of the vectors about this point predict that it must be a stable equilibrium point. This was confirmed by performing the stability analysis of the model for this point (i.e., calculating eigenvalues of Jacobian matrix).

h_e -isocline shows that those equilibrium h_e^* values corresponding to $0.25 \leq s \leq 1$ make a single branch in the up state area, while those corresponding to $s \leq 0.25$

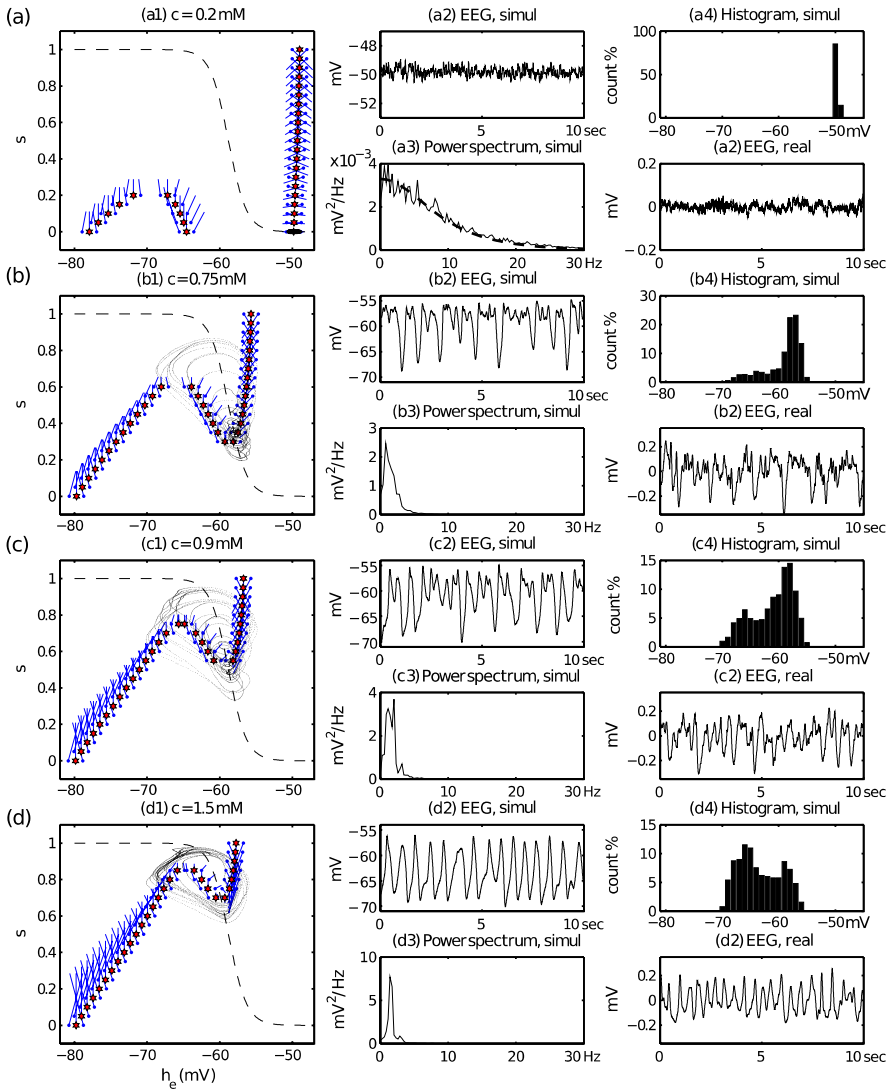

Fig. 9.11 Behavior of the enhanced model and comparison between simulated and real EEG signals recorded in children in different depths of desflurane anesthesia. **(a1)** superposition of s, h_e -isoclines (*dashed line and hexagrams*) and a 10 s trajectory of simulated (s, h_e) signals when the anesthetic concentration is set to 0.2 mM in the model. **(a2)** Time series of the $h_e(t)$ signal relating to the same trajectory shown in panel **(a1)**. **(a3)** Histogram of $h_e(t)$. The histogram was calculated from 1 min of simulated $h_e(t)$. **(a4)** Power spectrum of $h_e(t)$ and its corresponding eigenspectrum (*solid line*). **(a5)** A real EEG signal recorded in a child a few minutes before administration of anesthesia. The above descriptions for panel **(a1)** to **(a5)** are also applied for all sub-panels in sections **(b)** to **(d)** in the figure. The only difference is that section **(b)** refers to simulated signals at $c = 0.75$ mM, section **(c)** refers to $c = 0.9$ mM, and section **(d)** refers to $c = 1.5$ mM. Real EEG signals in panels **(b5)**, **(c5)** and **(d5)** are recorded in 1 MAC, transition from 1 to 2 MAC, and 2 MAC, respectively

make three branches in down, middle and up state areas. Equilibrium points locating in the middle branch are unstable, and the probability of finding a trajectory in the vicinity of these points is very low. On the other hand, it is highly probable that trajectories are found in the vicinity of h_e^* equilibrium points in the up state area. If h_e is initialized with a value greater than -64 mV, there is a high probability that $h_e(t)$ directly approaches to its equilibrium point in the up state area even without a transient trend to move toward the down state area. The very sharp peak in the histogram of $h_e(t)$ shows that the excitatory population is always located in the up state, without sudden transitions from the up to the down state.

9.5.2 Moderate Anesthetic Drug Concentration at About 1 MAC

When anesthetic concentration increases to a higher value (e.g. $c = 0.75$ mM) the right branch of h_e -isocline moves a little bit toward negative potentials, and the middle and the left branches (\cap -shape branches) move toward up and right (Fig. 9.11b1). Since s has a positive modulation effect on the firing rate of excitatory population, the movement of the \cap -shape branches toward higher values of s , is an indication that anesthesia shifts the balance between pyramidal and interneuron populations toward inhibition. For instance, when s is equal to 0.4, three equilibrium points now exist on h_e -isocline, whereas, for the same value of s , only one equilibrium point could be found on h_e -isocline when drug concentration was equal 0.2 mM.

The reduction of the distance between right and middle branches of h_e -isocline, spreads the distribution of h_e -fluctuations over a wider region along the up state area, and as a result, the probability of finding the trajectory in the vicinity of the middle branch increases. This can lead the trajectory to move along the barrier of the unstable branch or even to cross it to reach the down state area. This is the beginning phase of the appearance of slow-wave episodes on EEG signal. At first, most of trajectory cycles encounter the attraction of the top branch and the repulsion of the middle branch so they move back to the up state area. Those who reach the down state area appear semi-periodic high-amplitude negative pulses on $h_e(t)$ (Fig. 9.11b2). Such negative pulses extend the histogram of $h_e(t)$ toward negative potentials (Fig. 9.11b3), and it is the beginning phase of generating bimodal histograms. Negative pulses of $h_e(t)$ increase the overall power of the signal especially in the slow delta band (0–2 Hz) as is shown in Fig. 9.11b4.

If anesthetic concentration increases a bit more, trajectories jump easier over the barrier of the unstable area so the up-to-down state transitions become more regular. Figure 9.11c1 shows a typical trajectory of $h_e(t)$ and $s(t)$ signals when $c = 0.9$ mM. In a transition from the up to the down state, s_∞ increases rapidly and s follows it gradually. Increase of s continues until the trajectory approaches a returning point where sufficient modulating factors have been accumulated in the excitatory population. As a consequence, the trajectory switches back to the up state area. When the switching takes place, s gradually decreases until another up-to-down state transition occurs.

9.5.3 High Anesthetic Drug Concentration at About 2 MAC

For high concentrations of anesthetic drugs, the intersection point of the two isoclines is basically on the middle branch of h_e -isocline or very close to it. In such a case, the equilibrium point of the model may become an unstable point. The equilibrium solution of the model in $c = 1.5$ mM is one of the examples for which the equilibrium solution becomes unstable (see Fig. 9.11d). In such a condition, switching the trajectories to the up and down states is regular. This can be testified by means of the histogram of h_e fluctuations which depicts two dominant peaks: one in the up state and one in the down state area.

Surprisingly, although the equilibrium solution of the model in $c = 1.5$ mM is unstable, one can see that the top and the bottom branch of h_e -isocline are stable (note: on these branches s is treated as an independent parameter). Since s is not a very fast variable in the model, in short periods of time, it can be assumed that h_e fluctuations are, more or less, stable fluctuations during the up and down states. This characteristic is somehow consistent with what Wilson et al. (2009) have speculated regarding the existence of phase transitions and bi-stabilities within cortical neurons.

9.5.4 Burst Suppression

In very deep anesthesia, burst suppression may be generated when neural cells jump transiently from the down state to the up state. The enhanced model can reproduce such an activity if s, h_e -isoclines intersect in the down state area in the vicinity of the unstable middle branch of h_e -isocline (Fig. 9.12). In such a case, the trajectory of h_e and $s(t)$ signals is basically located in the down state area. However, it may transiently switch to the up state and then it comes back to its settling point in the down state area. The histogram of h_e fluctuations only includes one narrow peak in the down state area. If we assume that the variance of the input subcortical

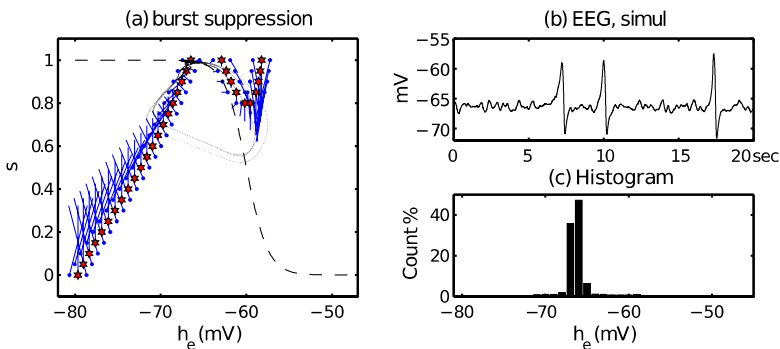

Fig. 9.12 Burst suppression in the enhanced model. (a) s, h_e isoclines and a 20-second (s, h_e) trajectory in high anesthetic drug concentration. (b) Time series of $h_e(t)$. (c) Histogram of the burst-suppression activity. The histogram only has one peak in down state area

noise reduces when anesthesia deepens, the histogram of h_e fluctuations becomes narrower and the amplitude of background EEG becomes smaller than what has been shown in Fig. 9.12b.

9.6 Discussions, Limitations and Challenges

9.6.1 *Different Working Modes in the Enhanced Model*

The enhanced model can have different working modes driven by anesthetic drug concentration. The model settles in the up state in waking period, it may work in the up state with some transient switches from the up state to the down state in moderate anesthesia, it switches in a regular manner to the up and to the down states in deep anesthesia, and finally, it remains in the down state with some transient switches to the up state in very deep anesthesia. In all above-mentioned working modes, the model always has only a single equilibrium solution which varies smoothly in a dose-dependent manner.

Since the concept of the up and down states has been considered in the enhanced model, it is guaranteed that maximum firing rates of excitatory and inhibitory populations do not change noticeably with anesthesia. In addition, smooth variation of the equilibrium solution of the model as shown in Molaei-Ardekani et al. (2007) implies that mean firing rates of neural population decrease smoothly with anesthesia. Indeed, what we know from literatures is that (i) maximum firing rates of neural cells do not change noticeably before and after infusion of an anesthetic (Antkowiak 1999), (ii) mean firing rates of neural cells mainly reduce by occurrences of silence phases between firing phases (Antkowiak and Heck 1997).

In the enhanced model, the sudden transition between awareness and unconsciousness may be interpreted by sudden transitions between the internal modes of neural populations that are induced by similar behaviors in single neurons as Fujisawa et al. (2006) explain. Our hypothesis is that awareness and unconsciousness are two disjoint mental states probably because firing patterns that correspond to these states (modes) are different from each other. In fact, these firing patterns can change rapidly from one mode to another mode (e.g. from a continuous mode to a phasic mode shown in Fig. 9.4) as if they change information processing modes of the brain suddenly from one mode to another. Nevertheless, the enhanced model cannot describe why LOC and ROC occur for different doses of anesthesia. Maybe in reality, changing the working modes of the brain is a process with some memories (as it is in the Steyn-Ross et al. model).

9.6.2 *Spindles and Alpha Activity*

A limitation for the enhanced model is that it only includes a single homogeneous neocortical module without considering other parts of the brain such as thalamus

and hippocampus. As a result, the enhanced model cannot be used to study traveling waves in the cortex. It also does not generate the 12 Hz activity in the alpha band that is usually observed in very light anesthesia. In fact, there are still some unsolved technical problems corresponding to the generation of alpha waves by mean-field models. Because of these problems that will be described here a little bit, the enhanced model was not forced to generate alpha activities in light anesthesia.

Basically, technical problems for generating alpha waves by the means of mean-field models arise from two different domains. Firstly, lack of a precise hypothesized mechanism that is responsible for generating alpha waves and spindles. Secondly, technical difficulties for the implementation the hypothesized mechanisms, which are mostly related to ionic mechanisms, in mean-field models.

Knowledge about the mechanism of alpha waves and spindles is very limited. To our knowledge, similarities and differences between underlying mechanisms of alpha waves and spindles have not been described yet clearly. In addition, we do not know exactly where and how these waves are generated in the brain. It has been suggested that spindles are generated in the thalamus (Steriade et al. 1987) and corticothalamic inputs control the patterns of activities in thalamus and thalamocortical networks (Destexhe et al. 1999; Blumenfeld and McCormick 2000). However, recent studies showed that a distributed network which consists of thalamus, cortex and hippocampus is engaged in alpha oscillations. It seems that a communication exists between neocortex and hippocampus during alpha oscillations (Sirota et al. 2003) and hippocampus can react to sensory stimuli with a 10 Hz enhancement (Schurmann et al. 2000).

Even if for simplicity we assume that spindles and alpha waves have, more or less, the same underlying mechanisms and that they are generated in a thalamocortical network (Steriade et al. 1987; Destexhe et al. 1999; Blumenfeld and McCormick 2000), we are still facing some technical problems for the realization of these modules and their corresponding ionic mechanisms in mean-field models. For instance, to correctly express the functionality of thalamic reticular cells in a mean-field model we need to redefine I_h and I_T channels in the mesoscopic level. In addition, bursting behavior of neural cells is another issue that should be also re-defined in mesoscopic level. Fortunately, few works related to this issue have been conducted (Suffczynski et al. 2004; Robinson et al. 2008), and they can be good starting points for future studies.

One of the complex issues to face out for producing alpha waves or spindles in mean-field models is that thalamocortical cells do not oscillate at 12 Hz. Instead, a superposition of 2–4 Hz activities generated by different sub-populations of thalamocortical cells is responsible for generation of 7–14 Hz oscillations (Bal et al. 1995; McCormick and Bal 1997). This means that a well-designed physiologically-based mean-field model for this purpose can probably be a model that includes a thalamus module with a few interconnected thalamocritical sub-populations inside.

The complexity of reproducing alpha waves in mean-field models becomes more complicated if we also consider the relation of alpha waves (or spindles) with delta-band activities that are generated in the cortex. For example, it has been shown that prolonged hyperpolarizations, induced by cortically generated slow waves, are

necessary so that spindles appear on EEG clearly (Steriade 2006). In fact, activities in delta and alpha bands are not disjoint activities in the brain. Slow oscillations in the brain can group and modulate the alpha band oscillations (Benoit et al. 2000; Fell et al. 2002; Steriade 2006). Recently, we have shown that the amplitude modulation of alpha band is a function of slow and fast delta activities (Molaei-Ardekani et al. 2010b). We have also shown that the characteristics of this modulation can vary with anesthesia.

9.6.3 Differences in Amplitudes

Another challenging problem that one may encounter in simulating an EEG signal by a mean-field model, including the enhanced model, is the difference between amplitudes of the signals that are generated in a stable mode and amplitudes of the signals that are generated in an unstable mode. For example, when the enhanced model is in a stable mode, the amplitude of the output EEG signal is basically low and it is mainly determined by the variances of input noises and the manner that trajectories fluctuate around the equilibrium solution of the model. These fluctuations can be characterized by transfer functions between input noises and the output EEG signal in the working point (i.e. equilibrium solution) of the model. On the other hand, in an unstable mode (e.g., limit-cycle), the amplitude of the output signal is basically high and it is not influenced a lot by variances of input noises. Indeed, when trajectories switch to the up and down states in an unstable condition, the amplitude of the output signal is mainly determined by the potential difference between the right and the left branches of h_e -isocline that are located in the up and in the down states, respectively.

In brief, it can be stated that the amplitude of a signal in a stable mode is determined by a mechanism that is different from the mechanism that controls the amplitude of a signal which is generated in an unstable condition. Due to this difference, sometimes the amplitude ratio of two reproduced signals in unstable and stable conditions may be a bit higher than the normal physiological range for this ratio. For instance, the increase in the amplitude ratio of K -complex and EEG background activities in the model of Wilson et al. (2006) is a bit higher than what is shown in Amzica and Steriade (2002). In the enhanced model, the amplitude ratio of reproduced EEG signals in unstable and stable conditions is in the order of 10, which is comparable with the amplitude ratio of EEG signals recorded in children by Constant group (Constant et al. 2005). However, this ratio is higher than what is obtained in adults (Schultz et al. 2004).

These differences in amplitude ratios may be explained as follows: If in the enhanced model, a trajectory approaches the up (down) state, it means that all constituting pyramidal neurons in the excitatory population are similarly approaching the up (down) state. But in reality, due to dissimilarities which exist even between similar neural cells locating in a same macrocolumn, they may switch to the up and down states not in a fully synchronized manner. As a consequence, since the synchronization is not perfect, the amplitude of the output signal may decrease a bit in

real EEG signals. This effect has not been considered in the enhanced model, and it can be a topic for future developments.

9.6.4 The Biphasic Response

What can be inferred from Sect. 9.2.3 is that the biphasic response that Kuizenga et al. introduce can be observed a few minutes after any rapid changes in the concentration of anesthetic drug. The biphasic responses which are observed at LOC and ROC are also two special cases of biphasic responses in which anesthetic drug is administered for the first time or removed permanently from the patient. These biphasic responses are indeed originated from transient responses of the brain at LOC and ROC. Since the enhanced model reproduces the EEG signals in a steady-state condition (i.e., the drug concentration is stabilized), it was not forced to generate the biphasic response which Kuizenga et al. introduce.

However, besides this kind of transient biphasic response, anesthetic agents can also induce another kind of stabilized biphasic response in EEG signal power. As shown by Fell group the EEG power in delta and theta bands is maximized at about 1/3 to 2/3 of concentration at the onset of burst suppression (C_{BS}) (Fell et al. 2005). It seems that the biphasic responses in the Steyn-Ross et al. model and in the Bojak-Liley model are more related to what is shown by Fell et al. than what is observed by Kuizenga et al. in transient modes of the brain. From this view point, the enhanced model can also generate a biphasic response because at 1 MAC it generates some aperiodic large-amplitude negative peaks that can increase the EEG power in delta and theta bands.

References

- Amzica F, Steriade M (2002) The functional significance of k-complexes. *Sleep Med Rev* 6(2):139–149
- Antkowiak B (1999) Different actions of general anesthetics on the firing patterns of neocortical neurons mediated by the GABAA receptor. *Anesthesiology* 91(2):500–511
- Antkowiak B (2001) How do general anaesthetics work? *Naturwissenschaften* 88(5):201–213
- Antkowiak B, Heck D (1997) Effects of the volatile anesthetic enflurane on spontaneous discharge rate and GABA(a)-mediated inhibition of Purkinje cells in rat cerebellar slices. *J Neurophysiol* 77(5):2525–2538
- Antkowiak B, Helfrich-Forster C (1998) Effects of small concentrations of volatile anesthetics on action potential firing of neocortical neurons in vitro. *Anesthesiology* 88(6):1592–1605
- Antkowiak B, Hentschke H, Kirschfeld K (1997) Effects of volatile anaesthetics on spontaneous action potential firing of cerebellar Purkinje cells in vitro do not follow the Meyer-Overton rule. *Br J Anaesth* 79(5):617–624
- Bal T, von Krosigk M, McCormick DA (1995) Synaptic and membrane mechanisms underlying synchronized oscillations in the ferret lateral geniculate nucleus in vitro. *J Physiol* 483:641–663
- Barash PG, Cullen BF, Stoetting RK (2005) Cellular and molecular mechanisms of anesthesia, 5th edn. Lippincott, Philadelphia, pp 111–131

- Bazhenov M, Timofeev I, Steriade M, Sejnowski TJ (2002) Model of thalamocortical slow-wave sleep oscillations and transitions to activated states. *J Neurosci* 22(19):8691–8704
- Benoit O, Daurat A, Prado J (2000) Slow (0.7–2 Hz) and fast (2–4 Hz) delta components are differently correlated to theta, alpha and beta frequency bands during nrem sleep. *Clin Neurophysiol* 111(12):2103–2106
- Bleakman D, Jones MV, Harrison NL (1995) The effects of four general anesthetics on intracellular $[Ca^{2+}]$ in cultured rat hippocampal neurons. *Neuropharmacology* 34(5):541–551
- Blumenfeld H, McCormick DA (2000) Corticothalamic inputs control the pattern of activity generated in thalamocortical networks. *J Neurosci* 20(13):5153–5162
- Bojak I, Liley DT (2005) Modeling the effects of anesthesia on the electroencephalogram. *Phys Rev E* 71:041902
- Compte A, Sanchez-Vives MV, McCormick DA, Wang XJ (2003) Cellular and network mechanisms of slow oscillatory activity (<1 Hz) and wave propagations in a cortical network model. *J Neurophysiol* 89(5):2707–2725
- Constant I, Seeman R, Murat I (2005) Sevoflurane and epileptiform EEG changes. *Paediatr Anaesth* 15(4):266–274
- Contreras D, Steriade M (1995) Cellular basis of EEG slow rhythms: a study of dynamic corticothalamic relationships. *J Neurosci* 15:604–622
- Contreras D, Steriade M (1996) Spindle oscillation in cats: the role of corticothalamic feedback in a thalamically generated rhythm. *J Physiol* 490:159–179
- Contreras D, Destexhe A, Sejnowski TJ, Steriade M (1996) Control of spatiotemporal coherence of a thalamic oscillation by corticothalamic feedback. *Science* 274(5288):771–774
- Deco G, Jirsa VK, Robinson PA, Breakspear M, Friston K (2008) The dynamic brain: from spiking neurons to neural masses and cortical fields. *PLoS Comput Biol* 4(8):e1000092
- Destexhe A, Contreras D, Steriade M (1998) Mechanisms underlying the synchronizing action of corticothalamic feedback through inhibition of thalamic relay cells. *J Neurophysiol* 79(2):999–1016
- Destexhe A, Contreras D, Steriade M (1999) Cortically-induced coherence of a thalamic-generated oscillation. *Neuroscience* 92(2):427–443
- Destexhe A, Rudolph M, Fellous JM, Sejnowski TJ (2001) Fluctuating synaptic conductances recreate in vivo-like activity in neocortical neurons. *Neuroscience* 107(1):13–24
- Eger NEI (1987) Partition coefficients of i-653 in human blood, saline, and olive oil. *Anesth Analg* 66(10):971–973
- Fell J, Elfadil H, Roschke J, Burr W, Klaver P, Elger CE, Fernandez G (2002) Human scalp recorded sigma activity is modulated by slow EEG oscillations during deep sleep. *Int J Neurosci* 112(7):893–900
- Fell J, Widman G, Rehberg B, Elger CE, Fernandez G (2005) Human mediotemporal EEG characteristics during propofol anesthesia. *Biol Cybern* 92(2):92–100
- Franks NP, Lieb WR (1993) Selective actions of volatile general anaesthetics at molecular and cellular levels. *Br J Anaesth* 71(1):65–76
- Franks NP, Lieb WR (1996) Temperature dependence of the potency of volatile general anesthetics: implications for in vitro experiments. *Anesthesiology* 84(3):716–720
- Fujisawa S, Matsuki N, Ikegaya Y (2006) Single neurons can induce phase transitions of cortical recurrent networks with multiple internal states. *Cereb Cortex* 16(5):639–654
- Hutt A, Longtin A (2009) Effects of the anesthetic agent propofol on neural populations. *Cogn Neurodyn* 4(1):37–59
- Jansen B, Rit V (1995) Electroencephalogram and visual evoked potential generation in a mathematical model of coupled cortical columns. *Biol Cybern* 73(4):357–366
- Jansen B, Zouridakis G, Brandt M (1993) A neurophysiologically-based mathematical model of flash visual evoked potentials. *Biol Cybern* 68(3):275–283
- Kasanetz F, Riquelme LA, Murer MG (2002) Disruption of the two-state membrane potential of striatal neurones during cortical desynchronisation in anaesthetised rats. *J Physiol* 543:577–589

- Kuizenga K, Kalkman CJ, Hennis PJ (1998) Quantitative electroencephalographic analysis of the biphasic concentration-effect relationship of propofol in surgical patients during extradural analgesia. *Br J Anaesth* 80(6):725–732
- Kuizenga K, Proost JH, Wierda JM, Kalkman CJ (2001a) Predictability of processed electroencephalography effects on the basis of pharmacokinetic-pharmacodynamic modeling during repeated propofol infusions in patients with extradural analgesia. *Anesthesiology* 95(3):607–615
- Kuizenga K, Wierda JM, Kalkman CJ (2001b) Biphasic EEG changes in relation to loss of consciousness during induction with thiopental, propofol, etomidate, midazolam or sevoflurane. *Br J Anaesth* 86(3):354–360
- Liley DT, Bojak I (2005) Understanding the transition to seizure by modeling the epileptiform activity of general anesthetic agents. *J Clin Neurophysiol* 22(5):300–313
- Liley DT, Cadusch PJ, Dafilis MP (2002) A spatially continuous mean field theory of electrocortical activity. *Network* 13(1):67–113
- Mahon S, Deniau JM, Charpier S (2001) Relationship between EEG potentials and intracellular activity of striatal and cortico-striatal neurons: an in vivo study under different anesthetics. *Cereb Cortex* 11(4):360–373
- Mapleson WW (1996) Effect of age on MAC in humans: a meta-analysis. *Br J Anaesth* 76(2):179–185
- Massimini M, Amzica F (2001) Extracellular calcium fluctuations and intracellular potentials in the cortex during the slow sleep oscillation. *J Neurophysiol* 85(3):1346–1350
- McCormick DA, Bal T (1997) Sleep and arousal: thalamocortical mechanisms. *Annu Rev Neurosci* 20:185–215
- Molaee-Ardekani B (2008) Modelling electrical activities of the brain and analysis of the EEG in general anesthesia. Joint PhD thesis, University of Rennes 1 and Sharif University of technology, Rennes-France and Tehran-Iran
- Molaee-Ardekani B, Shamsollahi MB, Senhadji L, Wodey E, Vosoughi-Vahdat B (2006) An investigation on different EEG patterns from awake to deep anesthesia: application to improve methods of determining depth of anesthesia. IFMBE proceedings, vol 14/1. Springer, Berlin, pp 909–912
- Molaee-Ardekani B, Senhadji L, Shamsollahi MB, Vosoughi-Vahdat B, Wodey E (2007) Brain activity modeling in general anesthesia: enhancing local mean-field models using a slow adaptive firing rate. *Phys Rev E* 76:041911
- Molaee-Ardekani B, Benquet P, Bartolomei F, Wendling F (2010a) Computational modeling of high-frequency oscillations at the onset of neocortical partial seizures: from ‘altered structure’ to ‘dysfunction’. *Neuroimage* 52(3):1109–1122
- Molaee-Ardekani B, Shamsollahi MB, Tirel O, Vosoughi Vahdat B, Wodey E, Senhadji L (2010b) Investigation of the modulation between EEG alpha waves and slow/fast delta waves in children in different depths of desflurane anesthesia. *IRBM* 31(1):55–66
- Nishikawa K, MacIver MB (2001) Agent-selective effects of volatile anesthetics on GABA_A receptor-mediated synaptic inhibition in hippocampal interneurons. *Anesthesiology* 94(2):340–347
- Pare D, Shink E, Gaudreau H, Destexhe A, Lang EJ (1998) Impact of spontaneous synaptic activity on the resting properties of cat neocortical pyramidal neurons in vivo. *J Neurophysiol* 79(3):1450–1460
- Rennie CJ, Wright JJ, Robinson PA (2000) Mechanisms of cortical electrical activity and emergence of gamma rhythm. *J Theor Biol* 205(1):17–35
- Ries CR, Puil E (1999a) Ionic mechanism of isoflurane’s actions on thalamocortical neurons. *J Neurophysiol* 81(4):1802–1809
- Ries CR, Puil E (1999b) Mechanism of anesthesia revealed by shunting actions of isoflurane on thalamocortical neurons. *J Neurophysiol* 81(4):1795–1801
- Robinson PA, Rennie CJ, Rowe DL (2002) Dynamics of large-scale brain activity in normal arousal states and epileptic seizures. *Phys Rev E* 65:041924
- Robinson PA, Rennie CJ, Rowe DL, O’Connor SC, Wright JJ, Gordon E, Whitehouse RW (2003) Neurophysical modeling of brain dynamics. *Neuropsychopharmacology* 28(Suppl 1):S74–S79

- Robinson PA, Wu H, Kim JW (2008) Neural rate equations for bursting dynamics derived from conductance-based equations. *J Theor Biol* 250(4):663–672
- Rudolph M, Pelletier JG, Pare D, Destexhe A (2005) Characterization of synaptic conductances and integrative properties during electrically induced EEG-activated states in neocortical neurons in vivo. *J Neurophysiol* 94(4):2805–2821
- Schultz A, Grouven U, Zander I, Beger FA, Siedenberg M, Schultz B (2004) Age-related effects in the EEG during propofol anaesthesia. *Acta Anaesthesiol Scand* 48(1):27–34
- Schurmann M, Demiralp T, Basar E, Basar Eroglu C (2000) Electroencephalogram alpha (8–15 Hz) responses to visual stimuli in cat cortex, thalamus, and hippocampus: a distributed alpha network? *Neurosci Lett* 292(3):175–178
- Schwender D, Daunderer M, Klasing S, Finsterer U, Peter K (1998) Power spectral analysis of the electroencephalogram during increasing end-expiratory concentrations of isoflurane, desflurane and sevoflurane. *Anaesthesia* 53(4):335–342
- Sirota A, Csicsvari J, Buhl D, Buzsaki G (2003) Communication between neocortex and hippocampus during sleep in rodents. *Proc Natl Acad Sci USA* 100(4):2065–2069
- Steriade M (2006) Grouping of brain rhythms in corticothalamic systems. *Neuroscience* 137(4):1087–1106
- Steriade M, Contreras D (1995) Relations between cortical and thalamic cellular events during transition from sleep patterns to paroxysmal activity. *J Neurosci* 15:623–642
- Steriade M, Domich L, Oakson G, Deschenes M (1987) The deafferented reticular thalamic nucleus generates spindle rhythmicity. *J Neurophysiol* 57(1):260–273
- Steriade M, Nunez A, Amzica F (1993) Intracellular analysis of relations between the slow (<1 Hz) neocortical oscillation and other sleep rhythms of the electroencephalogram. *J Neurosci* 13(8):3266–3283
- Steriade M, Timofeev I, Grenier F (2001) Natural waking and sleep states: a view from inside neocortical neurons. *J Neurophysiol* 85(5):1969–1985
- Steyn-Ross DA (2002) Modelling the anaestheto-dynamic phase transition of the cerebral cortex. PhD thesis
- Steyn-Ross DA, Steyn-Ross ML, Wilcocks LC, Sleight JW (2001a) Toward a theory of the general-anesthetic-induced phase transition of the cerebral cortex. II. numerical simulations, spectral entropy, and correlation times. *Phys Rev E* 64:011918
- Steyn-Ross ML, Steyn-Ross DA, Sleight JW, Wilcocks LC (2001b) Toward a theory of the general-anesthetic-induced phase transition of the cerebral cortex. I. a thermodynamics analogy. *Phys Rev E* 64:011917
- Steyn-Ross ML, Steyn-Ross DA, Sleight JW (2004) Modelling general anaesthesia as a first-order phase transition in the cortex. *Prog Biophys Mol Biol* 85(2–3):369–385
- Suffczynski P, Kalitzin S, Lopes Da Silva FH (2004) Dynamics of non-convulsive epileptic phenomena modeled by a bistable neuronal network. *Neuroscience* 126(2):467–484
- Timofeev I, Steriade M (1996) Low-frequency rhythms in the thalamus of intact-cortex and decorticated cats. *J Neurophysiol* 76(6):4152–4168
- Timofeev I, Grenier F, Bazhenov M, Sejnowski T, Steriade M (2000) Origin of slow cortical oscillations in deafferented cortical slabs. *Cereb Cortex* 10(12):1185–1199
- Tirel O, Wodey E, Harris R, Bansard JY, Ecoffey C, Senhadji L (2006) The impact of age on bispectral index values and EEG bispectrum during anaesthesia with desflurane and halothane in children. *Br J Anaesth* 96(4):480–485
- Wendling F, Bartolomei F, Bellanger JJ, Chauvel P (2002) Epileptic fast activity can be explained by a model of impaired GABAergic dendritic inhibition. *Eur J Neurosci* 15(9):1499–1508
- Wendling F, Hernandez A, Bellanger JJ, Chauvel P, Bartolomei F (2005) Interictal to ictal transition in human temporal lobe epilepsy: insights from a computational model of intracerebral EEG. *J Clin Neurophysiol* 22(5):343–356
- Weyand TG, Boudreaux M, Guido W (2001) Burst and tonic response modes in thalamic neurons during sleep and wakefulness. *J Neurophysiol* 85(3):1107–1118
- Wilson HR, Cowan J (1973) A mathematical theory of the functional dynamics of cortical and thalamic nervous tissue. *Kybernetik* 13:55–80

- Wilson HR, Cowan JD (1972) Excitatory and inhibitory interactions in localized populations of model neurons. *Biophys J* 12(1):1–24
- Wilson MT, Steyn-Ross DA, Sleigh JW, Steyn-Ross ML, Wilcocks LC, Gillies IP (2006) The k-complex and slow oscillation in terms of a mean-field cortical model. *J Comput Neurosci* 21(3):243–257
- Wilson MT, Barry M, Reynolds JN, Crump WP, Steyn-Ross DA, Steyn-Ross ML, Sleigh JW (2009) An analysis of the transitions between down and up states of the cortical slow oscillation under urethane anaesthesia. *J Biol Phys*
- Wodey E, Tirel O, Bansard JY, Terrier A, Chanavaz C, Harris R, Ecoffey C, Senhadji L (2005) Impact of age on both bis values and EEG bispectrum during anaesthesia with sevoflurane in children. *Br J Anaesth* 94(6):810–820

Chapter 10

A Neural Population Model of the Bi-phasic EEG-Power Spectrum During General Anaesthesia

A. Hutt

10.1 Introduction

The neuronal mechanisms of general anaesthesia are still poorly understood, though the induction of analgesia, amnesia, immobility and loss of consciousness by anaesthetic agents is well-established in hospital practice. To shed some light onto these mysterious effects, the last decades have focused mainly onto the study of molecular effects of agents and their relation to anaesthetic end points. Then, a decade ago Steyn-Ross et al. were among the first who studied the anaesthetic effects by a mathematical model of a neural population.¹ This model assumed a single neural population, i.e. a single brain area, that might experience external stochastic stimuli, e.g. from other populations. Although this model could not reproduce the experimental data in all details, it gave a rather simple answer to the question of the origin of the loss of consciousness (LOC) during anaesthesia.

The success of this first model triggered the development of other mathematical models that consider different features of neural populations than the ones in the model of Steyn-Ross et al. and hence allow other answers to the question of LOC. The present work introduces a new rather simple model of neural population activity that shares properties with previous models and introduces others, see the following sections for more details. By virtue of its mathematical simplicity, it might serve as a basic model for general anaesthesia that may be extended easily by further neural functions while retaining its simple structure.

In hospital practice, typically a perioperative information management system is set up, e.g. to store medical records of patients and to manage different medical treat-

¹Cf. Chap. 8 of Steyn-Ross et al. in this book.

A. Hutt (✉)

Team CORTEX, INRIA Grand Est – Nancy, 615 rue du Jardin Botanique,
54602 Villers-les-Nancy, France

e-mail: axel.hutt@inria.fr

ments during the patients stay (see Longnecker et al. 2008, Chap. 28). The system stores the physiological records extracted from monitoring systems that measure certain medical variables. The origin of the word *monitor* is the Latin word *monere*, which means *to warn*. Indeed, one of the important roles of monitoring is to alert the anaesthetist of changes in the patients' conditions. In addition, the monitoring system allows one to use the information received to modify therapeutic interventions and hence to regulate and control the medical treatment of the patient. Such information may come from haemodynamic monitoring which measures e.g. arterial blood pressure, respiratory monitoring or intraoperative neurologic monitoring. The latter detects electric activity on the scalp, the so-called electroencephalogram (EEG), which reveals information on neural activity. The present work focuses on some anaesthetic-induced effects on the EEG.

The medical EEG may be classified into two subtypes, cf. Chap. 32 in Longnecker et al. (2008). Desynchronous EEG exhibits rather large frequencies with low amplitudes, which result from small groups of mutually active neurons. This EEG pattern is contrasted by synchronous EEG showing low frequencies with large amplitudes which are assumed to result from large populations of cortical neurons that are triggered by thalamic stimulation (Amzica and Steriade 1998). Desynchronous EEG occurs when the subject is awake or during Rapid Eye Movement (REM)-sleep, while synchronous EEG is observed during non-REM sleep, cerebral ischemia, sedation or anaesthesia. To detect the loss of consciousness in patients, the anaesthetist is interested in the change from desynchronous to synchronous EEG. To this end, typically the bispectral index BIS is computed indicating the depth of anaesthesia (Rampil 1998). The decision at which index value the subject is unconscious is based on experience but the index range is limited. Typical BIS-values of the points of loss of consciousness are between 40 and 60 while $\text{BIS} = 100$ and $\text{BIS} \ll 40$ mean fully awake and deep anaesthesia, respectively.

Increasing the administered dose of anaesthetic agent increases its blood plasma concentration and the EEG changes from desynchronous to synchronous and the corresponding power spectrum may exhibit a bi-phasic behavior: at low agent concentration the power in certain frequency bands increase and finally decreases again for larger agent concentrations. This bi-phasic behavior can be found in the δ -, θ -, α - and β -frequency bands and the BIS is based on the power relation between these frequency bands. Since the BIS indicates well the loss of consciousness, the bi-phasic power spectrum is supposed to play an important role for the understanding of neural activity during anaesthesia.

To better understand the neural origin of the bi-phasic behavior of EEG, theoretical models have been developed. Such models describe mathematically the activity of a single neural population, cf. Chaps. 7, 8 and 9 of in this book. In brief, the original model approach of Steyn-Ross et al. (2004) proposes the change of activity resting states as the deciding mechanism during the loss of consciousness and explains the bi-phasic behavior by this state change. The original models of Liley and Bojak (2005) and Molaei-Ardekani et al. (2007) describe mathematically the bi-phasic behavior without a state change, but do not explain the loss of consciousness.

The model presented in this chapter differs mathematically from the previous ones and explains the bi-phasic behavior without a state change, but takes into account the possible state change. To illustrate this result, the subsequent section introduces the neural activity model and explains its difference to previous models in some detail. Then the synaptic effect of the anaesthetic agent propofol and its implementation into the model is discussed in Sect. 10.2.2, followed by a brief analytical study of the number of resting states. Finally, the last paragraphs in this section outlines the derivation of the systems' power spectrum and discusses the bi-phasic behavior found in the model activity. The last section summarizes the achieved results.

10.2 A Neural Population Model

The present work considers an ensemble of neurons on a mesoscopic spatial scale in the range of cortical macrocolumns, i.e. on a spatial scale of some millimeters. It considers pyramidal cells and interneurons, and consequently involves excitatory and inhibitory synapses. Both types of synapses may occur on dendritic branches of both cell types. In the following, we consider excitatory synapses (abbreviated by e) at excitatory (E) and inhibitory cells (I) and take into account inhibitory synapses (i) at both cell types.

Moreover, by virtue of the large number of neurons in the ensemble the activity of synapses and neurons are treated as averages over the population in small spatial patches and short time windows, see e.g. (Hutt and Atay 2005; Gerstner and Kistler 2002). The mean post-synaptic potentials (PSP) at excitatory cells in a spatial patch at spatial location x and at time t is denoted $V_{E,s}(x, t)$ and originates from excitatory ($s = e$) or inhibitory ($s = i$) synapses which receive spiking activity from other pre-synaptic neurons. Similarly, the PSPs $V_{I,s}(x, t)$ are evoked at inhibitory cells by pre-synaptic activity at excitatory ($s = e$) or inhibitory ($s = i$) synapses.

The four PSPs are modeled by

$$\begin{aligned} V_{N,e}(x, t) - V_N^r &= \int_{-\infty}^t h_e(t-t') P_E(x, t') dt', \\ V_{N,i}(x, t) - V_N^r &= \int_{-\infty}^t h_i(t-t') P_I(x, t') dt' \end{aligned} \quad (10.1)$$

with $N = E$ for excitatory cells and $N = I$ for inhibitory cells, V_N^r is the resting potential of neurons of type N and P_E and P_I denote the pre-synaptic mean pulse activity originating from excitatory and inhibitory cells, respectively. Here we assume that axonal connections from excitatory cells terminate at excitatory synapses only, which holds true for over 80 percent of excitatory cells (Nunez 1995). Moreover $h_e(t)$ and $h_i(t)$ represent the mean synaptic response functions of excitatory and inhibitory synapses and read (Koch 1999)

$$h_e(t) = a_e \frac{\alpha_1 \alpha_2}{\alpha_2 - \alpha_1} (e^{-\alpha_1 t} - e^{-\alpha_2 t}), \quad (10.2)$$

$$h_i(t) = a_i f(p) \frac{\beta_1(p) \beta_2}{\beta_2 - \beta_1(p)} (e^{-\beta_1(p)t} - e^{-\beta_2 t}), \quad (10.3)$$

with the temporal rates of the excitatory and inhibitory synapses $\alpha_{1,2}$ and $\beta_{1,2}$, respectively. This formulation of the mean synaptic response involves the various time scales of the synaptic response to an incoming spike, such as the membrane time constant of the dendrite, the voltage-dependent conductance change of the membrane (see e.g. Koch 1999, p. 18) and the propagation delays along the dendritic tree (see e.g. Koch 1999, pp. 49). The parameter $p \geq 1$ in (10.3) denotes a weighting factor that reflects the propofol concentration and $f(p)$ quantifies the propofol action on the inhibitory synapses. This formulation considers the synaptic effects of propofol only. In addition, a_e and a_i denote the level of excitation and inhibition, respectively.

Equations (10.1) give the mean synaptic responses in the ensemble and thus represent averages over all microscopic details of the synapto-dendritic system in the ensemble. Hence, the model does not take into account microscopic properties of synapses explicitly but consider their effect in the population.

For convenience, we may re-scale the time by $t \mapsto \sqrt{\alpha_1 \alpha_2} t$ and (10.1) are re-written as (Hutt and Longtin 2009)

$$\hat{L}_e(V_{N,e}(x, t) - V_N^r) = a_e P_E(x, t), \quad (10.4)$$

$$\hat{L}_i(p)(V_{N,i}(x, t) - V_N^r) = a_i f(p) \omega_0^2(p) P_I(x, t), \quad (10.5)$$

with the temporal operator $\hat{L}_s = \partial^2 / \partial t^2 + \gamma_s \partial / \partial t + \omega_s^2$, $s = e, i$ and

$$\begin{aligned} \omega_e^2 &= 1, & \omega_i &= \omega_0^2(p) = \beta_1(p) \beta_2 / \alpha_1 \alpha_2, \\ \gamma_e &= \sqrt{\alpha_1 / \alpha_2} + \sqrt{\alpha_2 / \alpha_1}, & \gamma_i &= (\beta_1(p) + \beta_2) / \sqrt{\alpha_1 \alpha_2}. \end{aligned}$$

To model the pre-synaptic mean pulse activity $P_E(x, t)$, $P_I(x, t)$ at spatial location x subjected to the firing activity of other neurons at spatial location y , we assume spatially homogeneous synaptic interactions via axonal branches with

$$\begin{aligned} P_N(x, t) &= K_N * S_N[V - \Theta_N] \\ &= \int_{\Omega} K_N(x - y) S_N \left[V \left(y, t - \frac{|x - y|}{v} \right) - \Theta_N \right] dy. \end{aligned}$$

This ansatz considers a one-dimensional neural population embedded in the spatial domain Ω with periodic boundary conditions. Moreover v denotes the finite conduction speed of axonal connections. The functionals $S_E[\cdot]$, $S_I[\cdot]$ represent the somatic firing function of excitatory and inhibitory cells which have a sigmoidal shape (Freeman 1979). The firing rate functions S_E , S_I are chosen as $S_N(V) = S_m / (1 + \exp(-c_N(V - \Theta_N)))$ and depend on the difference of the PSPs $V_{E,e} - V_{E,i}$ and $V_{I,e} - V_{I,i}$, respectively, since the corresponding synaptically evoked post-synaptic currents sum up at the neuron somata, cf. Freeman (1992), Hutt and Longtin (2009). Moreover Θ_E , Θ_I denote the corresponding mean firing thresholds. Synapses respond to cells which are located at different spatial locations and the functions K_E , K_I account for the corresponding spatial nonlocal connectivity. They represent the probability density of connections from excitatory

and inhibitory cells to excitatory and inhibitory synapses, respectively. This definition requires the normalization to unity, i.e. $\int_{\Omega} K_{E,I}(x) dx = 1$. Then (10.4), (10.5) read (Hutt and Longtin 2009)

$$\begin{aligned}\hat{L}_e(V_e(x, t) - V_E^r) &= a_e K_E * S_E[V_e(x, t) - V_i(x, t) - \Theta_E], \\ \hat{L}_i(p)(V_i(x, t) - V_E^r) &= a_i f(p) \omega_0^2(p) K_I * S_I[V_e(x, t) - V_i(x, t) - \Theta_I]\end{aligned}\quad (10.6)$$

with the excitatory and inhibitory PSPs now defined as $V_e = V_{E,e}$ and $V_i = V_{E,i}$. Equations (10.6) are the final evolution equations of the neural activity, while the action of propofol is considered in $\hat{L}_i(p)$, $f(p)$ and $\omega_0^2(p)$.

10.2.1 Yet Another Model?

The neural field model (10.6) defines some basic elements of neural interactions in populations to describe the spectral properties in general anaesthesia. Other population models consider different neural interactions. Several of these models are based on the model of Liley et al. (1999), see also Chap. 7 in this book. This model considers a continuous spatial mean-field of neurons in one or two spatial dimensions, synapses and axonal connections and where the synapses and neurons may be excitatory and inhibitory. This mean-field represents the spatial average in a neural population description similar to the present work and thus averages the spiking activity of single neurons using a sigmoidal population firing rate. The firing activity is assumed to spread diffusively via a damped activity wave along the axonal trees and terminates at pre-synaptic terminals. The wave speed of this axonal wave is set to the mean axonal conduction speed and hence assumes a volume conduction mechanisms for the spread along axonal fibers. At the synaptic terminals the incoming pre-synaptic activity evokes the temporal synaptic response on the dendritic trees according to the dynamics of a single synapse, i.e. treating the membrane as an RC-circuit with a time-dependent conductance, see e.g. Koch (1999). Consequently the model neglects the spatial extension of dendritic trees due to this explicit model of single synapse responses.

The model considered in the present work is similar to the model of Liley et al. in several aspects but differs in some other important elements. In contrast to the Liley model the presented model considers a population of synapses on dendritic trees (Koch 1999) and the passive activity spread on dendrites (Agmon-Sir and Segev 1993). To cope with the various delay distributions caused by the spatial distribution of synapses on the dendritic branches, the present model considers an average synaptic population response which obeys an average synaptic response function. In addition the present work models the activity transmission along axonal trees by taking into account the spatial probability density of axonal connections. This contrasts to the Liley model, which assumes a volume conduction mechanism for the activity spread along the axonal branch. Interestingly, previous theoretical studies have shown that the mathematical treatment of connection probability densities extends the damped activity wave considered in the model of Liley et al. to nonlocal interactions, cf. Coombes et al. (2007), Hutt (2007).

Previous studies have explained the bi-phasic behavior in the EEG-power spectrum by different mechanisms. Steyn-Ross et al. (2004) support the idea that the bi-phasic spectrum and the LOC result from a first-order phase transition in the population. This phase transition reflects a sudden disappearance of the system's resting state accompanied by a jump to another resting state. The associated jump in state activity has been interpreted as the sudden loss of consciousness as observed in experiments, see the corresponding chapter in this book. In contrast, Bojak and Liley (2005) showed in an extensive numerical study of a slightly different model that such a phase transition is not necessary to reproduce bi-phasic power changes, but did not suggest a mechanism for the occurrence of LOC. Moreover, Molaei-Ardekani et al. (2007) introduced the idea of slow adaptive firing rates which explains the bi-phasic spectrum and LOC without a phase transition, see the corresponding chapter in this book. The present model aims to show that the bi-phasic power spectrum is not restricted to a specific mechanism but may occur in the presence of both a single state, multiple states without an additional adaptive firing.

Summarizing, the model presented here simplifies specific aspects of the dynamics in single neurons but takes into account its major features. These features are the non-linear gain of cells originating from the distribution of the neurons firing threshold, the synaptic response function covering the diverse properties of synapses and dendritic compartments, and the spatial and temporal aspects of axonal branches. By virtue of these simplifications, the model is mathematically less complex than the Liley model since it has less parameters. This aspect allows for an analytical treatment of the model and, consequently, the analytical derivation of conditions for physiological parameters. The work aims to show that these elements are sufficient to describe the macroscopic dynamics of the neural population. This idea is supported by the excellent work of Roxin et al. (2006), who showed that neural field models may capture the macroscopic activity of a population of spiking neurons.

10.2.2 Synaptic Anaesthetic Effect

Our work focuses on the action of the anaesthetic agent propofol, which is a widely-applied anesthetic drug (Marik 2004). It affects the cognitive abilities of subjects, such as the response to auditory stimuli (Kuizenga et al. 2001) or pain (Andrews et al. 1997) and acts mainly on GABA_A receptors, i.e. changes the response of inhibitory synapses. In detail, increasing the blood concentration of propofol yields an increase of the charge transfer in synaptic GABA_A-receptors and increases the decay time constant of their synaptic response function (Kitamura et al. 2002).

The current model approach describes mathematically the effect of varying properties of inhibitory synapses on the spatio-temporal dynamics of the neural ensembles, while the origin of such variations are the anaesthetic actions of propofol. Specifically, increasing the concentration of propofol prolongs the temporal decay phase of inhibitory GABA_A synapses and increases the charge transfer in these synapse. In addition, the height of the synaptic response function is maintained for different propofol concentrations (Kitamura et al. 2002) in a good approximation.

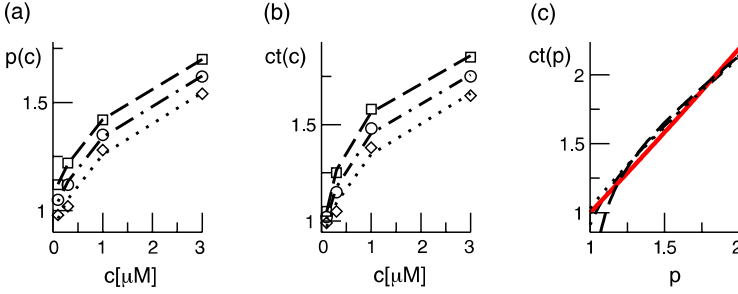

Fig. 10.1 Extraction of the charge transfer curve from experimental data (Fig. 6 in Kitamura et al. 2002) subjected to the factor p . The panel (a) shows the experimentally measured mean (circles) percentual increase of the inhibitory decay time p , their maximum (squares) and minimum (diamonds) values at the error interval borders and the corresponding fitted functions $p(c)$ (dashed line for maximum values, dashed-dotted line for the mean value and dotted line for the minimum values). (b) shows the experimentally measured mean (circles) percentual increase of the charge transfer, their maximum (squares) and minimum (diamonds) values at the error interval borders and the corresponding functions $ct(c)$, the line coding is the same as in (a). (c) presents the calculated relation $ct(p)$ for the mean values, the lower and upper value border and the model (red solid line), see text for model details. The line coding is the same as in (a)

To implement a similar behavior in our model, the factor p introduced in (10.3) reflects the target concentration of propofol in the neural population with $p = 1$ for vanishing propofol concentration. Since the function $f(p)$ introduced in (10.3) is set to affect the charge transfer in the inhibitory synapses, we choose the inhibitory charge transfer at vanishing propofol concentration such that $f(p = 1) = 1$, and identify the mean charge transfer with the level of the synaptic excitation or inhibition, cf. Hutt and Longtin (2009). Moreover, the model assumes that increasing p reflects an increasing propofol concentration which decreases the inhibitory decay rate by $\beta_1(p) = \beta_1^0/p$ with β_1^0 denoting the inhibitory decay rate in the absence of propofol. Consequently, $p = (1/\beta_1)/(1/\beta_1^0)$ represents the percentile increase of the inhibitory decay time constant. To mimic these assumption mathematically, we implement

$$f(p) = r^{-r/(r-1)}(rp)^{rp/(rp-1)}, \quad r = \beta_2/\beta_1 \quad (10.7)$$

which guarantees a constant height of the impulse response function $h_i(t)$ and reflects an increasing charge transfer of the inhibitory synapse $f(p)$ with increasing p . Typically the decay phase of the synaptic response curve is much longer than its rise phase, i.e. $\beta_1 \ll \beta_2$, $r \gg 1$ and thus $f(p) \approx p$.

To investigate the validity of the model assumptions, we consider experimental results on the synaptic response of GABA_A-synapses measured *in vitro* in cultured cortical neurons of rats (Kitamura et al. 2002). Figure 10.1(a) shows the mean values p obtained experimentally at GABA_A-synapses subject to the propofol concentration c , together with the extreme values of p at the borders of the error bars. The dependence of the percentile increase of the decay time constant p on the concentration c is set to $p(c) = k_1 * \ln(k_2 + k_3 * c)$ and the constants k_1 , k_2 , k_3 are mean-least

Fig. 10.2 The temporal impulse response function $h_i(t)$ of inhibitory synapses subject to various values of p taken from (10.3) and (10.7). Parameters are set to $\beta_1^0 = 75$ Hz, $\beta_2 = 1000$ Hz, which are typical for GABA_A-synapses (Koch 1999)

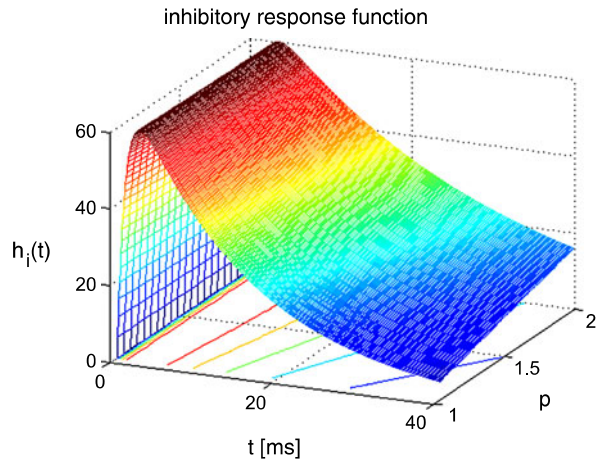

square fitted to the experimental data. In addition Fig. 10.1(b) gives the corresponding mean and extreme values of the normalized charge transfer $ct(c)$ obtained experimentally. This function is mean least-square fitted to $ct(c) = k_4 * \ln(k_5 + k_6 * c)$ with the constants k_4, k_5, k_6 . Then the normalized charge transfer subjected to the factor p can be computed to $ct(p) = f(p) = b_0 \ln(b_1 + b_2 e^{b_3 p})$ with $b_0 = k_4, b_1 = k_5 - k_2 k_6 / k_3, b_2 = k_6 / k_3, b_3 = 1 / k_1$. Figure 10.1(c) shows $ct(p)$, the corresponding functions obtained from the error borders and the model function (10.7) with $r = 8.5$ and we observe good accordance. Consequently the charge transfer model (10.7) is reasonable for $\beta_2 \approx 8.5\beta_1$.

Since the study of propofol effects in Kitamura et al. (2002) are based on experiments on rats, it is interesting to link the results to humans. In human general anaesthesia, the value EC_{50} gives the concentration of the anesthetic agent for which 50 of 100 subjects are anesthetized, i.e. do not respond to external stimuli or surgical incision. For the administration of propofol, a typical concentration is $0.2 \mu\text{M}/\text{ml}$ ($\sim 2 \mu\text{g}/\text{ml}$) (Franks and Lieb 1994), which corresponds to $p \approx 1.2$, cf. Fig. 10.1. For unit conversion of the propofol concentrations, the rule $1 \mu\text{g} \approx 0.1 \mu\text{M}$ holds (Franks and Lieb 1994).

Summarizing, increasing the factor p prolongs the decay phase and increases the charge transfer in inhibitory synapses while maintaining the amplitude of the resulting IPSPs constant. Figure 10.2 shows the simulated temporal impulse response of an inhibitory GABA_A synapse h_i as a function of time and of factor p . We observe a constant amplitude and a prolonged decay phase for increasing p , as desired.

10.2.3 Multiple Resting States

To gain insight into the resting activity of the neural population, let us first investigate the stationary solutions \bar{V}_e, \bar{V}_i of (10.6), which are assumed constant in space

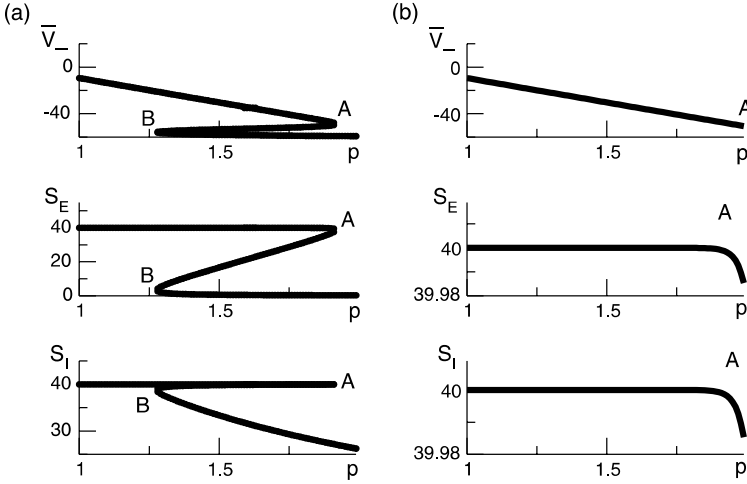

Fig. 10.3 The stationary solutions \bar{V}_- of (10.8), the firing rates of excitatory and inhibitory neurons $S_E = S_E(V - \Theta_E)$ and $S_I = S_I(V - \Theta_I)$, respectively, for both solution cases. (a) $\Theta_E > \Theta_I$, $c_e = c_i$, (b) $\Theta_E = \Theta_I$, $c_e = c_i$. The specific parameters are (a) $\Theta_E = -53$ mV, $\Theta_I = -60$ mV, $c_e = c_i = 0.84$ /mV, (b) $\Theta_E = \Theta_I = -60$ mV, $c_e = c_i = 0.24$ /mV. Additional parameters are $a_e = 1$ mV/s, (a) $a_i = 0.2$ mV/s, (b) $a_i = 1.4$ mV/s

and time. Introducing the new variables $\bar{V}_- = \bar{V}_e - \bar{V}_i$ and $\bar{V}_+ = \bar{V}_e + \bar{V}_i$, Equations (10.6) decouple to

$$\bar{V}_- = a_e S_E[\bar{V}_- - \Theta_E] - f(p) a_i S_I[\bar{V}_- - \Theta_I], \quad (10.8)$$

$$\bar{V}_+ = a_e S_E[\bar{V}_- - \Theta_E] + f(p) a_i S_I[\bar{V}_- - \Theta_I] + 2V_E^r. \quad (10.9)$$

Here \bar{V}_- is the stationary mean membrane potential that triggers spike generation in the neural population at the global resting state. Equations (10.8), (10.9) reveal that it is sufficient to determine \bar{V}_- from (10.8) to find \bar{V}_- and \bar{V}_+ and hence the number of solutions \bar{V}_- gives the number of stationary solutions.

A detailed study of the number of roots (Hutt and Longtin 2009) yields conditions for (a) three resting states for a limited range of values of p and a single resting state otherwise and (b) a single stationary state for all p . The three stationary solutions have been studied previously in some analytical details by Steyn-Ross et al. (2001) and the single stationary solution has been considered numerically by Bojak and Liley (2005), Molaei-Ardekani et al. (2007). These studies are based on the Liley model. In the following, we refer to the case of the single stationary solution as the single solution case and to the case of three stationary solutions as the triple solution case.

Figure 10.3 shows the solutions \bar{V}_- , and the resulting firing rates of excitatory and inhibitory neurons $S_E(\bar{V}_- - \Theta_E)$ and $S_I(\bar{V}_- - \Theta_I)$, resp., with respect to the weight factor p . In the triple solution case (Fig. 10.3(a)), the system starts at a high firing rate at $p = 1$ and shows an activity decrease up to point A. Then a further increase of p causes the stationary excitatory firing activity to discontinuously

jump to smaller values. In addition we observe a top, center and bottom solution branch. Likewise, the single stationary solution (Fig. 10.3(b)) exhibits a decrease of the firing rate while increasing p . However, here the drop of activity is continuous and the firing rate changes less abruptly than in the triple solution case. Such a continuous decrease of the firing rate while increasing the propofol concentration has been reported experimentally in cultures of rat neocortical tissue (Antkowiak 1999).

In mathematical terms, the triple solution case exhibits a saddle-node bifurcation and the first discontinuous drop of activity at point A. This bifurcation occurs if the left and right hand side of (10.8) exhibit the same derivative with respect to \bar{V}_- , i.e.

$$1 = a_e \delta_E(p) - a_i f(p) \delta_I(p). \quad (10.10)$$

Here $\delta_E(p) = \partial S_E[V(p) - \Theta_E] / \partial V$, $\delta_I(p) = \partial S[V(p) - \Theta_I] / \partial V$ evaluated at $V = \bar{V}_-$ represent the so-called non-linear gains of the system. Since $\delta_E(p)$, $\delta_I(p)$ are the slopes of the transfer functions S_E , S_I , they reflect the conversion of membrane potentials to the spike firing activity. In contrast to the triple solution case, the single stationary solution does not show this activity drop and exhibits $1 > a_e \delta_E(p) - a_i f(p) \delta_I(p)$ for all values of p , i.e. condition (10.10) never holds.

10.2.4 The Bi-phasic Power Spectrum

A prominent measure to determine the depth of general anaesthesia is the power spectrum of the subject's electroencephalogram (EEG). As outlined in Sect. 10.1, the prominent effect in power spectra during general anaesthesia is the bi-phasic change of frequency power while increasing the propofol concentration, i.e. the increase and then decrease of spectral power in the δ , θ , α and β band. To model this change of power spectrum with respect to factor p , the subsequent paragraphs derive the power spectrum of the EEG. The derivation of the power spectrum follows from previous studies on the effect of finite axonal conduction speed on the activity of neural populations involving a single neuron type (Hutt and Atay 2007; Hutt and Frank 2005).

10.2.4.1 The Power Spectrum

The power spectrum represents a statistical measure of system's linear response to a spatio-temporal external input. This input might originate from other neural populations and is assumed to be small compared to the resting states \bar{V}_e , \bar{V}_i defined by (10.8), (10.9). Moreover the power spectrum is defined in the linear regime and the system remains close to the resting state if it is linearly stable, see the work of Hutt and Longtin (2009) for a detailed study of the systems' stability. In the following, we assume that the system is stable, i.e. small perturbations do not repel the system too far from its stationary state determined in Sect. 10.2.3.

Considering the excitatory external input $\Gamma(x, t)$, the identities $\hat{L}_{e,i}h_{e,i}(t) = \delta(t)$ and linear terms only, (10.6) read

$$u_e(x, t) = a_e \delta_E \int_{-\infty}^t d\tau h_e(t - \tau) \int_{\Omega} dy K_e(x - y) \left(u_e \left(y, \tau - \frac{|x - y|}{v} \right) - u_i \left(y, \tau - \frac{|x - y|}{v} \right) \right) + \Gamma(x, t), \quad (10.11)$$

$$u_i(x, t) = a_i \delta_I f \omega_0^2 \int_{-\infty}^t d\tau h_i(t - \tau) \int_{\Omega} dy K_i(x - y) \left(u_e \left(y, \tau - \frac{|x - y|}{v} \right) - u_i \left(y, \tau - \frac{|x - y|}{v} \right) \right). \quad (10.12)$$

The variables $u_e(x, t) = V_e(x, t) - \bar{V}_e$ and $u_i(x, t) = V_i(x, t) - \bar{V}_i$ denote the deviations from the stationary states \bar{V}_e and \bar{V}_i and depend linearly on the evoked currents in the membrane that are present in the dendritic tree and its surrounding. These evoked currents propagate along the dendritic branch toward and away from the trigger zone at the neuron soma. Since excitatory and inhibitory currents add up at the trigger zone and have different signs, the corresponding potentials also sum up at the trigger zone. This means the effective membrane potential $u_e(x, t) - u_i(x, t)$ is proportional to the current that flows in the tissue close to the dendritic branch and along the dendritic branch. This physical effect is supposed to represent the origin of the EEG since the evoked current represents a current dipole that generates the electromagnetic activity on the scalp. Such currents are measured experimentally by electrodes in the neural tissue and the corresponding potentials are the LFPs. Consequently LFPs reflect the dendritic currents or correspondingly the membrane potentials on the dendrites. Since the EEG represents the spatial average of the dendritic activity in a good approximation, cf. Nunez and Srinivasan (2006), we consider the effective membrane potential $u(x, t) = u_e(x, t) - u_i(x, t)$, which is proportional to the dendritic currents.

The neural population activity is assumed to be in a stationary state in the presence of the external stationary input. Then the ergodicity assumption holds and the power spectrum of $u(x, t)$ at the spatial location x is given by the relation

$$P_{LFP}(x, \omega) = \frac{1}{\sqrt{2\pi}} \int_{-\infty}^{\infty} d\tau C_{LFP}(x, \tau) e^{i\omega\tau} \quad (10.13)$$

with the autocorrelation function $C_{LFP}(x, \tau) = \langle u(x, t)u(x, t - \tau) \rangle$ and the ensemble average $\langle \dots \rangle$, i.e. the average over many realizations.

The external input to the network $\Gamma(x, t)$ represents the excitatory synaptic responses to random fluctuations uncorrelated in space and time $\xi(x, t)$ with $\langle \xi(x, t) \rangle = 0$, $\langle \xi(x, t)\xi(y, T) \rangle = Q\delta(x - y)\delta(t - T)$ and the fluctuation strength Q and the input reads

$$\Gamma(x, t) = \int_{-\infty}^t d\tau h_e(t - \tau)\xi(x, \tau) \quad (10.14)$$

with the synaptic response function $h_e(t)$ taken from (10.2). To obtain the auto-correlation function, we apply linear response theory (Hutt and Longtin 2009) and find

$$C_{LFP}(x, \tau) = \frac{Q}{(2\pi)^3} \int_{-\infty}^{\infty} dk \int_{-\infty}^{\infty} d\omega |\tilde{G}(k, \omega)|^2 |\bar{h}_e(\omega)|^2 e^{-i\omega\tau}. \quad (10.15)$$

Here

$$\tilde{G}(k, \omega) = \frac{1}{\sqrt{2\pi}} \left(1 - \sum_{n=0}^{\infty} \mathcal{L}_n(k, \omega) (-i\omega)^n \right)^{-1}$$

is the Fourier transform of the Green function with

$$\begin{aligned} \mathcal{L}_n(k, \omega) &= \frac{1}{n!} \left(-\frac{1}{v} \right)^n \int_0^{\infty} dt (a_e \delta_E h_e(t) \tilde{K}_e^n(k) - a_i \delta_I f \omega_0^2 h_i(t) \tilde{K}_i^n(k)) e^{i\omega t}, \\ \tilde{K}^n(k) &= \int_{\Omega} dz K(z) |z|^n e^{-ikz}, \\ \bar{h}_e(\omega) &= \int_0^{\infty} dt h_e(t) e^{i\omega t}. \end{aligned}$$

Then applying the Wiener–Khinchine theorem the power spectrum is computed to be

$$P_{LFP}(x, \nu) = \frac{Q}{(2\pi)^{7/2}} \int_{-\infty}^{\infty} dk |\tilde{G}(k, \nu)|^2 |\bar{h}_e(\nu)|^2. \quad (10.16)$$

with the frequency $\nu = \omega/2\pi$. Equations (10.15) and (10.16) reveal that the correlation function and the power spectrum are independent of the spatial location which reflects the spatial homogeneity of the population.

To obtain the power spectrum of the EEG, we take into account the large distance of the EEG-electrode from the neural sources and the spatial low-pass filtering by the scalp and bone (Srinivasan et al. 1998; Nunez and Srinivasan 2006). Then as a first good approximation the EEG activity represents the spatial summation of electric activity $u_{EEG}(t) = \int_{\Omega} dx u(x, t)$. Here we assume that the EEG-electrodes are far from the neural population compared to the spatial extent of the population. This is reasonable since EEG is measured on the scalp, which typically has a distance of a few centimeters from neural areas with a diameter of a few millimeters.

Assuming the external input as the excitatory synaptic response to uncorrelated random fluctuations, we obtain finally

$$C_{EEG}(\tau) = Q(2\pi)^2 \int_{-\infty}^{\infty} d\omega |\tilde{G}(0, \omega)|^2 |\bar{h}_e(\omega)|^2 e^{-i\omega\tau}, \quad (10.17)$$

$$P_{EEG}(\nu) = \frac{Q}{\sqrt{2\pi}} |\tilde{G}(0, \nu)|^2 |\bar{h}_e(\nu)|^2 \quad (10.18)$$

with the fluctuation strength Q . Equation (10.18) represents the power spectrum of the EEG measured on the scalp and, hence, the quantity that is measured in general anaesthesia. The advantage of this detailed mathematical formulation is the possibility of an analytical study of the bi-phasic power spectrum behavior. This study

has been performed in a recent work (Hutt and Longtin 2009) and conditions for the occurrence of the bi-phasic spectrum have been derived analytically.

10.2.4.2 The Bi-phasic Spectrum

At first we impose the condition that the power increases at low frequencies when increasing the propofol concentration, i.e. $dP_{EEG}(0)/dp > 0$. For the triple solution case, this condition yields

$$a_e/a_i > e^{-\bar{c}\eta} \left(\frac{1-\rho}{1-\rho e^{\bar{c}\eta}} \left(\frac{1+\rho e^{\bar{c}\eta}}{1+\rho} \right)^3 f + \frac{1-\delta_E a_e + \delta_I a_i f}{S_m \bar{c} a_i} \frac{(1+\rho e^{\bar{c}\eta})^3}{(1+\rho)(1-\rho e^{\bar{c}\eta})} \right) \quad (10.19)$$

with $\rho(p) = \exp(-\bar{c}(\bar{V}_- - \Theta_I))$ and $\eta = \Theta_E - \Theta_I > 0$. We find that the parameter regime of the power enhancement is large for shallow firing rate functions (Hutt and Longtin 2009). Figure 10.4(a) shows the power spectrum enhancement for the triple solution case and we observe a bi-phasic behavior in the spectrum.

To extend the imposed conditions on the power spectrum, the experimental findings also stipulate the decrease of power at large frequencies for large values of p . Hence the condition for a power increase at low frequencies and a power decrease at high frequencies read $dP_{EEG}(0)/dp > 0$ and $dP_{EEG}(v)/dp < 0$, $v \gg 0$, respectively. For a large but finite axonal conduction speed, we find the conditions (Hutt and Longtin 2009)

$$\begin{aligned} dP_{EEG}(0)/dp > 0 &\rightarrow a_e/a_i > \frac{\partial}{\partial p} (f(p)\delta_I(p)) \Big/ \frac{\partial \delta_E(p)}{\partial p}, \\ dP_{EEG}(v)/dp < 0 &\rightarrow \frac{d\mathcal{L}_{0,r}}{dp} (1 - \mathcal{L}_{0,r}) > 0 \end{aligned} \quad (10.20)$$

with

$$\begin{aligned} \mathcal{L}_{0,r} &= A_e(v)\delta_E(p) - A_i(p, v)\delta_I(p)f(p)\omega_0^2(p), \\ A_e(v) &= \frac{1 - (2\pi v)^2}{1 + (2\pi v)^2(\gamma_e^2 - 2) + (2\pi v)^4}, \\ A_i(p, v) &= \frac{\omega_0^2(p) - (2\pi v)^2}{\omega_0^4(p) + (2\pi v)^2(\gamma_i^2(p) - \omega_0^2(p)) + (2\pi v)^4}. \end{aligned}$$

The conditions (10.20) define the parameter set for bi-phasic behavior. We focus on the single solution case and apply a numerical parameter search in \bar{c} , a_i , β_1 which satisfies conditions (10.20) considering the result $\beta_2 = 8.5\beta_1$ from Sect. 10.2.2. Figure 10.4(b) presents the spectral power enhancement for a set of parameters obtained numerically. The power in the δ , θ and α band exhibits a sequential increase and decrease of power in according to experiments. Moreover the maxima of the α and δ , θ power occur at $p \approx 1.4$ and $p \approx 1.6$ and thus at concentrations 1 μM ($\sim 0.5 \mu\text{g}$) and

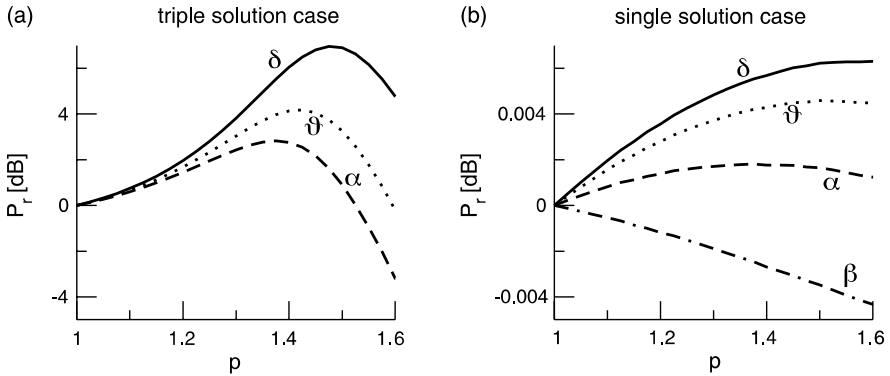

Fig. 10.4 Spectral power enhancement $P_e(p)$ for the triple (a) and single (b) solution case. Here it is $P_e(p) = 10 \log_{10}(P_{EEG}(p)/P_{EEG}(p=1))$ in the corresponding frequency bands, and the frequency bands are defined in the intervals [0.1 Hz; 4 Hz] (δ -band), [4 Hz; 8 Hz] (θ -band), [8 Hz; 12 Hz] (α -band) and [12 Hz; 20 Hz] (β -band). Parameters are (a) $\Theta_E = -50$ mV, $\Theta_I = -60$ mV, $c_e = c_i = 0.114$ /mV and $a_i = 1.4$ mV s on the top branch, (b) $\Theta_E = \Theta_I = -60$ mV, $c_e = c_i = 0.038$ /mV and $a_i = 0.2$ mV s. Other parameters are $a_e = 1.0$ mV s, $\beta_2 = 5780$ Hz, $\beta_1 = 680$ Hz, $\alpha_1 = 222$ Hz, $\alpha_2 = 5000$ Hz

2 μ M (~ 1.1 μ g), respectively. These concentrations are similar to medical effect-site concentrations during surgery and Fig. 10.4(b) shows good accordance to the bi-phasic behavior observed experimentally in general anaesthesia.

10.3 Summary

The presented work introduces a novel neural population model to describe mathematically the effect of the anaesthetic propofol on the EEG-power spectrum. The study shows a bi-phasic spectrum in the presence of both multiple states and a single state.

On the one hand, it can be concluded that multiple states are not necessary to gain a bi-phasic power spectrum. Since the loss of consciousness (LOC) during anaesthesia is related to the bi-phasic behavior, one may argue that LOC may occur in the presence of a single stable state. Consequently the jump between stable states at the LOC as argued by Steyn-Ross et al. is not necessary to observe the LOC.

On the other hand, a very recent experimental study on insects and mammals of Friedman et al. (1992) demonstrates that changing the anaesthetic concentration in neural tissue induces phase transitions with hysteresis. This transition is independent of the pharmacodynamics and -kinetics of the agent. Consequently increasing the anaesthetic agent concentration yields a drop of neural population activity from high activity to low activity, which may explain the loss of consciousness as a loss of neural activity.

More future experimental and theoretical work on this topic will elucidate the details of the LOC.

References

- Agmon-Sir H, Segev I (1993) Signal delay and input synchronization in passive dendritic structures. *J Neurophysiol* 70:2066–2085
- Amzica F, Steriade M (1998) Electrophysiological correlates of sleep delta waves. *Electroencephalogr Clin Neurophysiol* 107:69–83
- Andrews D, Leslie K, Sessler D, Bjorksten A (1997) The arterial blood propofol concentration preventing movement in 50 incision. *Anesth Analg* 85:414–419
- Antkowiak B (1999) Different actions of general anesthetics on the firing patterns of neocortical neurons mediated by the GABAA-receptor. *Anesthesiology* 91:500–511
- Bojak I, Liley D (2005) Modeling the effects of anesthesia on the electroencephalogram. *Phys Rev E* 71:041,902
- Coombes S, Venkov N, Shiau L, Bojak I, Liley D, Laing C (2007) Modeling electrocortical activity through improved local approximations of integral neural field equations. *Phys Rev E* 76:051,901
- Franks N, Lieb W (1994) Molecular and cellular mechanisms of general anesthesia. *Nature* 367:607–614
- Freeman W (1979) Nonlinear gain mediating cortical stimulus-response relations. *Biol Cybern* 33:237–247
- Freeman W (1992) Tutorial on neurobiology: from single neurons to brain chaos. *Int J Bifurc Chaos* 2(3):451–482
- Friedman EB, Sun Y, Moore JT, Hung HT, Meng QC, Perera P, Joiner WJ, Thomas SA, Eckenhoff RG, Sehgal A, Kelz MB (1992) A conserved behavioral state barrier impedes transitions between anesthetic-induced unconsciousness and wakefulness: evidence for neural inertia. *PLoS ONE* 5(7):e11903
- Gerstner W, Kistler W (2002) *Spiking neuron models*. Cambridge University Press, Cambridge
- Hutt A (2007) Generalization of the reaction-diffusion, Swift-Hohenberg, and Kuramoto-Sivashinsky equations and effects of finite propagation speeds. *Phys Rev E* 75:026,214
- Hutt A, Atay F (2005) Analysis of nonlocal neural fields for both general and gamma-distributed connectivities. *Physica D* 203:30–54
- Hutt A, Atay F (2007) Spontaneous and evoked activity in extended neural populations with gamma-distributed spatial interactions and transmission delay. *Chaos Solitons Fractals* 32:547–560
- Hutt A, Frank T (2005) Critical fluctuations and $1/f$ -activity of neural fields involving transmission delays. *Acta Phys Pol A* 108(6):1021
- Hutt A, Longtin A (2009) Effects of the anesthetic agent propofol on neural populations. *Cogn Neurodyn* 4(1):37–59
- Kitamura A, Marszalec W, Yeh J, Narahashi T (2002) Effects of halothane and propofol on excitatory and inhibitory synaptic transmission in rat cortical neurons. *J Pharmacol* 304(1):162–171
- Koch C (1999) *Biophysics of computation*. Oxford University Press, Oxford
- Kuizenga K, Wierda J, Kalkman C (2001) Biphasic EEG changes in relation to loss of consciousness during induction with thiopental, propofol, etomidate, midazolam or sevoflurane. *Br J Anaesth* 86(3):354–360
- Liley D, Bojak I (2005) Understanding the transition to seizure by modeling the epileptiform activity of general anaesthetic agents. *J Clin Neurophysiol* 22:300–313
- Liley D, Cadusch P, Wright J (1999) A continuum theory of electrocortical activity. *Neurocomputing* 26–27:795–800
- Longnecker DE, Brown DL, Newman MF, Zapol WM (eds) (2008) *Anesthesiology*. McGraw Hill, New York
- Marik P (2004) Propofol: therapeutic indications and side-effects. *Curr Pharm Des* 10(29):3639–3649
- Molaee-Ardekani B, Senhadji L, Shamsollahi M, Vosoughi-Vahdat B, Wodey E (2007) Brain activity modeling in general anesthesia: enhancing local mean-field models using a slow adaptive firing rate. *Phys Rev E* 76:041,911

- Nunez P (1995) *Neocortical dynamics and human EEG rhythms*. Oxford University Press, New York
- Nunez P, Srinivasan R (2006) *Electric fields of the brain: the neurophysics of EEG*. Oxford University Press, New York
- Rampil I (1998) A primer for EEG signal processing in anaesthesia. *Anesthesiology* 89:980–1002
- Roxin A, Brunel N, Hansel D (2006) Rate models with delays and the dynamics of large networks of spiking models. *Prog Theor Phys* 161:68–85
- Srinivasan R, Nunez P, Silberstein R (1998) Spatial filtering and neocortical dynamics: estimates of EEG coherence. *IEEE Trans Biomed Eng* 45:814–827
- Steyn-Ross M, Steyn-Ross D, Sleight J, Wilcocks L (2001) Toward a theory of the general-anesthetic-induced phase transition of the cerebral cortex: I. a thermodynamic analogy. *Phys Rev E* 64:011,917J
- Steyn-Ross M, Steyn-Ross D, Sleight J (2004) Modelling general anaesthesia as a first-order phase transition in the cortex. *Prog Biophys Mol Biol* 85(2–3):369–385

Chapter 11

In-vivo Electrophysiology of Anesthetic Action

F. von Dincklage and B. Rehberg

11.1 Introduction

Since the introduction of general anesthesia over a century ago several concepts have been developed to clinically define the anesthetic state and quantitative measures of anesthetic depth. A modern definition presented by Shafer and Stanski defines anesthetic depth generally as the probability of non-response to stimulation (Shafer and Stanski 2008). Anesthetic depth in this concept is therefore determined by the strength and nature of the applied stimulus as well as the strength and nature of the observed response, which have to be evaluated in the context of the drug concentrations at the sites of action that blunt the responsiveness.

After reducing all possible stimuli and all possible responses to only the clinical relevant ones, the matrix that combines the remaining parameters can be regarded as a precise tool for a quantitative evaluation of the anesthetic depth. This tool would still have to include many different stimulation modalities ranging from verbal stimuli over innocuous contact stimuli like touching or shaking to noxious stimuli like incision, laryngoscopy and intubation. Also on the response side many different types of reaction would have to be included ranging from verbal responses over memory formation, movement responses, tearing and sweating to hemodynamic responses.

To simplify this complex tool, one can divide stimuli and responses into classes in which stimuli and responses of the same modality are grouped together, and which can be assumed to follow a rank order in which they are suppressed by anesthetic drugs. Stimuli for example can be roughly divided into the classes of innocuous and noxious stimuli. Innocuous stimuli would follow a rank order, in which reactions to

F. von Dincklage (✉)

Department of Anesthesiology, Charité, Universitätsmedizin Berlin, Berlin, Germany

e-mail: falk.von-dincklage@charite.de

light touch or calling the name would precede shaking or shouting, since the latter ones are less readily suppressed by anesthetics. In a similar way noxious stimuli follow a rank order in which a pinprick would precede an incision, which again would precede laryngoscopy and intubation. Responses can also be divided in categories like verbal responses, movement reactions, memory formation, autonomous or sudomotor responses and hemodynamic responses. These could again be put in some sort of rank order in that the loss of verbal responses can be expected to precede the loss of purposeful movement. But between the different categories the order of suppression can differ according to which drugs are used for anesthesia. Opioids for example seem to suppress hemodynamic responses at lower concentrations than movement responses, while hypnotics show the inverse order of suppression (Kazama et al. 1997, 1998a, 1998b).

So how is the state of non-responsiveness to the stimuli achieved by anesthetics? In the model described by Shafer and Stanski at least two components are needed to create the anesthetic state: hypnosis, achieved through the use of hypnotics as propofol or inhalational agents, and anti-nociception accomplished with opioids, nitrous oxide or peripheral analgesic procedures. To achieve unconsciousness for example, these components are regarded to act together in a hierarchical order where anti-nociceptive substances attenuate the transmission of sensation to the cortex in the spinal cord and other sub-cortical sites of action, see Fig. 11.1. This reduces the arousal effect of stimuli and therefore reduces the amount of hypnotic required to suppress thalamo-cortical information processing and thus maintaining the state of unconsciousness. The state of immobility in response to noxious stimulation on the other hand is mainly mediated through the spinal cord, rather than the cortex (Rampil 1994; Rampil et al. 1993). But again the same hierarchical model can be applied, in which anti-nociceptive substances are considered to attenuate the effect of the noxious sensation on the spinal cord, reducing the amount of hypnotic needed (or nitrous oxide) to suppress the excitability of the spinal motoneurons to maintain the state of immobility.

Based on this hierarchical model, every of the above described clinical responses to the different stimuli can be mathematically modeled as a hierarchical combination of the effects on the strength of the input (like anti-nociceptive effects) and the effects reducing the excitability of the structure mediating the response (like hypnotic effects or motor-inhibiting effects). However, the relative potency of the different effects has to be adjusted, depending on the quality of the investigated stimuli and responses. Verbal reactions or memory formation after innocuous stimuli would be hardly affected by anti-nociceptive substances, but very strongly by hypnotic effects. Autonomous responses to noxious stimuli on the other hand are much stronger effected by anti-nociceptive substances than by hypnotic effects.

So how can the hypnotic, anti-nociceptive or motor suppressant effects of anesthetics be quantified to perform this hierarchical modeling? One very common way would be to use the applied drug concentrations, reducing substances to their main effects. In this case substances like propofol or volatile anesthetics would be regarded as pure hypnotics and opioids as pure anti-nociceptive substances. Another way to quantify the different effects would be the use of physiological surrogate

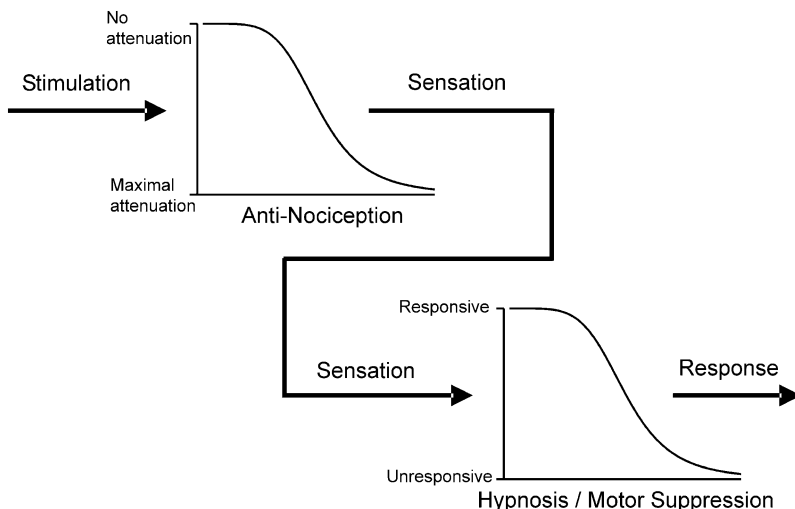

Fig. 11.1 Hierarchical interaction model. The Stimulus–Response relationship under anesthesia can be modeled using opioid and hypnotic concentrations or other surrogates for anti-nociception, hypnosis and motor suppression. Model adapted from Shafer and Stanski (2008)

parameters, which has the advantage that the secondary and minor effects of anesthetics are not neglected.

In the following two sections we would like to present some electrophysiological methods which can be used as surrogate parameters for different effects of anesthetics. The second sub-section will focus on EEG-based methods, which predominately reflect the anesthetic action in the brain, while the third sub-section will focus on electrophysiological reflexes, which predominately reflect the anesthetic action in the spinal cord. The fourth sub-section will introduce the concept of combination of electrophysiological methods with functional imaging, aiming to validate the specificity of the proposed surrogate parameters.

11.2 EEG-Based Methods

Since the first experiments with electroencephalography (EEG) in man by Berger it is known that anesthetics alter the EEG, and since then EEG analysis has accompanied the development of anesthesia. Mostly, the EEG has been used by anesthesiologists to monitor what is called “anesthetic depth”, although the concept of anesthetic depth has always been debated (see review in Palanca et al. 2009) and has often been confused with “level of consciousness”. Only in recent years theories have prevailed in which “anesthetic depth” is viewed as a two-dimensional representation of two different components (Kent and Domino 2009). Shafer and Stanski have defined depth of anesthesia as the “drug-induced probability of non-response to a stimulus, calibrated against the strength of the stimulus”, whereby the stimulus is sequentially

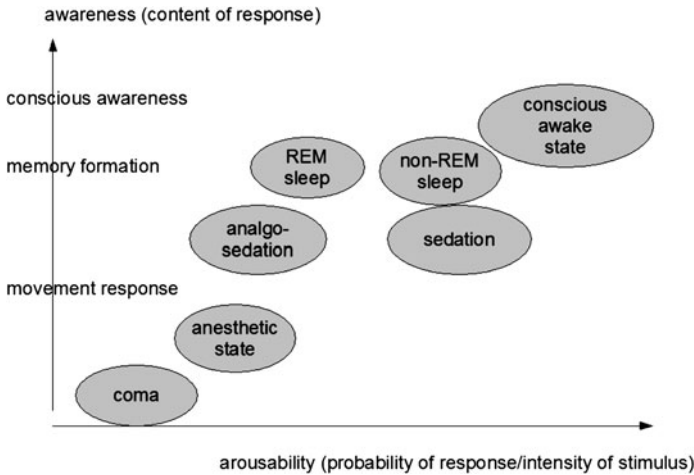

Fig. 11.2 Two-dimensional model of anesthetic depth (or consciousness). Consciousness or anesthesia as non-consciousness can be seen as a state defined by awareness, which is suppressed by the hypnotic effect of anesthetic drugs, and arousability, which is suppressed by the analgesic effect. Arousability itself is defined by the relation between the probability of a response and the intensity of the arousing stimulus. The addition of an analgesic to a regime used for sedation for example will not alter the content of the possible response, but reduce the probability of the response to a particular stimulus (e.g. memory formation following intratracheal suctioning). Model adapted from Boly et al. (2008) and Palanca et al. (2009)

attenuated by analgesics (primarily on a sub-cortical level) and by hypnotics (on a thalamo-cortical level) (Shafer and Stanski 2008). Thus the interaction between the effect of analgesics (analgesia or anti-nociception) and that of hypnotics (hypnosis) is seen as fundamental to the definition of anesthetic depth.

In parallel, studies on patients in a vegetative state have shown that consciousness itself can be divided in two components, “awareness” denoting the *content* of consciousness per se, and “arousal”, denoting the *level* of consciousness (Boly et al. 2008), see Fig. 11.2. During anesthesia, awareness is suppressed by hypnotics, whereas arousal is attenuated by analgesics, leading again to the two-dimensional interaction of analgesics and hypnotics.

Next to the concept of “anesthetic depth”, the methodology of EEG-based analysis of CNS suppression by anesthetics has also evolved. Concerning the monitoring of “depth of anesthesia”, combinations of different EEG parameters, e.g. as implemented in the “bispectral index BIS” (Rampil 1998), have proved superior to single parameters. Combination with parameters from auditory evoked responses leads to an even better correlation with anesthetic depth, at least in volunteers during single-agent anesthesia (Horn et al. 2009). However, these combination indices do not yield insight in the mechanisms by which anesthetics produce unconsciousness.

The subparameters of these indices, such as median frequency, beta ratio, burst suppression ration, and also the nonlinear parameters such as correlation dimension (Widman et al. 2000) or approximate entropy (Bruhn et al. 2000), correlate with the synchronization of cortical activity or hyperpolarization of the thalamus. How-

ever, they merely reflect the concentration-dependent anesthetic effect, but do not indicate loss of consciousness itself. It has long been suggested that suppression of thalamic activity by anesthetic leads to unconsciousness (see discussion in Alkire et al. 2008), but the recent discovery that thalamic EEG activity, recorded from implanted electrodes, is much later suppressed during anesthetic induction compared to cortical EEG activity, is currently the main argument against a leading role of the thalamus (Velly et al. 2007).

Recently it has been hypothesized that the loss of long-range cortico-cortical phase synchronization of neuronal activity is ultimately responsible for anesthetic-induced loss of consciousness (Alkire et al. 2008). Indeed, at least isoflurane has been shown to suppress synchrony between left and right frontal cortices as well as between occipital and frontal regions (Imas et al. 2006). Nevertheless, as mentioned above, a change in “awareness” induced by the hypnotic effect of anesthetics is not sufficient to fully describe the anesthetic effect, without a sufficient suppression of the state of “arousal” an external stimulus will be able to change the state of awareness in an instant. Until now no EEG-derived parameter exists which can measure the state of arousal (or “arousability”). Although opioid analgesics do have an effect on the EEG, this is indistinguishable from the non-analgesic hypnotic effect. To measure “arousability”, which is in effect the balance between (nociceptive) stimulation and (anti-nociceptive) suppression, it is necessary to analyze responses evoked by a strong, potentially painful, stimulus. Since analgesics primarily act at a sub-cortical level, it seems appropriate to use responses recorded at this sub-cortical level, too, such as electrophysiological reflexes.

11.3 Electrophysiological Reflexes

The effects of anesthetics are mediated through various sites across the human body and the central nervous system. The electroencephalogram as described in the previous section can be used to study those effects that are predominately located in the brain, but for the investigation of peripheral actions or actions located in the spinal cord a different methodology is required. This is particularly important for the effect of analgesic drugs, which primarily act a sub-cortical level. Electrophysiological reflexes have been applied for the study of spinal pathways in animals and humans since the early last century (Pierrot-Deseilligny 2005). In this section we would like to present some exemplary methods which already have been used to quantify spinal effects of anesthetics in humans.

11.3.1 *The H Reflex*

The H reflex (or Hoffmann reflex) can be regarded as the electrophysiological analog of the tendon jerk. It is elicited through electrical stimulation of Ia afferents,

Fig. 11.3 Recording paradigm of the soleus H reflex. Electrical stimulation of Ia nerve afferents of the soleus muscle excite homonymous motoneurons in the spinal cord, which leads to a muscle potential recordable over the soleus muscle

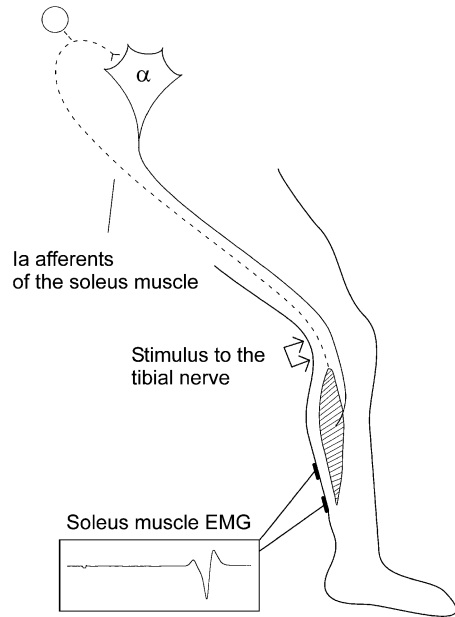

coming from the muscle spindle, which results in a contraction of the corresponding muscle due to the activation of homonymous motoneurons, cf. Fig. 11.3. Most commonly the tibial nerve is used as the stimulation site producing a reflex response in the soleus muscle. Investigation of the H reflex allows one to assess changes in excitability of the motoneurone pool. Several studies have been performed using the H reflex under anesthesia as a tool to evaluate the drug induced changes in motoneuronal excitability (von Dincklage et al. 2006; Rehberg et al. 2004; Kerz et al. 2001; Kammer et al. 2002; Baars et al. 2006a, 2007, 2009).

Also the H reflex can be used as a test reflex, to investigate the effects of several conditioning volleys in peripheral afferents or descending tracts. Heteronymous facilitation of the soleus H reflex via stimulation of the femoral nerve for example can be used to quantify the GABAergic presynaptic inhibition on Ia fibers (Baars et al. 2006c, 2007; Hultborn et al. 1987), see Fig. 11.4. Similar conditioning methods can be applied to investigate the reciprocal Ia and Ib inhibition, the recurrent inhibition or the homonymous facilitation (Pierrot-Deseilligny 2005; Katz and Pierrot-Deseilligny 1999; Crone et al. 1987).

11.3.2 The F Wave

After supramaximal stimulation of a nerve containing motor axonal fibers, a small late response is elicited in the target muscle, which has been termed F wave. The F wave is believed to be evoked by antidromic activation of motoneurons through stimulation of their axons. Since the F wave may only be produced if the axon

Fig. 11.4 Recording paradigm of the heteronymous facilitation of the soleus H reflex. The soleus H reflex which is recorded as described above can be facilitated by appropriately timed stimulation of the femoral nerve. Exact timing of the stimuli ensures a mono-synaptic facilitation which is uniquely influenced by GABAergic presynaptic inhibition. Under these circumstances can changes in heteronymous facilitation be ascribed to changes in presynaptic inhibition

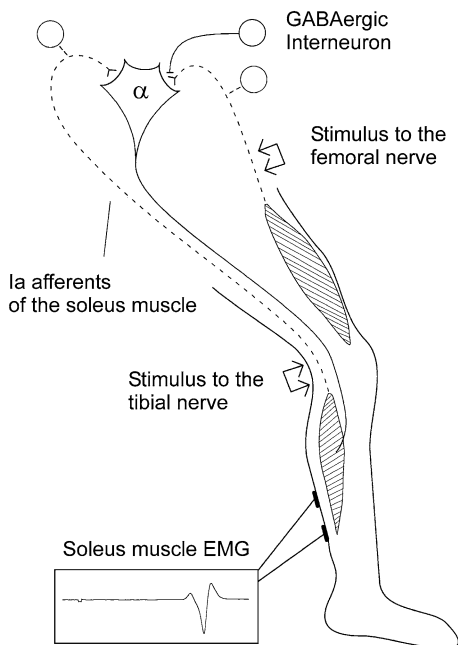

hillock and proximal axon are ready to be excited at the moment when the antidromic activation potential discharges the soma, it is suggested that the size of the F wave response correlates with the excitability of the motoneurone pool (Fisher 1992).

Compared to the H reflex the F wave is considered as being much less sensible in detecting changes in motoneuronal excitability. However, since in contrast to the H reflex for the F wave response large motor units are preferentially recruited, the investigation of F waves can provide additional insight into the inhibitory effects of anesthetics on a different part of the motoneurone pool (Hultborn and Nielsen 1995). The F wave has been used in several studies to investigate the effects of anesthetics (Zhou et al. 1997; Kakinohana and Sugahara 2006; Kakinohana et al. 2006; Dominguez et al. 2005; Baars et al. 2006b, 2005).

11.3.3 The Nociceptive Flexion Reflex

The nociceptive flexion reflex is a polysynaptic spinal withdrawal reflex that is elicited by stimulation of nociceptive nerve afferents, see Fig. 11.5. A common way to assess the nociceptive flexion reflex is the monitoring of biceps femoris muscle activity using an electromyogram during the application of electrocutaneous stimuli to the ipsilateral sural nerve (Sandrini et al. 2005).

The nociceptive flexion reflex can be used as a tool for the investigation of nociception in conscious and unconscious subjects. Generally it can be applied in two

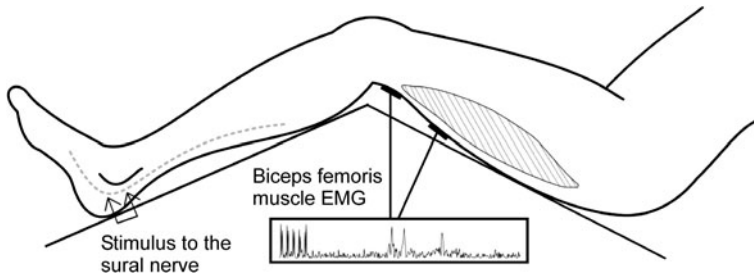

Fig. 11.5 Recording paradigm of the nociceptive flexion reflex. Stimulation of the sural nerve at its retromalleolar pathways elicits a muscle potential over the biceps femoris muscle. The RIII component of the reflex correlates with the subjective pain sensation and can therefore be possibly used as a surrogate for nociception

different ways: either can the reflex threshold be used as an objective measure of the nociceptive threshold or changes in the magnitude of the reflex following constant suprathreshold stimuli can be used to assess changes in the nociceptive responding.

Several studies have been performed investigating the influence of anesthetics on the nociceptive flexion reflex as a surrogate of immobility and possibly also as a surrogate of nociception under anesthesia (Baars et al. 2009; von Dincklage et al. 2009, 2010).

11.3.4 The Nociception Specific Blink Reflex

The blink reflex is a trigeminofacial brain-stem reflex and can therefore be used as a noninvasive tool to study trigeminal transmission in humans. It is elicited by stimulation of the supraorbital nerve and assessed by an electromyogram of the orbicularis oculi muscles. To increase the nociceptive specificity of the reflex a special concentric planar electrode can be used for stimulation which produces a high current density in superficial skin layers already at low current intensities, therefore predominately exciting superficial A delta fibers (Kaube et al. 2000). This nociceptive blink reflex paradigm is used in experimental pain research as a tool to evaluate the modulation of pain perception by pharmacological or physiological influences and could therefore be applied as a tool to quantify the influence of anesthetics on trigeminal nociceptive processing as the nociceptive flexion reflex can be used to investigate spinal nociceptive processing.

Summarizing this section, the above mentioned reflexes can be used to measure the excitability of different spinal and sub-cortical structures. Especially the nociceptive responses appear to be appropriate measures of the “arousability” of the central nervous system during anesthesia and thus complement EEG-derived parameters indicating the state of awareness. Interestingly, these nociceptive responses are also influenced during sleep (Sandrini et al. 2001).

11.4 Combining Clinical Electrophysiology and Functional Imaging

The introduction of modern functional imaging methods like positron emission tomography (PET) and functional magnetic resonance imaging (fMRI) has made a tremendous impact in diverse fields such as cognitive neuroscience, psychiatry and psychology. However, only during the recent years these have been applied to gain more insight into the actions underlying general anesthesia.

The main advantage that these rather new methods provide is the good spatial resolution for the imaging of effects which are specifically linked to neuronal activity. In the case of positron emission tomography the regional glucose metabolism (Phelps et al. 1979; Huang et al. 1980) as well as the regional cerebral blood flow (Raichle et al. 1983; Herscovitch et al. 1983) can be investigated as parameters of regional neuronal activity. In the case of functional magnetic resonance imaging neuronal activity can be quantified by the blood oxygen dependent (BOLD) effects (Logothetis et al. 2001; Babiloni et al. 2009).

While these imaging parameters are assumed as reliably correlating with neuronal activity in the awake subject, the cerebrovascular effects of anesthetics pose a serious challenge for functional imaging and especially fMRI studies under anesthesia. Inhaled anesthetics for example are potent cerebral vasodilators which can result in saturating the BOLD response (Matta et al. 1995, 1999). Also indirect effects of anesthetics on the regional blood flow like changes in the partial pressure of carbon dioxide due to hypoventilation could confound the BOLD signal (Hoge et al. 1999). However, different endpoints of general anesthesia like hypnosis or anti-nociception can be imaged as the reduction of activity in different areas of the brain and the spinal cord (Fiset et al. 1999; Antognini et al. 1997; Alkire et al. 2000). Therefore the functional activity in these areas can be used as a specific surrogate parameter for the respective anesthesia endpoint. This is especially of interest for those endpoints that are difficult to evaluate clinically, like anti-nociception under anesthesia, or for those endpoints that show a sporadic occurrence like implicit and explicit memory formation under anesthesia.

Unfortunately the monetary and personnel expense of functional imaging studies under anesthesia as well as the impossibility to perform PET or fMRI imaging in the normal clinical setting in the operating room prevent that these precise surrogate parameters or “first level” surrogates can be broadly applied in clinical studies. Therefore further surrogate parameters for these surrogates, or “second level” surrogate parameters are required, which may be evaluated without the mentioned restrictions.

Electrophysiological methods as described in the previous sections hold the advantage of simple applicability and low costs, as well as a high temporal resolution compared to functional imaging, which qualifies them as possible second level surrogates. However, since such second level surrogates are not as closely linked to the physiological processes as first level surrogates, a validation of the concordance between the surrogates is required, before the second level surrogate could be used as a monitoring instrument. If a second level surrogate would indeed show a high

specificity and sensibility in concordance with the first level surrogate, it would allow for a continual quantification of those anesthetic effects in the clinical setting, which are difficult to evaluate by clinical means. Such a validation of concordance between surrogates is complicated by the fact that the different endpoints of general anesthesia are generally induced using combinations of various drugs. Therefore a validation study would have to investigate the relationship of the endpoint parameter or the first level surrogate with the second level surrogate for each of the drugs, as well as for the interaction effects. This is necessary to prevent overrating a surrogate parameter which shows a very good accuracy for every single drug, but which fails for others or when different drugs are combined.

Blood pressure as a simple example correlates with the dose of the propofol or the dose of the opioid remifentanyl. Since movement to noxious stimulation is also dose-dependent for both of these drugs one can expect that blood pressure can be used as a surrogate for immobility during anesthesia using either propofol or remifentanyl. However, since the relative effect of each of the drugs on the blood pressure is different compared to the relative effect of each drug on immobility, blood pressure can be expected to perform with a far worse accuracy when used as a surrogate for movement to noxious stimulation during anesthesia induced with a combination of both drugs.

11.5 Discussion

In summary, modern functional imaging methods provide the means for a specific quantification of anesthetic effects in the central nervous system. By combining these imaging techniques with surrogates that can be investigated with less effort and expenses like the electrophysiological methods described in the previous sections, instruments can be created that allow a quantification of those anesthetic effect in the clinical setting which are difficult to evaluate with clinical means. However, the design of validation studies has to incorporate the relative effects of different drugs that can be used to induce the investigated anesthetic endpoint as well as interaction effects between the drugs.

References

- Alkire MT, Haier RJ, Fallon JH (2000) Toward a unified theory of narcosis: brain imaging evidence for a thalamocortical switch as the neurophysiologic basis of anesthetic-induced unconsciousness. *Conscious Cogn* 9:370–386
- Alkire MT, Hudetz AG, Tononi G (2008) Consciousness and anesthesia. *Science* 322:876–880
- Antognini JF, Buonocore MH, Disbrow EA, Carstens E (1997) Isoflurane anesthesia blunts cerebral responses to noxious and innocuous stimuli: a FMRI study. *Life Sci* 61:349–354
- Baars JH, Kalisch D, Herold KF, Hadzidiakos DA, Rehberg B (2005) Concentration-dependent suppression of f-waves by sevoflurane does not predict immobility to painful stimuli in humans. *Br J Anaesth* 95:789–797

- Baars JH, Dangel C, Herold KF, Hadzidiakos DA, Rehberg B (2006a) Suppression of the human spinal h-reflex by propofol: a quantitative analysis. *Acta Anaesthesiol Scand* 50:193–200
- Baars JH, Tas S, Herold KF, Hadzidiakos DA, Rehberg B (2006b) The suppression of spinal f-waves by propofol does not predict immobility to painful stimuli in humans. *Br J Anaesth* 96(1):118–126
- Baars JH, von Dincklage F, Reiche J, Rehberg B (2006c) Propofol increases presynaptic inhibition of Ia afferents in the intact human spinal cord. *Anesthesiology* 104:798–804
- Baars JH, Benzke M, von Dincklage F, Reiche J, Schlattmann P, Rehberg B (2007) Presynaptic and postsynaptic effects of the anesthetics sevoflurane and nitrous oxide in the human spinal cord. *Anesthesiology* 107:553–562
- Baars JH, Mager R, Dankert K, Hackbarth M, von Dincklage F, Rehberg B (2009) Effects of sevoflurane and propofol on the nociceptive withdrawal reflex and on the h reflex. *Anesthesiology* 111:72–81
- Babiloni C, Pizzella V, Gratta CD, Ferretti A, Romani GL (2009) Fundamentals of electroencephalography, magnetoencephalography, and functional magnetic resonance imaging. *Int Rev Neurobiol* 86:67–80
- Boly M, Phillips C, Tshibanda L, Vanhaudenhuyse A, Schabus M, Dang-Vu TT, Moonen G, Hustinx R, Maquet P, Laureys S (2008) Intrinsic brain activity in altered states of consciousness: how conscious is the default mode of brain function? *Ann NY Acad Sci* 1129:119–129
- Bruhn J, Roepcke H, Hoefft A (2000) Approximate entropy as an electroencephalographic measure of anesthetic drug effect during desflurane anesthesia. *Anesthesiology* 92:715–726
- Crone C, Hultborn H, Jespersen B, Nielsen J (1987) Reciprocal Ia inhibition between ankle flexors and extensors in man. *J Physiol* 389:163–185
- Dominguez C, Carstens E, Antognini JF (2005) Carbon dioxide depresses the *f* wave by a central, not peripheral, mechanism during isoflurane anesthesia. *Anesth Analg* 100:398–403
- Fiset P, Paus T, Daloz T, Plourde G, Meuret P, Bonhomme V, Hajj-Ali N, Backman SB, Evans AC (1999) Brain mechanisms of propofol-induced loss of consciousness in humans: a positron emission tomographic study. *J Neurosci* 19:5506–5513
- Fisher MA (1992) Aaem minimonograph 13: H reflexes and *f* waves: physiology and clinical indications. *Muscle Nerve* 15:1223–1233
- Herscovitch P, Markham J, Raichle ME (1983) Brain blood flow measured with intravenous ^{15}O . I. theory and error analysis. *J Nucl Med* 24:782–789
- Hoge RD, Atkinson J, Gill B, Crelier GR, Marrett S, Pike GB (1999) Investigation of bold signal dependence on cerebral blood flow and oxygen consumption: the deoxyhemoglobin dilution model. *Magn Reson Med* 42:849–863
- Horn B, Pilge S, Kochs EF, Stockmanns G, Hock A, Schneider G (2009) A combination of electroencephalogram and auditory evoked potentials separates different levels of anesthesia in volunteers. *Anesth Analg* 108:1512–1521
- Huang SC, Phelps ME, Hoffman EJ, Sideris K, Selin CJ, Kuhl DE (1980) Noninvasive determination of local cerebral metabolic rate of glucose in man. *Am J Physiol* 238:E69–E82
- Hultborn H, Nielsen JB (1995) H-reflexes and f-responses are not equally sensitive to changes in motoneuronal excitability. *Muscle Nerve* 18:1471–1474
- Hultborn H, Meunier S, Morin C, Pierrot-Deseilligny E (1987) Assessing changes in presynaptic inhibition of i a fibres: a study in man and the cat. *J Physiol* 389:729–756
- Imas OA, Ropella KM, Wood JD, Hudetz AG (2006) Isoflurane disrupts antero-posterior phase synchronization of flash-induced field potentials in the rat. *Neurosci Lett* 402(3):216–221
- Kakinohana M, Sugahara K (2006) Level of consciousness affects the excitability of spinal motor neurones during propofol sedation in humans. *Br J Anaesth* 96:742–746
- Kakinohana M, Miyata Y, Tomiyama H, Sugahara K (2006) Nitrous oxide can enhance the hypnotic effect, but not the suppression of spinal motor neuron excitability by propofol in humans. *J Anesth* 20:173–178
- Kammer T, Rehberg B, Menne D, Wartenberg H, Wenningmann I, Urban BW (2002) Propofol and sevoflurane in subanesthetic concentrations act preferentially on the spinal cord: evidence from multimodal electrophysiological assessment. *Anesthesiology* 97:1416–1425

- Katz R, Pierrot-Deseilligny E (1999) Recurrent inhibition in humans. *Prog Neurobiol* 57:325–355
- Kaube H, Katsarava Z, Kaufer T, Diener H, Ellrich J (2000) A new method to increase nociception specificity of the human blink reflex. *Clin Neurophysiol* 111:413–416
- Kazama T, Ikeda K, Morita K (1997) Reduction by fentanyl of the cp50 values of propofol and hemodynamic responses to various noxious stimuli. *Anesthesiology* 87:213–227
- Kazama T, Ikeda K, Morita K (1998a) The pharmacodynamic interaction between propofol and fentanyl with respect to the suppression of somatic or hemodynamic responses to skin incision, peritoneum incision, and abdominal wall retraction. *Anesthesiology* 89:894–906
- Kazama T, Ikeda K, Morita K, Katoh T, Kikura M (1998b) Propofol concentration required for endotracheal intubation with a laryngoscope or fiberscope and its interaction with fentanyl. *Anesth Analg* 86:872–879
- Kent CD, Domino KB (2009) Depth of anesthesia. *Curr Opin Anaesthesiol* 22:782–787
- Kerz T, Hennes HJ, Feve A, Decq P, Filipetti P, Duvaldestin P (2001) Effects of propofol on h-reflex in humans. *Anesthesiology* 94:32–37
- Logothetis NK, Pauls J, Augath M, Trinath T, Oeltermann A (2001) Neurophysiological investigation of the basis of the fMRI signal. *Nature* 412:150–157
- Matta BF, Mayberg TS, Lam AM (1995) Direct cerebrovasodilatory effects of halothane, isoflurane, and desflurane during propofol-induced isoelectric electroencephalogram in humans. *Anesthesiology* 83:980–985
- Matta BF, Heath KJ, Tipping K, Summors AC (1999) Direct cerebral vasodilatory effects of sevoflurane and isoflurane. *Anesthesiology* 91:677–680
- Palanca BJA, Mashour GA, Avidan MS (2009) Processed electroencephalogram in depth of anesthesia monitoring. *Curr Opin Anaesthesiol* 22:553–559
- Phelps ME, Huang SC, Hoffman EJ, Selin C, Sokoloff L, Kuhl DE (1979) Tomographic measurement of local cerebral glucose metabolic rate in humans with (f-18)2-fluoro-2-deoxy-d-glucose: validation of method. *Ann Neurol* 6:371–388
- Pierrot-Deseilligny E (2005) *The circuitry of the human spinal cord*. Cambridge University Press, Cambridge
- Raichle ME, Martin MR, Herscovitch P, Mintun MA, Markham J (1983) Brain blood flow measured with intravenous ^{15}O . II. implementation and validation. *J Nucl Med* 24:790–798
- Rampil IJ (1994) Anesthetic potency is not altered after hypothermic spinal cord transection in rats. *Anesthesiology* 80:606–610
- Rampil IJ (1998) A primer for EEG signal processing in anesthesia. *Anesthesiology* 89:980–1002
- Rampil IJ, Mason P, Singh H (1993) Anesthetic potency (mac) is independent of forebrain structures in the rat. *Anesthesiology* 78:707–712
- Rehberg B, Grunewald M, Baars J, Fuegener K, Urban BW, Kox WJ (2004) Monitoring of immobility to noxious stimulation during sevoflurane anesthesia using the spinal h-reflex. *Anesthesiology* 100:44–50
- Sandrini G, Milanov I, Rossi B, Murri L, Alfonsi E, Moglia A, Nappi G (2001) Effects of sleep on spinal nociceptive reflexes in humans. *Sleep* 24:13–17
- Sandrini G, Serrao M, Rossi P, Romaniello A, Cruccu G, Willer JC (2005) The lower limb flexion reflex in humans. *Prog Neurobiol* 77:353–395
- Shafer SL, Stanski DR (2008) Defining depth of anesthesia. In: Schüttler J, Schwilden H (eds) *Modern anesthetics*. Springer, New York, pp 409–423
- Velly LJ, Rey MF, Bruder NJ, Gouvitsos FA, Witjas T, Regis JM, Peragut JC, Gouin FM (2007) Differential dynamic of action on cortical and subcortical structures of anesthetic agents during induction of anesthesia. *Anesthesiology* 107:202–212
- von Dincklage F, Reiche J, Rehberg B, Baars JH (2006) H-reflex depression by propofol and sevoflurane is dependent on stimulus intensity. *Clin Neurophysiol* 117:2653–2660
- von Dincklage F, Send K, Hackbarth M, Rehberg B, Baars JH (2009) Comparison of the nociceptive flexion reflex threshold and the bispectral index as monitors of movement responses to noxious stimuli under propofol mono-anaesthesia. *Br J Anaesth* 102:244–250
- von Dincklage F, Hackbarth M, Mager R, Rehberg B, Baars JH (2010) Monitoring of the responsiveness to noxious stimuli during anaesthesia with propofol and remifentanyl by using rii reflex threshold and bispectral index. *Br J Anaesth* 104:201–208

- Widman G, Schreiber T, Rehberg B, Hoefft A, Elger C (2000) Quantification of depth of anesthesia by nonlinear time series analysis of brain electrical activity. *Phys Rev E* 62:4898–4903
- Zhou HH, Mehta M, Leis AA (1997) Spinal cord motoneuron excitability during isoflurane and nitrous oxide anesthesia. *Anesthesiology* 86:302–307

Index

A

Adenosine, 58
Alpha peak, 55, 56
Alpha-band, 197, 198, 203, 220, 221
Anesthesia, 1, 7–14, 167–170, 173, 175–184,
190, 191, 195, 196, 198–206, 214,
216, 218, 219, 221
dissociative, 173, 191, 192
hysteresis, 167–170, 176, 177, 183,
189–191
in sheep, 179, 184, 185, 187–189, 191
modeling, 167, 168, 170, 173, 191
propofol, 167, 169, 173–175, 179, 184–191
Anesthetic depth, 243, 245, 246
Anesthetic hysteresis, 167, 168, 176, 177, 183,
189–191
Anesthetic mechanisms, 8–11, 14
Arousal, 45, 56, 61, 62
Ascending arousal system, 45–47, 53, 57, 58,
65
Ascending arousal system model, *see*
Sleep–wake cycle

B

Benzodiazepine, 154–157
Beta buzz, 154, 162
Bi-phasic power spectrum, 232, 236, 238, 240
Biphasic response, 167, 168, 196–199,
201–205, 222
Burst suppression, 200, 218, 222

C

Circadian drive, *see* Sleep–wake cycle
Circadian rhythm, 113, 123
Coherence, 57
Computational models, 70, 76, 77, 81–84, 92,
93, 97, 99, 100

Cortical modelling, 21, 139, 167, 195, 227
Corticothalamic model, 50, 53, 58
Critical slowing, 169, 178

D

Delta-band, 198, 200, 205, 206, 217, 220
Dynamic-clamp, 61

E

EEG, 69–71, 75, 76, 91, 93, 96, 97, 99, 100,
142–146, 148, 150, 151, 153, 154,
156, 157, 160–163, 195–206, 211,
212, 214–217, 219, 221, 222, 227,
228, 232, 236–238, 240, 245–247,
250
EEG/fMRI, 130
Electrorhythmogenesis, 145
Epilepsy, 69, 70, 90

F

F wave, 248, 249
Fatigue, 62, 64
Firing rate model, 109, 111, 114
Fluctuation spectrum, 169, 179

G

GABAergic agonism, 144
General anaesthesia, 21, 22, 27, 28, 33–36,
141, 162, 227, 231, 234, 236, 238,
240

H

H reflex, 247–249
Hippocampo-neocortical dialogue, 133
Homeostatic drive, *see* Sleep–wake cycle
Hopf instability, 170, 179, 181–184, 190

I

Inhibitory post-synaptic potential, 28, 32–36
 Instability, 177–180, 183
 Hopf, 178–183, 190
 saddle-node, 179, 180
 Intracellular recordings, 69, 75, 76, 86, 97, 99
 Ionic channels, 206, 207, 211

L

Local field potential, 71–73, 85
 Loss of consciousness, 167, 169, 190

M

Mammalian sleep, 107, 108
 Mathematical model, 108, 121
 Mean-field model, 143–145, 150, 205–207,
 211, 220, 221
 linear instability, 55
 linear limit, 53
 of neuronal activity, 49, 52
 parameters, 51
 spectra, 55
 steady states, 53
 Mechanisms of anaesthesia, 162
 Memory, 101

N

Neural field model, 46, 47, 49, 57, 231, 232
 Neural mass, 143–145
 Neural population, 227–235, 237, 238, 240
 Neuromodulators, 23, 25–27, 34
 Nociception, 249, 250
 Nociceptive reflex, 249, 250, 254
 Non-rapid eye movement, 2–5, 7–10, 13
 NREM sleep, 127–131, 133, 134

O

Oscillations, 69–71, 73, 75–92, 97–99, 101,
 102

P

Pacemakers, 55

Pharmacodynamic interaction, 245, 246
 Phase transition, 167, 169, 170, 190
 Propofol, 229–234, 236, 239, 240

R

Rapid eye movement sleep, 2–9, 12, 13
 Reciprocal interaction, 110, 117, 118, 120,
 122, 123
 Recovery of consciousness, 168, 169, 190
 REM sleep, 108, 109, 113–116, 118, 119,
 121–124

S

Saddle-node bifurcation, 48, 55, 57, 59
 Sedation, 143, 144, 153
 Shiftwork, 65
 Sleep, 1–5, 7, 8, 10–14, 21–28, 31–33, 36,
 69–76, 90, 93, 97–99, 101, 102
 Sleep homeostasis, 13, 14
 Sleep–wake cycle, 58
 ascending arousal system model, 58
 circadian drive, 58
 homeostatic drive, 58
 physiological basis, 57
 spectral characteristics, 55
 Sleep–wake flip-flop, 110
 Slow oscillation, 128, 129, 131, 133
 Slow waves, 72–74, 76, 90, 93, 98, 99, 101,
 195, 200, 217, 220
 Spectra, *see* Mean-field model
 Spindles, 70, 71, 73, 75–77, 83, 84, 89, 90,
 97–102, 127–134
 Steady states, 53, 59
 Suprachiasmatic nucleus (SCN), 108, 110,
 113, 114, 116–118, 120, 121, 123
 Synaptic downscaling, 132

T

Thalamus, 50, 51, 55

V

Volume conduction, 49